

STANDARD RECOVERY DIODES

Stud Version

Features

- Diffused diode
- Wide current range
- High voltage ratings up to 1200V
- High surge current capabilities
- Stud cathode and stud anode version
- Hermetic metal case

320A

Typical Applications

- Welders
- Power supplies
- Machine tool controls
- High power drives
- Medium traction applications
- Battery charges
- Free-wheeling diodes

Major Ratings and Characteristics

| Parameters | 240U(R).. | Units |
|------------------|-------------|-------------------|
| $I_{F(AV)}$ | 320 | A |
| @ T_C | 100 | °C |
| $I_{F(RMS)}$ | 500 | A |
| I_{FSM} @ 50Hz | 4500 | A |
| @ 60Hz | 4700 | A |
| I^2t @ 50Hz | 101 | KA ² s |
| @ 60Hz | 92 | KA ² s |
| V_{RRM} range | 600 to 1200 | V |
| T_J | - 40 to 180 | °C |

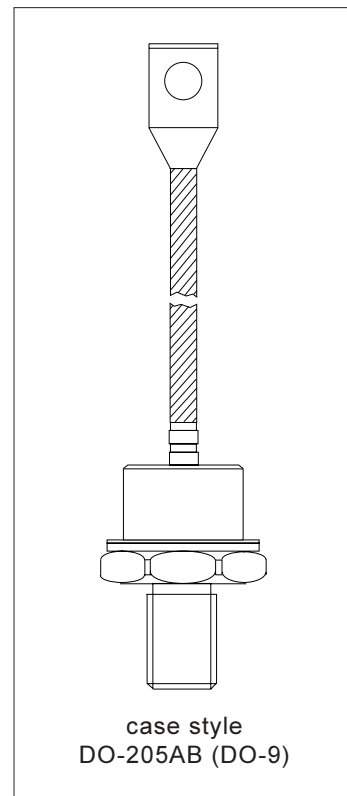

240U(R).. Series

Bulletin I2029 rev. D 09/03

International
IR Rectifier

ELECTRICAL SPECIFICATIONS

Voltage Ratings

| Type number | Voltage Code | V_{RRM} , maximum repetitive peak reverse voltage V | V_{RSM} , maximum non-repetitive peak rev. voltage V | I_{RRM} max. @ $T_J = T_J$ max. mA |
|-------------|--------------|--|---|--|
| 240U(R).. | 60 | 600 | 700 | 15 |
| | 80 | 800 | 900 | |
| | 100 | 1000 | 1100 | |
| | 120 | 1200 | 1300 | |

Forward Conduction

| Parameter | 240U(R).. | Units | Conditions |
|---|-----------|--------------------|---|
| $I_{F(AV)}$ Max. average forward current @ Case temperature | 320 | A | 180° conduction, half sine wave |
| | 100 | °C | |
| $I_{F(RMS)}$ Max. RMS forward current | 500 | A | DC @ 80°C case temperature |
| I_{FSM} Max. peak, one-cycle forward, non-repetitive surge current | 4500 | A | t = 10ms No voltage |
| | 4700 | | t = 8.3ms reapplied |
| | 3800 | | t = 10ms 100% V_{RRM} |
| | 4000 | | t = 8.3ms reapplied |
| I^2t Maximum I^2t for fusing | 101 | KA ² s | t = 10ms No voltage |
| | 92 | | t = 8.3ms reapplied |
| | 72 | | t = 10ms 100% V_{RRM} |
| | 66 | | t = 8.3ms reapplied |
| $I^2\sqrt{t}$ Maximum $I^2\sqrt{t}$ for fusing | 1010 | KA ² √s | t = 0.1 to 10ms, no voltage reapplied |
| r_f Slope resistance | 0.6 | mΩ | @ $T_J = T_J$ max. |
| $V_{F(T0)}$ Threshold voltage | 0.83 | V | |
| V_{FM} Max. forward voltage drop | 1.33 | V | $I_{pk} = 750A$, $T_J = 25^\circ C$, $t_p = 10ms$ sinusoidal wave |

Thermal and Mechanical Specifications

| Parameter | 240U(R).. | Units | Conditions |
|--|-----------------|---------------|--|
| T_J Max. junction operating temperature range | -40 to 180 | °C | |
| T_{stg} Max. storage temperature range | -40 to 180 | | |
| R_{thJC} Max. thermal resistance, junction to case | 0.18 | K/W | DC operation |
| R_{thCS} Max. thermal resistance, case to heatsink | 0.08 | | Mounting surface, smooth, flat and greased |
| T Max. allowed mounting torque +0-20% | 37 (330) | Nm (lb.in) | Not lubricated threads |
| | 28 (250) | | Lubricated threads |
| wt Approximate weight | 250 | g | |
| Case style | DO-205AB (DO-9) | | See Outline Table |

ΔR_{thJC} Conduction

(The following table shows the increment of thermal resistance R_{thJC} when devices operate at different conduction angles than DC)

| Conduction angle | Sinusoidal conduction | Rectangular conduction | Units | Conditions |
|------------------|-----------------------|------------------------|-------|------------------|
| 180° | 0.019 | 0.015 | K/W | $T_J = T_J$ max. |
| 120° | 0.023 | 0.025 | | |
| 90° | 0.030 | 0.034 | | |
| 60° | 0.045 | 0.047 | | |
| 30° | 0.076 | 0.076 | | |

Ordering Information Table

| | | | | | |
|--------------------|----------|----------|----------|------------|----------|
| Device Code | | | | | |
| 24 | 0 | U | R | 120 | D |
| 1 | 2 | 3 | 4 | 5 | 6 |

| | | | | |
|----------|---|---|---|--|
| 1 | - | 24 | = | Essential Part Number |
| 2 | - | 0 | = | Standard Device |
| 3 | - | U | = | Stud Normal Polarity (Cathode to Stud) |
| 4 | - | None | = | Stud Normal Polarity (Cathode to Stud) |
| | | R | = | Stud Reverse Polarity (Anode to Stud) |
| 5 | - | Voltage code: Code x 10 = V_{RRM} (See Voltage Ratings table) | | |
| 6 | - | Diffused diode | | |

Note = For Metric Device M16 x 1.5 Contact Factory

Outline Table

240U(R) Series
 Conforms to JEDEC DO-205AB (DO-9)
 All dimensions in millimeters (inches)

* FOR METRIC DEVICE: M16 X 1.5 CONTACT FACTORY
 FOR DIFFERENT LEAD CONTACT FACTORY

240U(R).. Series

Bulletin I2029 rev. D 09/03

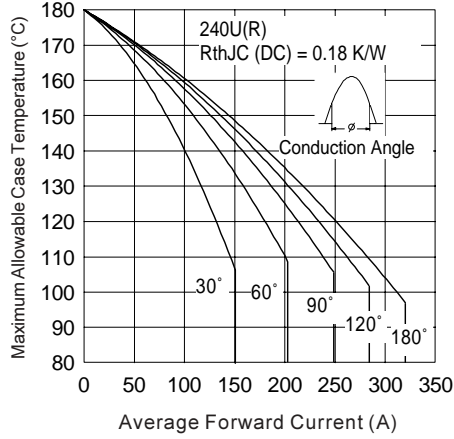

Fig. 1 - Current Ratings Characteristics

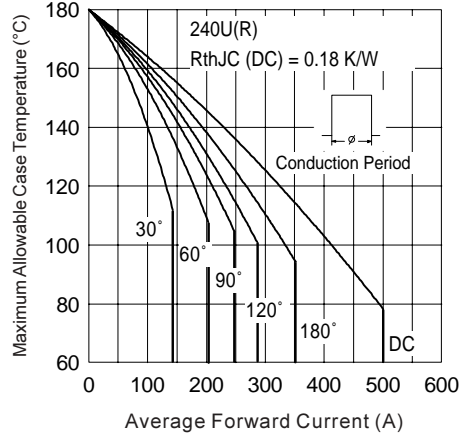

Fig. 2 - Current Ratings Characteristics

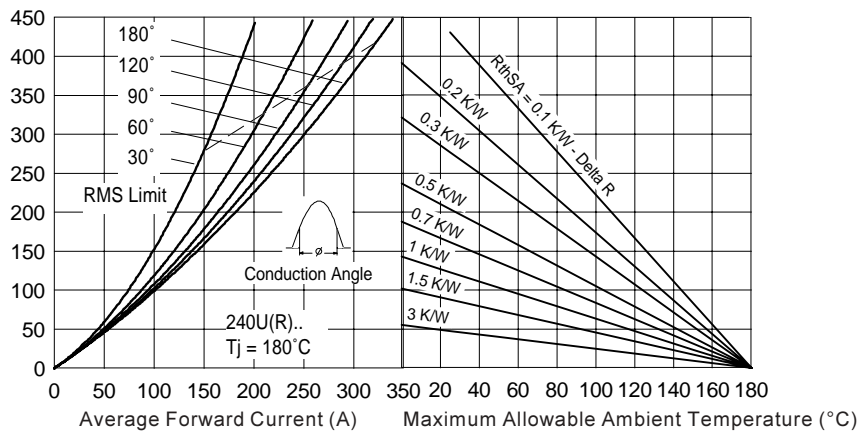

Fig. 3 - Forward Power Loss Characteristics

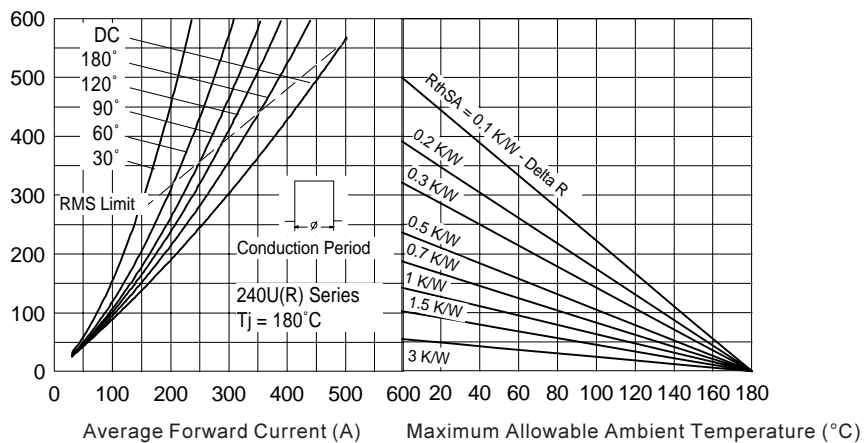

Fig. 4 - Forward Power Loss Characteristics

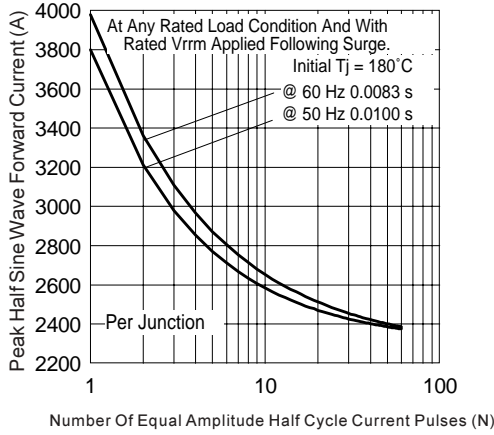

Fig. 5 - Maximum Non-Repetitive Surge Current

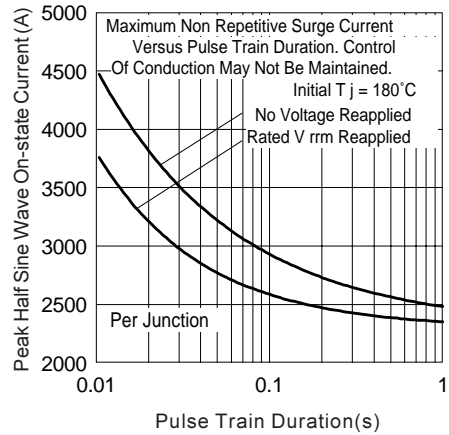

Fig. 6 - Maximum Non-Repetitive Surge Current

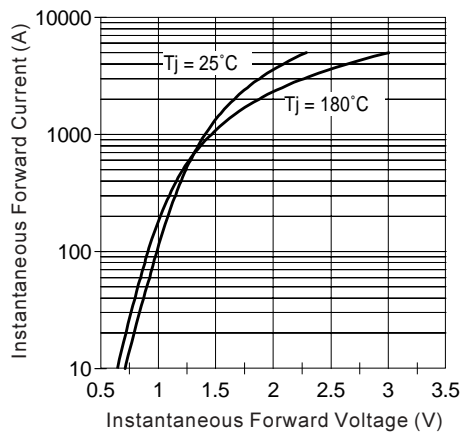

Fig. 7 - Forward Voltage Drop Characteristics

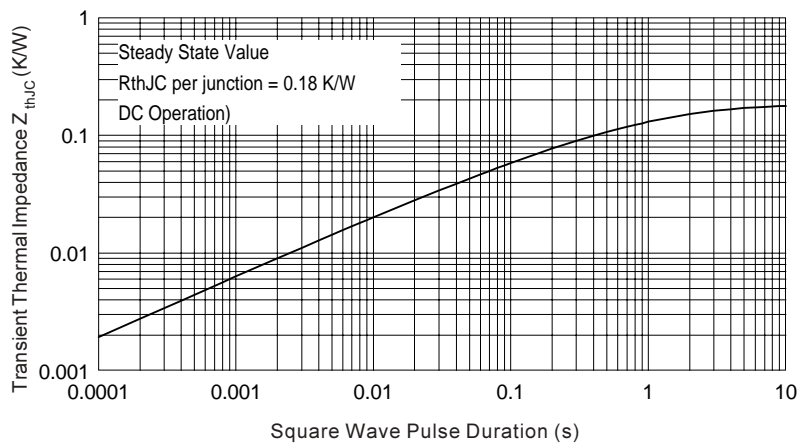

Fig. 8 - Thermal Impedance Z_{thJC} Characteristic

240U(R).. Series

Bulletin I2029 rev. D 09/03

International
IR Rectifier

Data and specifications subject to change without notice.
This product has been designed and qualified for Industrial Level.
Qualification Standards can be found on IR's Web site.

International
IR Rectifier

IR WORLD HEADQUARTERS: 233 Kansas St., El Segundo, California 90245, USA Tel: (310) 252-7105
TAC Fax: (310) 252-7309

Visit us at www.irf.com for sales contact information. 03/03