

AU OPTRONICS CORPORATION

Spec. No.: xxxx-xxx-xxx
Version: 1
Total pages: 4
Date: 2001-JUN-18

Tentative

Module Specification for 8,4" TFT-LCD MODULES

Model Name: B084SN01

Approved by	Checked by	Prepared by

Quality Management Division / AU Optronics Corporation

Customer	Checked & Approved by

AU copyright 2001,
All rights reserved,
Copying forbidden.

Contents:

A. Physical specification	P2
B. Electrical specifications	P3
1. Pin assignment.....	P3
2. Absolute maximum ratings.....	P4
3. Electrical characteristics.....	P5
a. Typical operating conditions.....	P5
b. Display color v. s. input data signals.....	P6
c. Input signal timing.....	P7
d. Display position.....	P7
e. Backlight driving conditions.....	P8
C. Optical specifications	P9
D. Reliability test items	P11
E. Display quality	P11
F. Handling precaution	P11
G. Packing form	P11
Appendix:	
Fig.1 LCM outline dimensions	P12
Fig.2 Timing chart.....	P13

A. Physical specifications

NO.	Item	Specification	Remark
1	Display resolution(pixel)	800(H)× 600(V)	
2	Active area(mm)	170.4(H)× 127.8(V)	
3	Screen size(inch)	8.4(Diagonal)	
4	Pixel pitch(mm)	0.213(H)× 0.213(V)	
5	Color configuration	R. G. B. Vertical stripe	
6	Overall dimension(mm)	203.0(W)× 142.5(H)× 5.7(D)	Note 1
7	Weight(g)	230 ± 10	

Note 1: Refer to Fig. 1.

B. Electrical specifications

1.Pin assignment

(1).Input signal interface

Pin no	Symbol	Function	Etc.
1	V _{CC}	+3.3 V power supply	
2	V _{CC}	+3.3 V power supply	
3	GND	Ground	
4	GND	Ground	
5	RxIN0-	LVDS receiver signal channel 0	
6	RxIN0+		
7	GND	Ground	
8	RxIN1-	LVDS receiver signal channel 1	
9	RxIN1+		
10	GND	Ground	
11	RxIN2-	LVDS receiver signal channel 2	
12	RxIN2+		
13	GND	Ground	
14	CKIN-	LVDS receiver signal clock	
15	CKIN+		
16	GND	Ground	
17	NC	No Connection	
18	NC	No Connection	
19	GND	Ground	
20	GND	Ground	

CN1 (20P) connector: HRS DF 19K-20P-1H or Compatible

(2) LVDS transmitter/receiver signal mapping

	Symbol	Function	
TxIN0	R0	Red data (LSB)	6 bit red display data
TxIN1	R1	Red data	
TxIN2	R2	Red data	
TxIN3	R3	Red data	
TxIN4	R4	Red data	
TxIN5	R5	Red data (MSB)	
TxIN6	G0	Green data (LSB)	6 bit green display data
TxIN7	G1	Green data	
TxIN8	G2	Green data	
TxIN9	G3	Green data	
TxIN10	G4	Green data	
TxIN11	G5	Green data (MSB)	
TxIN12	B0	Blue data (LSB)	6 bits blue display data
TxIN13	B1	Blue data	
TxIN14	B2	Blue data	
TxIN15	B3	Blue data	
TxIN16	B4	Blue data	
TxIN17	B5	Blue data (MSB)	
TxIN18	Hs	Horizontal sync	
TxIN19	Vs	Vertical sync	
TxIN20	DE	Data enable	
TxCLKIN	CLK	Clock	Dot clock

2. Absolute maximum ratings

(GND = 0 V)

Parameter	Symbol	Values		Unit	Remark
		Min.	Max.		
Power voltage	V_{CC}	-0.3	4	V_{DC}	At 25°C
Input signal voltage	V_{LH}	-0.3	$V_{CC}+0.3$	V_{DC}	At 25°C
Operating temperature	Top	0	+60	°C	Note 1
Storage temperature	T_{ST}	-20	+70	°C	Note 1

Note 1: The relative humidity must not exceed 90% non-condensing at temperatures of 40°C or less. At temperatures greater than 40°C, the wet bulb temperature must not exceed 39°C. When operate at low temperatures, the brightness of CCFL will drop and the lifetime of CCFL will be reduced.

Note 2: The unit should not be exposed to corrosive chemicals.

3. Electrical characteristics

a. Typical operating conditions

	Item	Symbol	Min.	Typ.	Max.	Unit	Remark
Power supply voltage	Input voltage	V_{CC}	3.0	3.3	3.6	V	
	Current consumption	I_A		310		mArms	Note 1
		I_B			330		
	Inrush current	I_{RUSH}	-	-	1500	mApeak	Note 2
Internal logic	Low voltage	V_{IL}	0	-	$0.3 V_{CC}$		
	High voltage	V_{IH}	$0.7 V_{CC}$	-	V_{CC}		
	Power ripple voltage	V_{RP}	-	-	100	mVp-p	

Note 1: Effective value (mArms) at $V_{CC} = 3.3 V/25^{\circ}C$.

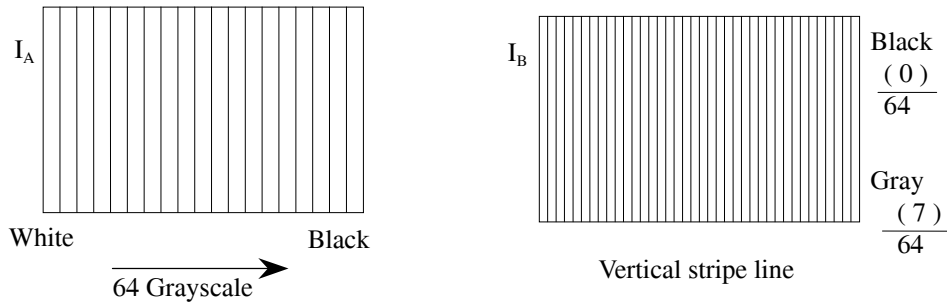

Note 2: Refer to the following power-on condition.

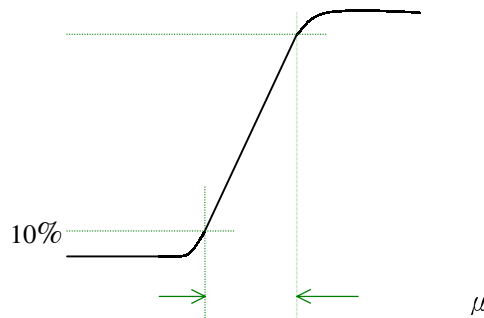

Sequence of Power-on/off and signal-on/off

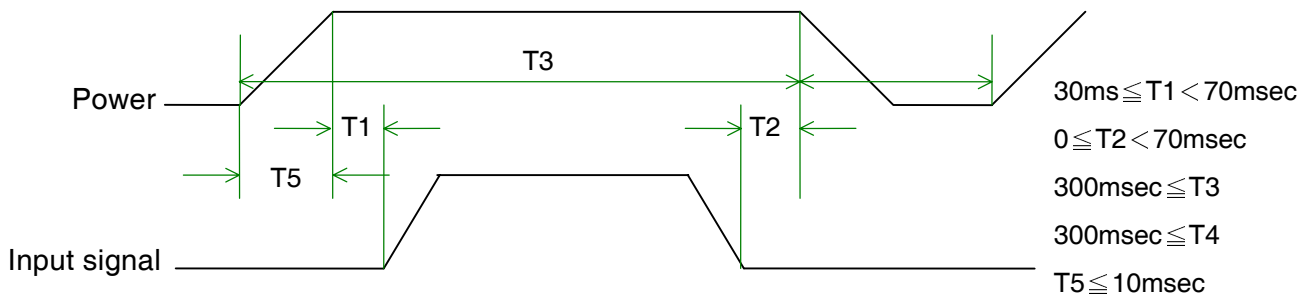

Apply the lamp voltage within the LCD operating range. When the backlight turns on before the LCD operation or the LCD turns off before the backlight turns off, the display may momentarily become abnormal.

Caution

The above on/off sequence should be applied to avoid abnormal function in the display.

In case of handling:

Make sure to turn off the power when you plug the cable into the input connector or pull the cable out of the connector.

b. Display color vs. input data signals

Display colors		Data signal (0 : Low level, 1: High level)																	
		R5	R4	R3	R2	R1	R0	G5	G4	G3	G2	G1	G0	B5	B4	B3	B2	B1	B0
Basic colors	Black	0	0	0	0	0	0	0	0	0	0	0	0	0	0	0	0	0	0
	Blue	0	0	0	0	0	0	0	0	0	0	0	0	1	1	1	1	1	1
	Red	1	1	1	1	1	1	0	0	0	0	0	0	0	0	0	0	0	0
	Magenta	1	1	1	1	1	1	0	0	0	0	0	0	1	1	1	1	1	1
	Green	0	0	0	0	0	0	1	1	1	1	1	1	0	0	0	0	0	0
	Cyan	0	0	0	0	0	0	1	1	1	1	1	1	1	1	1	1	1	1
	Yellow	1	1	1	1	1	1	1	1	1	1	1	1	0	0	0	0	0	0
	White	1	1	1	1	1	1	1	1	1	1	1	1	1	1	1	1	1	1
Red grayscale	Black	0	0	0	0	0	0	0	0	0	0	0	0	0	0	0	0	0	0
	Dark	0	0	0	0	0	1	0	0	0	0	0	0	0	0	0	0	0	0
	↕																		
	bright																		
		1	1	1	1	0	1	0	0	0	0	0	0	0	0	0	0	0	0
	Red	1	1	1	1	1	0	0	0	0	0	0	0	0	0	0	0	0	0
Green grayscale	Black	0	0	0	0	0	0	0	0	0	0	0	0	0	0	0	0	0	0
	Dark	0	0	0	0	0	0	0	0	0	0	0	1	0	0	0	0	0	0
	↕																		
	bright																		
		0	0	0	0	0	0	1	1	1	1	0	1	0	0	0	0	0	0
	Green	0	0	0	0	0	0	1	1	1	1	1	1	0	0	0	0	0	0
Blue grayscale	Black	0	0	0	0	0	0	0	0	0	0	0	0	0	0	0	0	0	0
	Dark	0	0	0	0	0	0	0	0	0	0	0	0	0	0	0	0	0	1
	↕																		
	bright																		
		0	0	0	0	0	0	0	0	0	0	0	0	1	1	1	1	0	1
	Blue	0	0	0	0	0	0	0	0	0	0	0	0	1	1	1	1	1	1

Note: Each basic color can be displayed in 64 gray scales using the 6 bit data signals. By combining the 18-bit data signals(R, G, B), the 262, 144 colors can be achieved on the display.

c. Input signal timing

Timing diagrams of input signal are shown in Fig 2.

(1). Timing characteristics of input signals

DE mode

Item	Symbol	Min.	Typ.	Max.	Unit	Remark
Clock frequency	Fck	38	40	42	MHz	
Horizontal blanking	Thb1	235	256	500	Clk	
Vertical blanking	Tvb1	10	28	150	Th	

(2). The timing condition of LVDS

Item	Symbol	Min.	Typ.	Max.	Unit
The differential level	VID	0.1	-	0.6	V
The common mode input voltage	VIC	$\frac{ VID }{2}$	-	$2.4 - \frac{ VID }{2}$	V
The input setup time	tsu1	0.5	-	-	ns
The input hold time	th1	0.5	-	-	ns

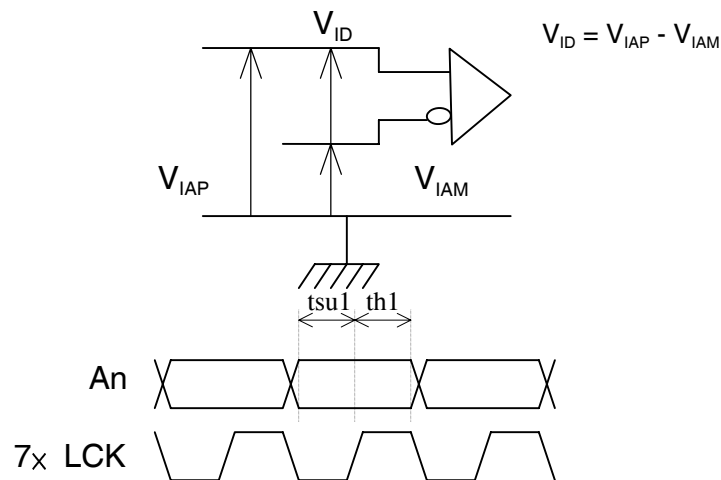

d. Display position

D(1,1)	D(2,1)	D(X,1)	D(799,1)	D(800,1)
D(1,2)	D(2,2)	D(X,2)	D(799,2)	D(800,2)
⋮		⋮	⋮	⋮
D(1,Y)	D(2,Y)	D(X,Y)	D(799,Y)	D(800,Y)
⋮		⋮	⋮	⋮
D(1,599)	D(2,599)	D(X,599)	D(799,599)	D(800,599)
D(1,600)	D(2,600)	D(X,600)	D(799,600)	D(800,600)

e. Backlight driving conditions

Parameter	Symbol	Min.	Typ.	Max.	Unit	Remark
Lamp voltage	V_L	-	(505)	-	Vrms	Note 1
Lamp current	I_L	-	4.6	-	mArms	Note 1
Power consumption	P_L	-	(2.3)	-	W	Note 2
Lamp starting voltage	V_s		750		Vrms	T=0°C
			550			T=25°C
Frequency	F_L	-	60	-	KHz	Note 3
Lamp life time	L_L	10000	20000	-	Hr	Note 1, 4

Note 1: T= 25°C

Note 2: Inverter should be designed with the characteristic of lamp. When you are designing the inverter, the output voltage of the inverter should comply with the following conditions.

- (1). The area under the positive and negative cycles of the waveform of the lamp current and lamp voltage should be area symmetric(the symmetric ratio should be larger than 90%).
- (2). There should not be any spikes in the waveform.
- (3). The waveform should be sine wave as possible.
- (4). Lamp current should not exceed the maximum value within the operating temperature (It is prohibited to over the maximum lamp current even if operated in the non-guaranteed temperature). When lamp current over the maximum value for a long time, it may cause fire. Therefore, it is recommend that the inverter should have the current limit circuit.

Note 3: Lamp frequency may produce interference with horizontal synchronous frequency and this may cause line flow on the display. Therefore lamp frequency shall be detached from the horizontal synchronous frequency and its harmonics as far as possible in order to avoid interference. In case using the inverter by PWM control, PWM frequency may interference with frame frequency. We suggest that PWM frequency is same as frame frequency.

Note 4: Brightness to be decrease to the 50% of the initial value.

Note 5: CN2 connector (backlight): BHSR-02VS-1(JST)

Mating connector: SM02B-BHSS-1-TB (JST)

Pin no.	Symbol	Function	Remark
1	H	CCFL power supply(H.V.)	Cable color: Pink
2	L	CCFL power supply(GND)	Cable color: White

C. Optical specifications (Note 1, Note 2, Note 3)

Item	Symbol	Condition	Specification			Unit	Remark
			Min.	Typ.	Max.		
Response time Rising time Falling time	Tr Tf	$\theta = 0^\circ$	- - -	20 30	40 50	ms	Note 4
Contrast ratio	CR	$\theta = 0^\circ$	150	200	-		Note 5
Viewing angle Top Bottom Left Right		$CR \geq 10$	30 10 40 40	- - - -	- - - -	deg.	Note 8
Brightness	Y_L	$\theta = 0^\circ$	-	150	-	nit	Note 6,7
Color chromaticity(CIE)	Wx	$\theta = 0^\circ$	-	0.310	-		
	Wy		-	0.330	-		
	Rx		-	-	-		
	Ry		-	-	-		
	Gx		-	-	-		
	Gy		-	-	-		
	Bx		-	-	-		
	By		-	-	-		
White uniformity	δ_w		-	-	1.8		Note 9

Note 1: Ambient temperature = 25°C.

Note 2: To be measured in dark room after backlight warm up 30 minutes.

Note 3: To be measured with a viewing cone of 1° by Topcon luminance meter BM-5A.

Note 4: Definition of response time:

The output signals of photodetector are measured when the input signals are changed from "Black" to "White" (falling time) and from "White" to "Black" (rising time), respectively. The response time interval between the 10% and 90% of amplitudes. Refer to figure as below.

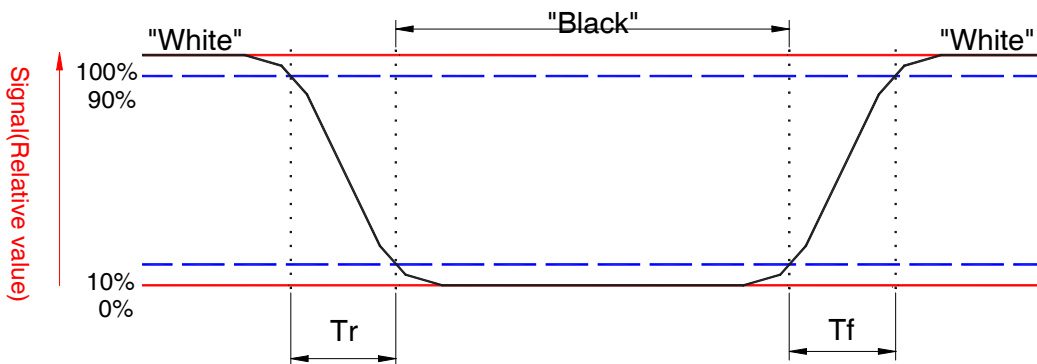

Note 5. Definition of contrast ratio:

Contrast ratio is calculated with the following formula.

$$\text{Contrast ratio (CR)} = \frac{\text{Photodetector output when LCD is at "White" state}}{\text{Photodetector output when LCD is at "Black" state}}$$

Note 6: Definition of brightness: This shall be measured at center of the screen.

Note 7: Driving conditions for CCFL : $I_L = (4.6) \text{ mA}, 60\text{KHz}$ Frequency

Note 8: Definition of viewing angle:

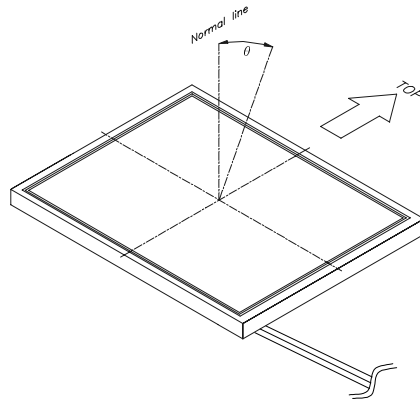

Note 9: Definition of white uniformity:

White uniformity is defined as the following with thirteen measurements (1~9).

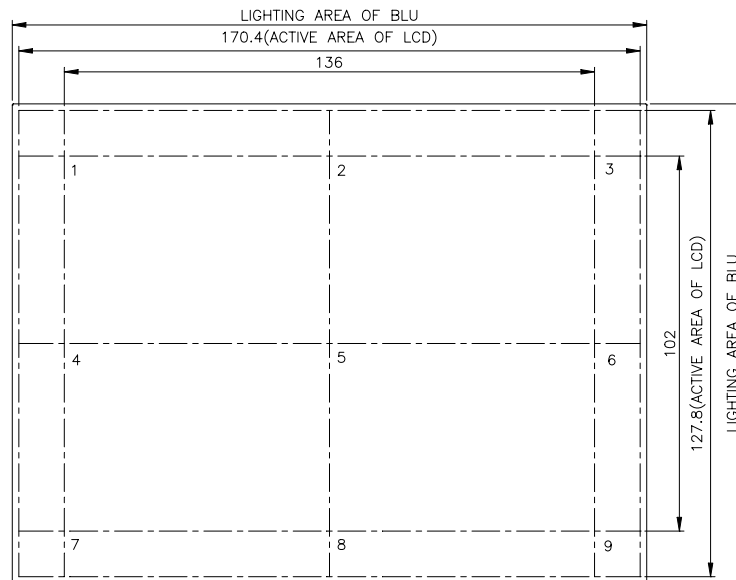

$$\delta = \frac{\text{Maximum Luminance of nine points}}{\text{Minimum Luminance of nine points}}$$

D. Reliability test items (Note 1)

Test tem	Test Condition	Remark
High temperature storage	70°C , 240Hrs	Note 1, 2, 3
Low temperature storage	-20°C , 240Hrs	Note 1, 2, 3
High temperature & high humidity operation	40°C , 90%RH, 240Hrs (No condensation)	Note 1, 2, 3
High temperature operation	60°C , 240Hrs	Note 1, 2, 3
Low temperature operation	0°C , 240Hrs	Note 1, 2, 3
Temperature cycling (non-operation)	-20°C ~70°C 1H, 10mins, 1H, 5cycles	Note 1, 2, 3
Electrostatic discharge (non-operation)	150 pF,150Ω ,10kV,1 second, 9 position on the panel, 10 times each place	Note 3
Vibration (non-operation)	Sweep:1G, 10Hz ~ 500Hz ~ 10Hz/2.5min 2 hour for each direction X, Y, Z (6 Hrs in total)	Note 1, 2, 3
Mechanical shock (non-operation)	50G/11ms, 200G/2ms, ± X, ± Y, ± Z once for each direction	Note 1, 2, 3

Note 1: Evaluation should be tested after storage at room temperature for one hour.

Note 2: There should be no change which might affect the practical display function when the display quality test is conducted under normal operating condition.

Note 3: Judgement : 1.Function OK.

2.No serious image quality degradation .

E. Display quality

The display quality of the color TFT-LCD module should be in compliance with the AU Optronics OQC inspection standard.

F. Handling precaution

The Handling of the TFT-LCD should be in compliance with the AU Optronics handling principle standard.

G. Packing form :

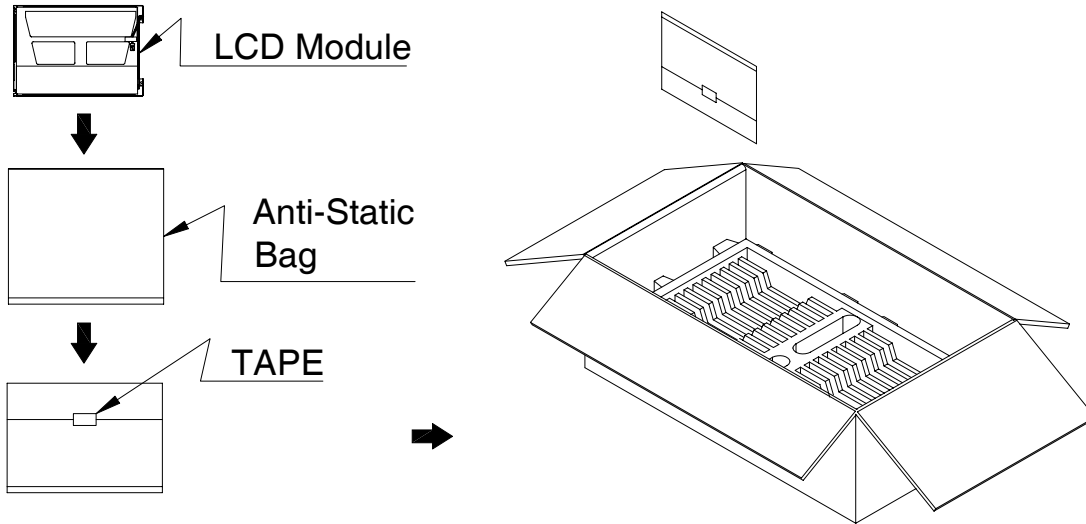

NOTE :

- 1. Max. Capacity : 30 LCD Modules/Carton.
- 2. Max. Weight : 10 Kg/Carton.
- 3. Meas : 600 mm*353mm*210mm.

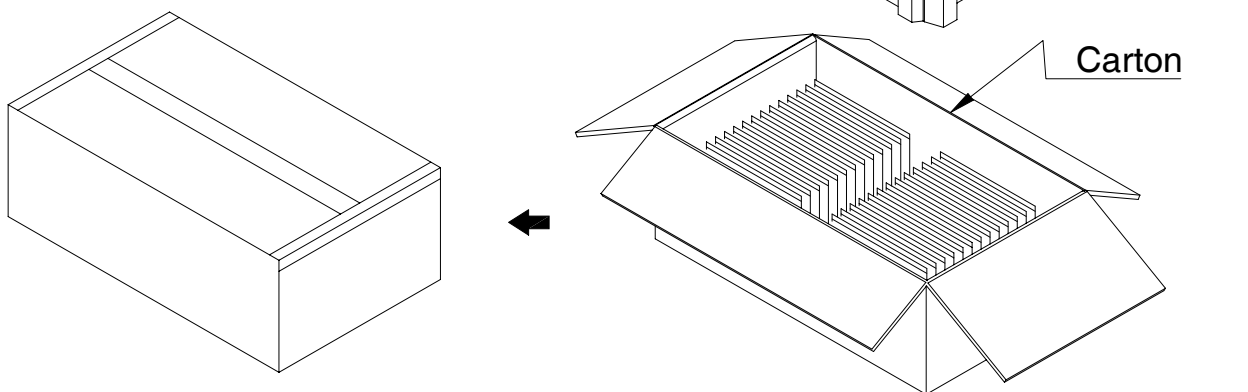

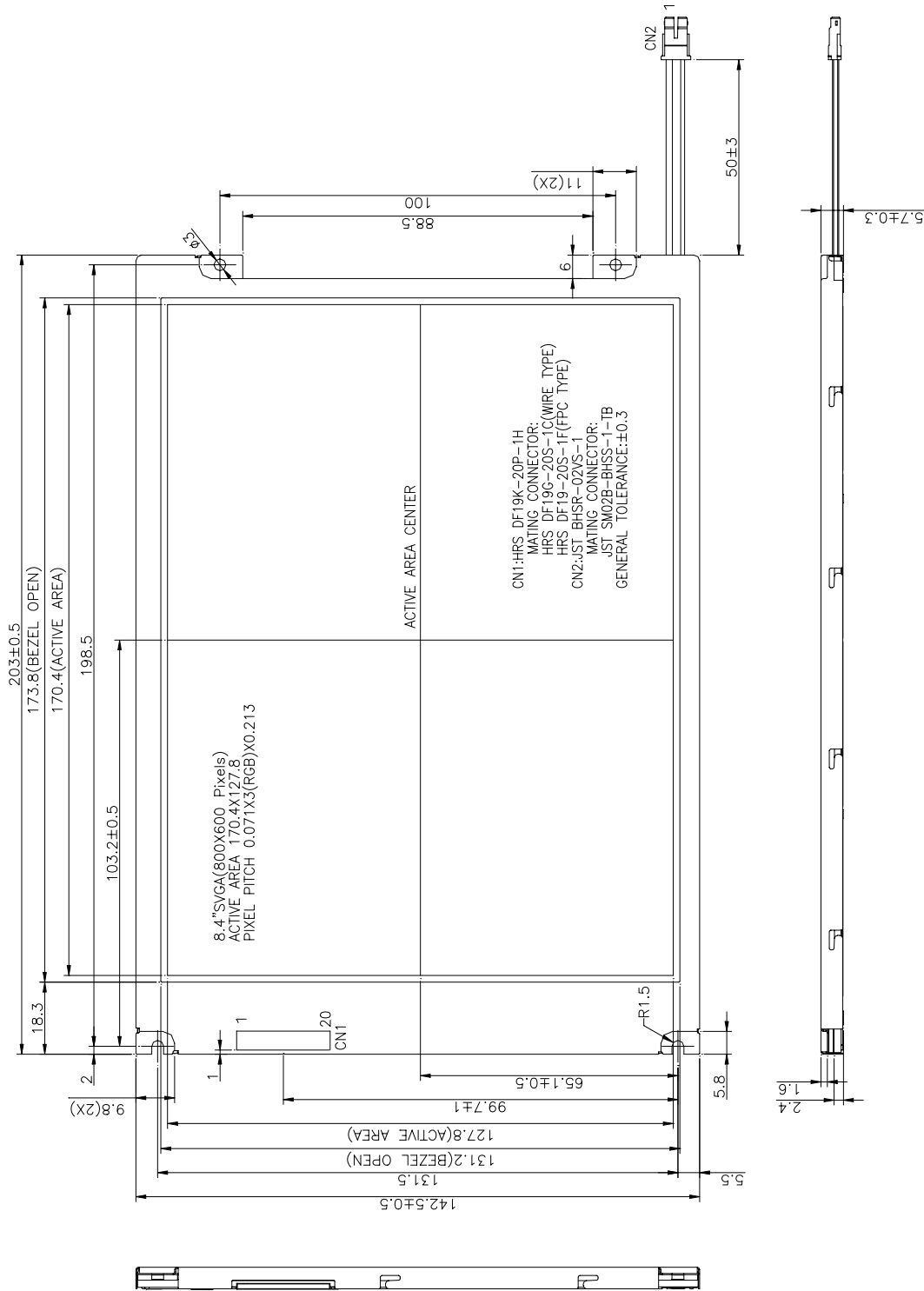

Fig.1 LCM outline dimensions

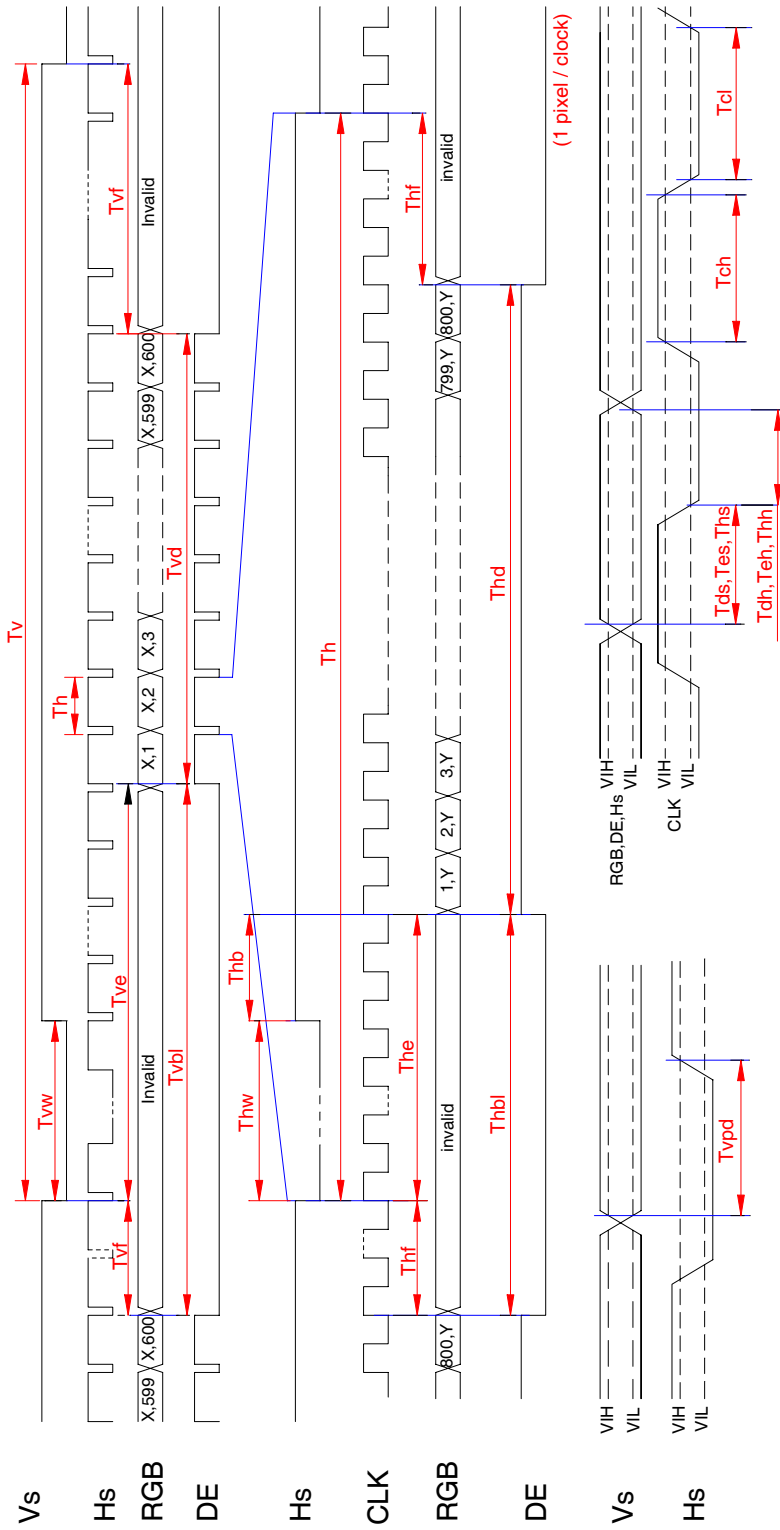

Fig.2 Timing chart