

**Recommended Operating Conditions**

	9LS/54LS			9LS/74LS			Unit
	Min.	Typ.	Max.	Min.	Typ.	Max.	
Supply voltage, $V_{CC}$	4.5	5.0	5.5	4.75	5.0	5.25	V
High level output current, $I_{OH}$			-400			-400	$\mu$ A
Low-level output current, $I_{OL}$			4			8	mA
Operating free-air temperature, $T_A$	-55		+125			70	$^{\circ}$ C

**Electrical Characteristics Over Recommended Operating Free-Air Temperature Range (Unless Otherwise Noted)**

Parameter	Test Conditions <sup>†</sup>	9LS/54LS			9LS/74LS			Unit
		Min.	Typ.	Max.	Min.	Typ.	Max.	
$V_{T+}$ Positive-going threshold voltage	$V_{CC} = 5V$	1.4	1.6	1.9	1.4	1.6	1.9	V
$V_{T-}$ Negative-going threshold voltage	$V_{CC} = 5V$	0.5	0.8	1.0	0.5	0.8	1.0	V
Hysteresis ( $V_{T+} - V_{T-}$ )	$V_{CC} = 5V$	0.4	0.8		0.4	0.8		V
$V_{IK}$ Input clamp voltage	$V_{CC} = \text{MIN}, I_I = -18\text{mA}$		-0.65	-1.5		-0.65	-1.5	V
$V_{OH}$ High-level output voltage	$V_{CC} = \text{MIN}, I_{OH} = \text{MAX}, V_I = V_{T\_MIN}$	2.5	3.4		2.7	3.4		V
$V_{OL}$ Low-level output voltage	$V_{CC} = \text{MIN}, V_I = V_{T+MAX}, I_{OL} = \text{MAX}$		0.25	0.40		0.35	0.50	V
$I_{T+}$ Input current at positive-going threshold	$V_{CC} = 5V, V_I = V_{T+}$		-0.14			-0.14		mA
$I_{T-}$ Input current at negative-going threshold	$V_{CC} = 5V, V_I = V_{T-}$		-0.18			-0.18		mA
$I_I$ Input current at maximum input voltage	$V_{CC} = \text{MAX}, V_I = 7V$			0.1			0.1	mA
$I_{IH}$ High-level input current	$V_{CC} = \text{MAX}, V_I = 2.7V$			20			20	$\mu$ A
$I_{IL}$ Low-level input current	$V_{CC} = \text{MAX}^*, V_{IL} = 0.4V$			-0.4			-0.4	mA
$I_{OS}$ Short-circuit output current	$V_{CC} = \text{MAX}$		-15	-100		-15	-100	mA
$I_{CCH}$ Supply Current High	$V_{CC} = \text{MAX}, V_{IN} = 0V$		8.6	16		8.6	16	mA
$I_{CCL}$ Supply Current Low	$V_{CC} = \text{MAX}, V_{IN} = 4.5V$		12	21		12	21	mA

<sup>†</sup>For conditions shown as MIN or MAX, use the appropriate value specified under recommended operating conditions.

### Switching Characteristics $V_{CC} = 5.0V$ Over Recommended Free-Air Temperature Range.

Parameter	From (Input)	To (Output)	9LS/54LS									Units
			-55°C			+25°C			+125°C			
			Min.	Typ.	Max.	Min.	Typ.	Max.	Min.	Typ.	Max.	
<b>Test Conditions: <math>C_L = 15pF</math>, <math>R_L = 2.0k</math> (See Fig. A, page 2-174)</b>												
$t_{PLH}$	A or B	Y		16	24		13	20		16	24	ns
$t_{PHL}$				16	24		13	20		16	24	ns
<b>Test Conditions: <math>C_L = 50pF</math>, <math>R_L = 2.0k</math> (See Fig. A, page 2-174)</b>												
$t_{PLH}$	A or B	Y		20	29		17	25		20	29	ns
$t_{PHL}$				20	29		17	25		20	29	ns

### PARAMETER MEASUREMENT INFORMATION

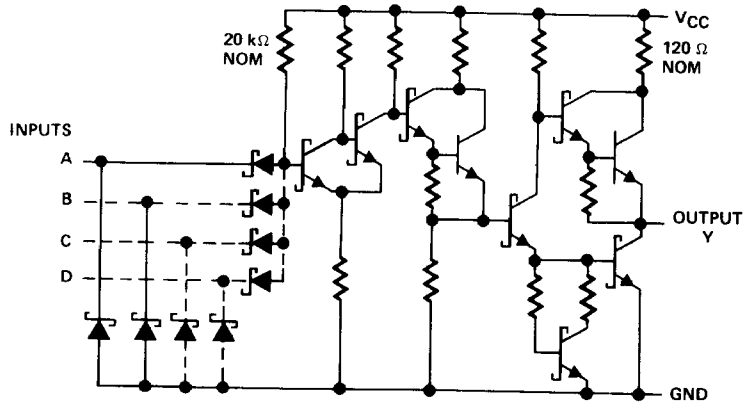
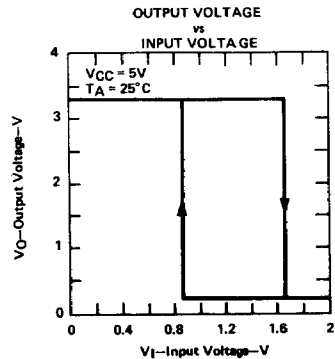
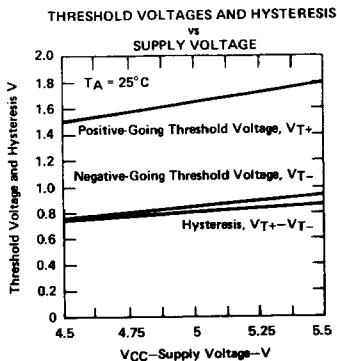
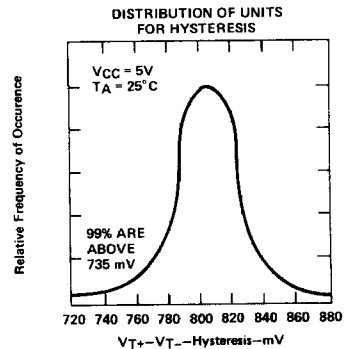
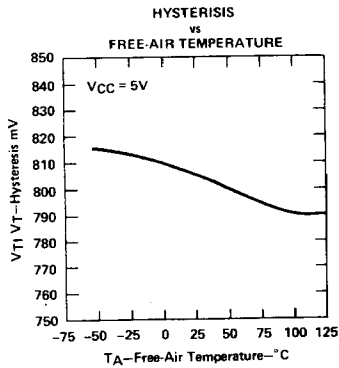
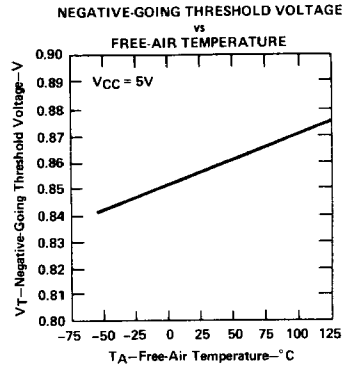
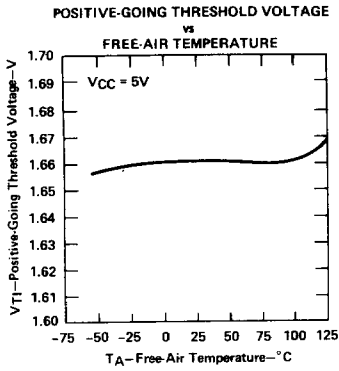

FIGURE 1

TYPICAL CHARACTERISTICS



## TYPICAL APPLICATIONS DATA

