

**2SD330,
331**

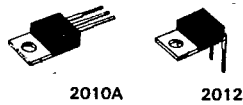

NPN/PNP Triple Diffused Planar Silicon Transistors

T-33-09

**2SB514,
515**

Low Frequency Power Amp Applications

©397D

Especially suited for use in output stage of 10W AF Power amp. The only difference between B514 and D515 lies in package design; and the same is true of D330 and D331. The B514 and D330 can be connected to form a complementary pair; and the same is true of B515 and D331.

() : 2SB514, 514.

Absolute Maximum Ratings at $T_a=25^\circ\text{C}$

			unit
Collector to Base Voltage	V_{CB0}	(-)50	V
Collector to Emitter Voltage	V_{CE0}	(-)50	V
Emitter to Base Voltage	V_{EB0}	(-)5	V
Collector Current	I_C	(-)2	A
Peak Collector Current	i_{cp}	(-)5	A
Collector Dissipation	P_C	1.75	W
	$T_C=25^\circ\text{C}$	20	W
Junction Temperature	T_j	150	$^\circ\text{C}$
Storage Temperature	T_{stg}	-55 to +150	$^\circ\text{C}$

Electrical Characteristics at $T_a=25^\circ\text{C}$

			min	typ	max	unit
Collector Cutoff Current	I_{CBO}	$V_{CB}=(-)20\text{V}, I_E=0$		(-)0.1		mA
Emitter Cutoff Current	I_{EBO}	$V_{EB}=(-)4\text{V}, I_C=0$		(-)1.0		mA
DC Current Gain	$h_{FE}(1)$	$V_{CE}=(-)2\text{V}, I_C=(-)1\text{A}$	40*		320*	
	$h_{FE}(2)$	$V_{CE}=(-)2\text{V}, I_C=(-)0.1\text{A}$	35			
Gain Bandwidth Product	f_T	$V_{CE}=(-)5\text{V}, I_C=(-)0.5\text{A}$		8		MHz
C-E Saturation Voltage	$V_{CE(sat)}$	$I_C=(-)2\text{A}, I_B=(-)0.2\text{A}$		(-)1.0		V
Base to Emitter Voltage	V_{BE}	$I_C=(-)1\text{A}, V_{CE}=(-)5\text{V}$		(-)1.5		V

* The 2SB514, 515/2SD330, 331 are classified by 1A h_{FE} as follows

40	C	80	60	D	120	100	E	200	160	F	320
----	---	----	----	---	-----	-----	---	-----	-----	---	-----

Case Outline 2010A
(unit:mm) [2SB514/2SD330]

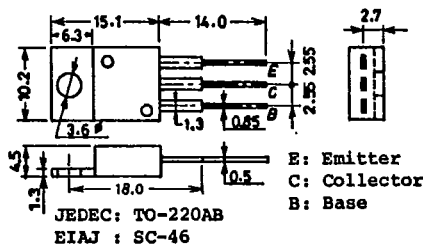

Case Outline 2012
(unit:mm) [2SB515/2SD331]

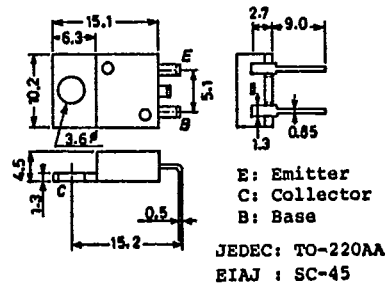

The 2SB515/D331 are scheduled to be discontinued soon. Use the 2SB514/D330, instead of the 2SB515/D331, in new applications where you are planning to use the 2SB515/D331.

3257AT/7193KI, TS No. 397-1/3

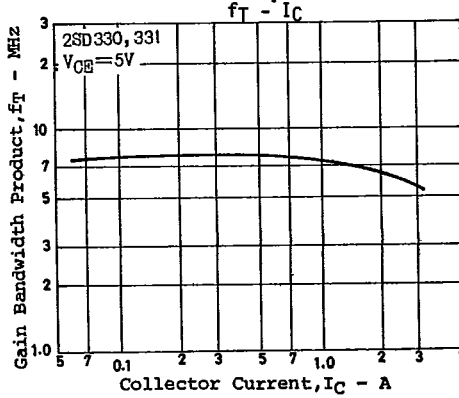
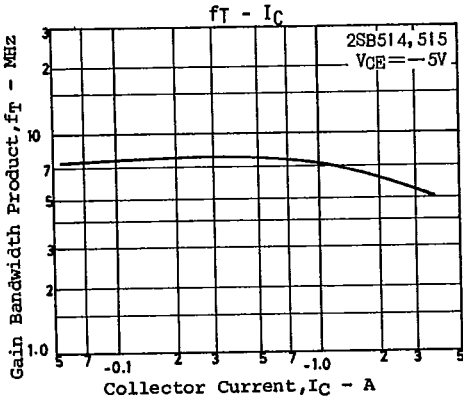
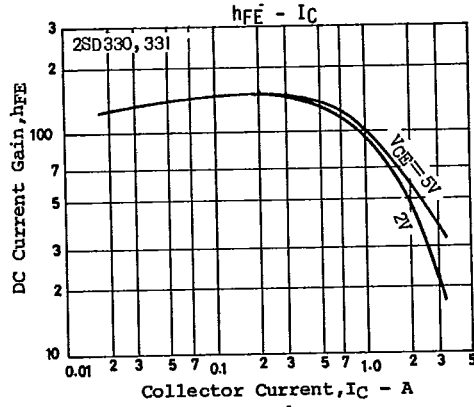
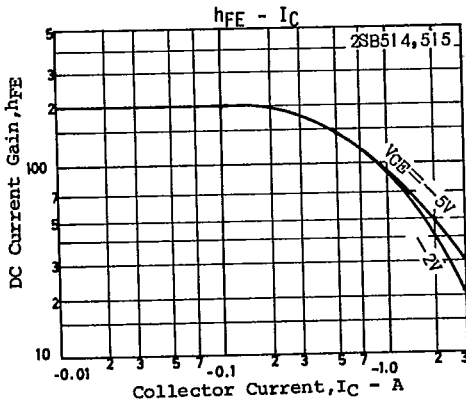
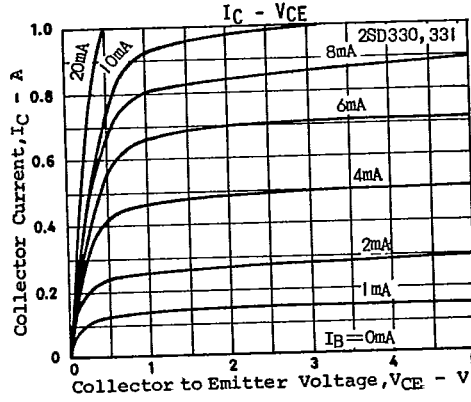
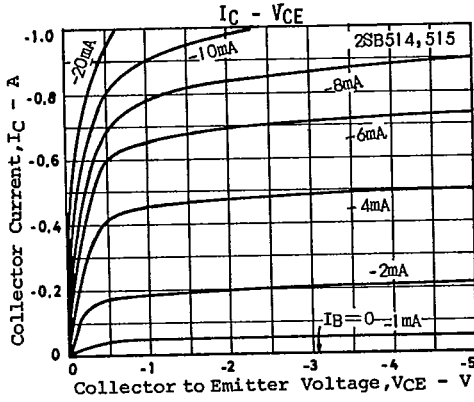
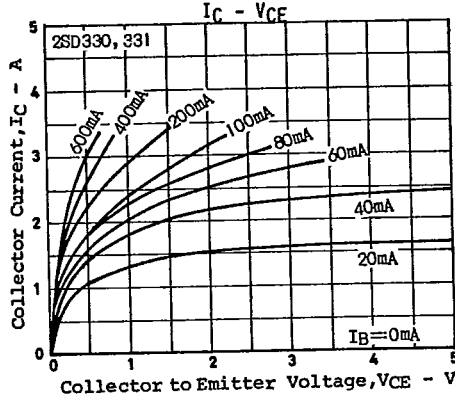
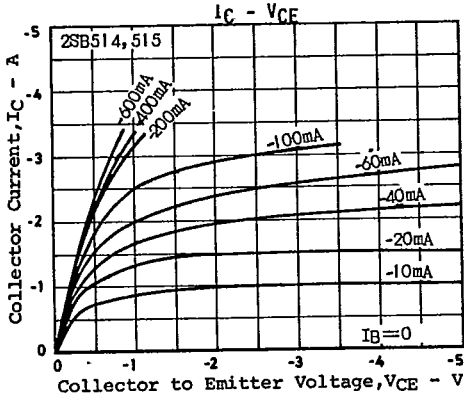

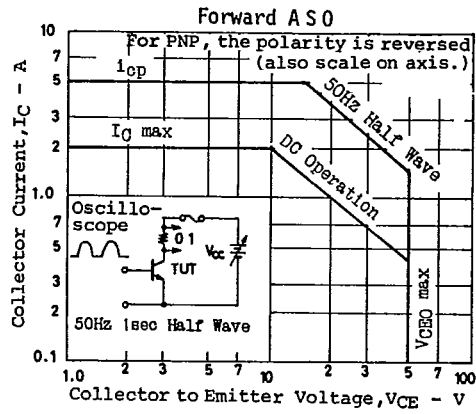
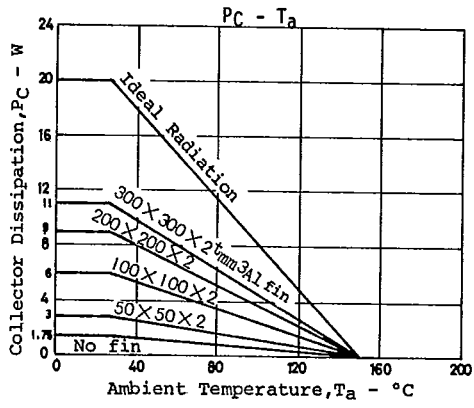

T-91-20

CASE OUTLINES AND ATTACHMENTS

- All of Sanyo Transistor case outlines are illustrated below.
- All dimensions are in mm, and dimensions which are not followed by min. or max. are represented by typical values.
- No marking is indicated.

Case Outline-[2003A]

unit:mm

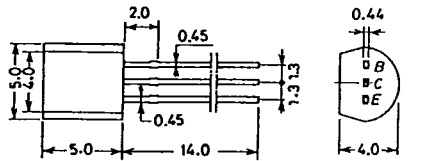

JEDEC: TO-92
EIAJ: SC-43
SANYO: NP

B. Base
C. Collector
E. Emitter

Case Outline-[2009A]

unit:mm

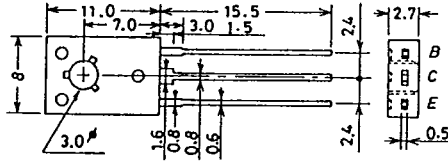

JEDEC: TO-126

B: Base
C: Collector
E: Emitter

Case Outline-[2004A]

unit:mm

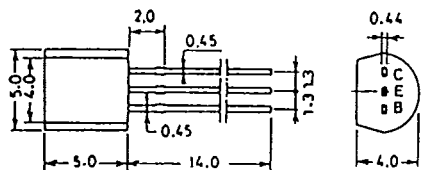

JEDEC: TO-92
EIAJ: SC-43
SANYO: NP

C. Collector
E. Emitter
B. Base

Case Outline-[2010A]

unit:mm

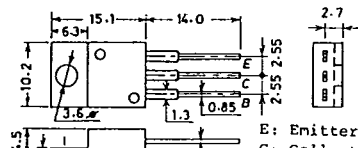

JEDEC: TO-220AB
EIAJ: SC-46

E: Emitter
C: Collector
B: Base

Case Outline-[2005A]

unit:mm

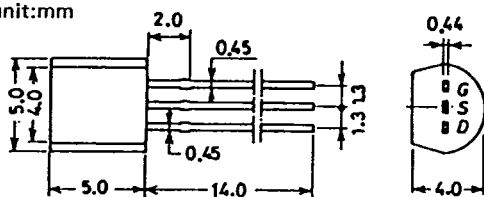

JEDEC: TO-92
EIAJ: SC-43
SANYO: NP

G: Gate
S: Source
D: Drain
B: Base
C: Collector

Case Outline-[2012]

unit:mm

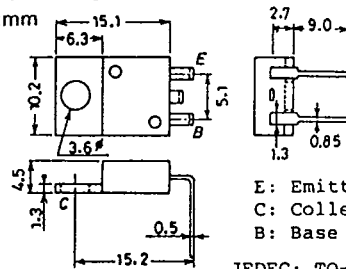

JEDEC: TO-220AA
EIAJ: SC-45

E: Emitter
C: Collector
B: Base

Case Outline-[2006A]

unit:mm

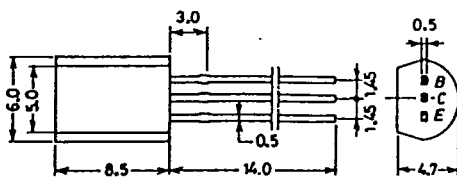

EIAJ: SC-51
SANYO: MP

B: Base
C: Collector
E: Emitter

Case Outline-[2013]

unit:mm

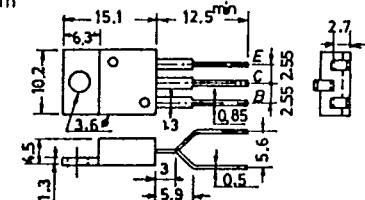

JEDEC TO-220

B: Base
C: Collector
E: Emitter

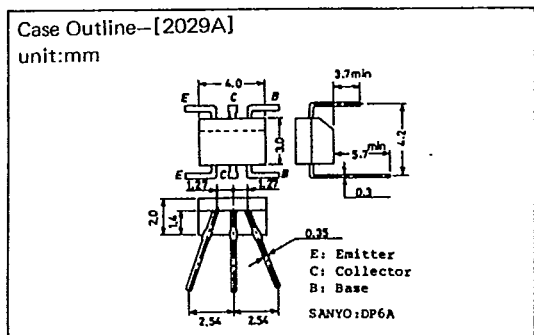
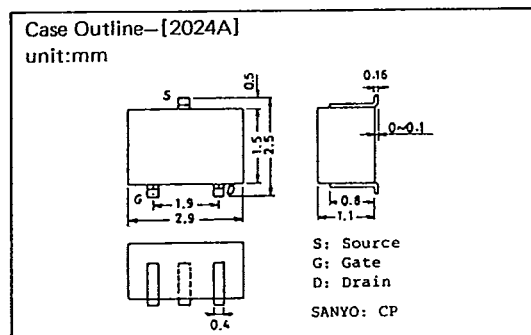
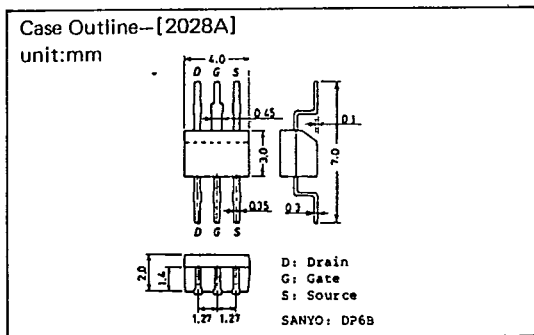
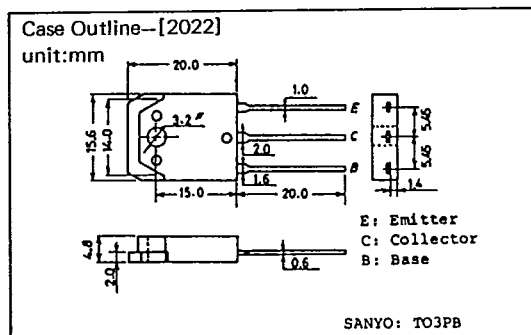
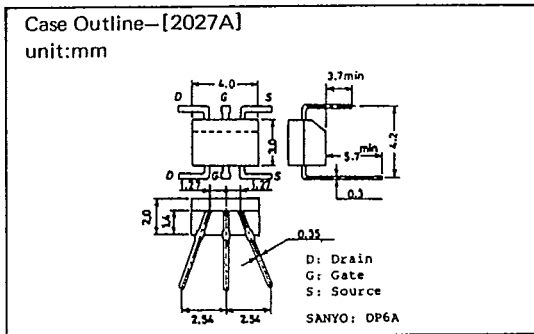
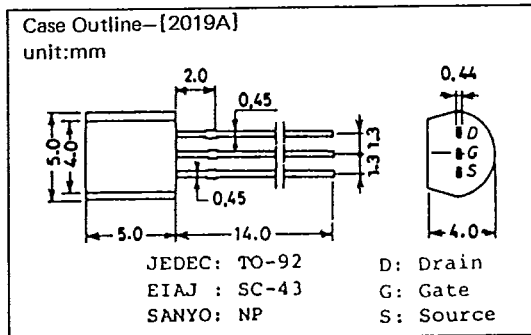
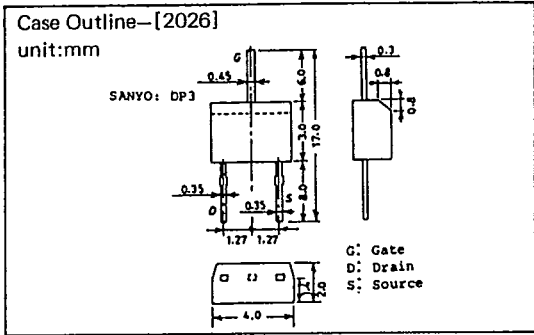
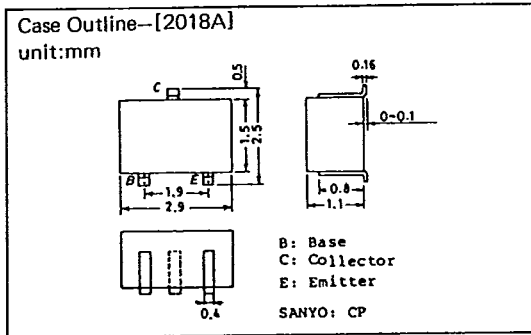
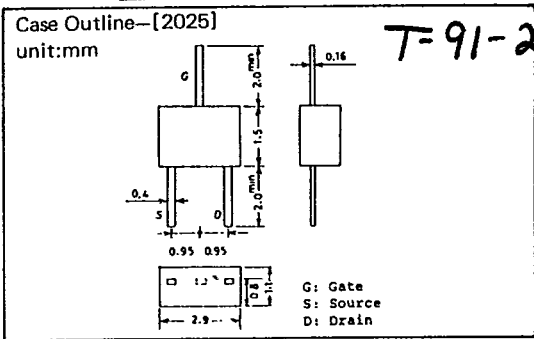
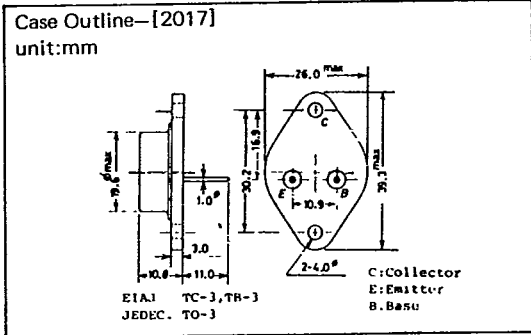

T-91-20

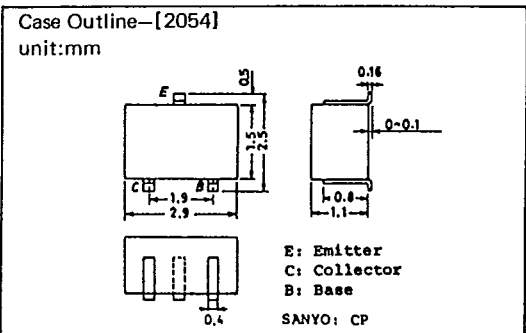
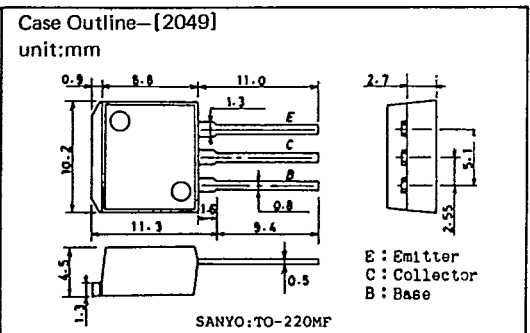
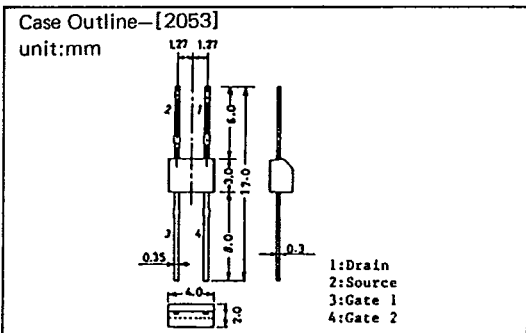
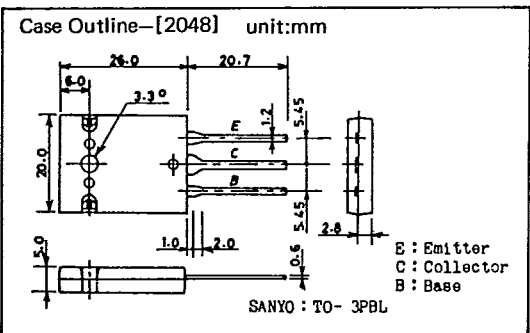
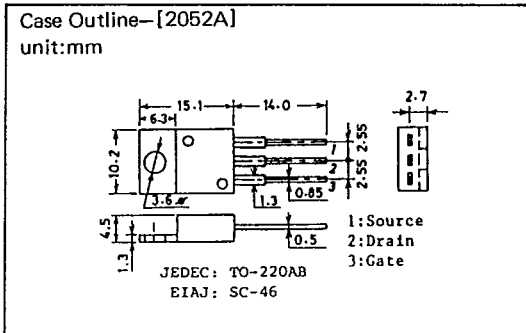
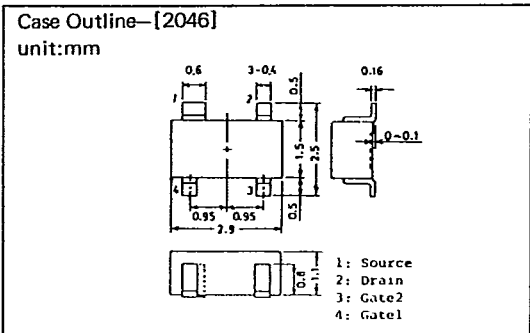
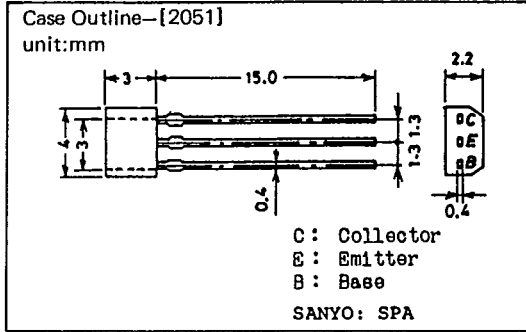
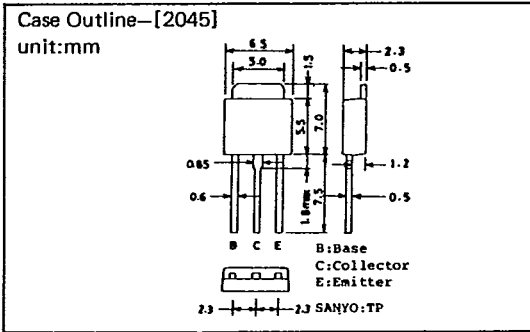
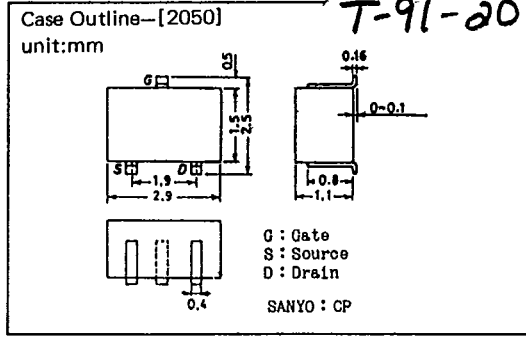
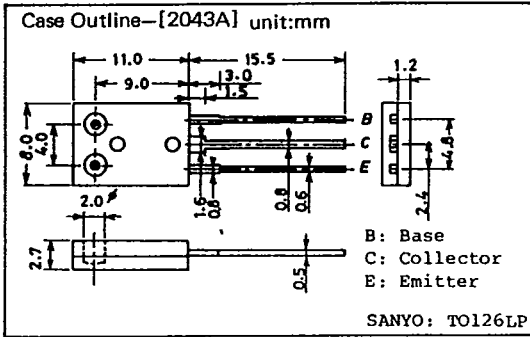

T-91-20

