

Silicon Schottky Diodes

Preliminary data

- For low-loss, fast-recovery, meter protection, bias isolation and clamping application
- Integrated diffused guard ring
- Low forward voltage

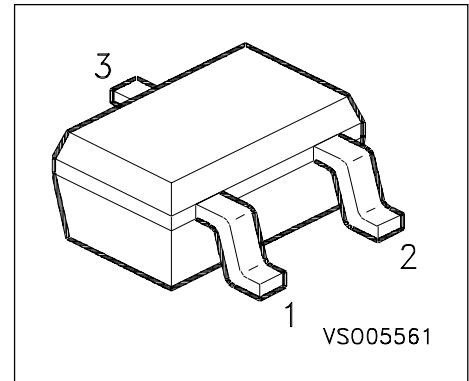

BAS 125-04W

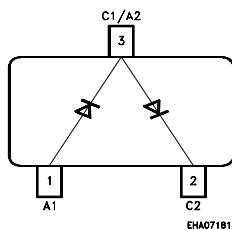

BAS 125-04W

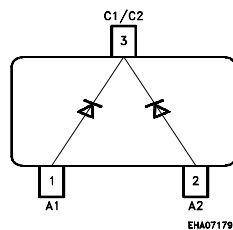

BAS 125-06W

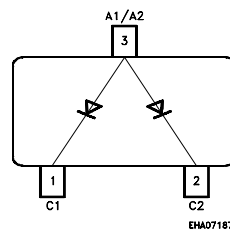

ESD: ElectroStatic Discharge sensitive device, observe handling precautions!

Type	Marking	Ordering Code	Pin Configuration			Package
BAS 125-04W	14s	Q62702-	1 = A1	2 = C2	3=C1/A2	SOT-323
BAS 125-05W	15s	Q62702-	1 = A1	2 = A2	3=C1/C2	SOT-323
BAS 125-06W	16s	Q62702-	1 = C1	2 = C2	3=A1/A2	SOT-323
BAS 125W	13s	Q62702-	1 = A		3 = C	SOT-323

Maximum Ratings

Parameter	Symbol	Values	Unit
Diode reverse voltage	V_R	25	V
Forward current	I_F	100	mA
Surge forward current ($t \leq 10\text{ms}$)	I_{FSM}	500	
Total Power dissipation $T_S \leq 25^\circ\text{C}$	P_{tot}	250	mW
Junction temperature	T_j	150	$^\circ\text{C}$
Storage temperature	T_{stg}	- 55 ... + 150	

Thermal Resistance

Junction ambient, BAS125W 1)	R_{thJA}	≤ 310	K/W
Junction ambient, BAS 125-04W...06W 1)	R_{thJA}	≤ 425	
Junction - soldering point, BAS125W	R_{thJS}	≤ 230	
Junction - soldering point, BAS125-04W...06W	R_{thJS}	≤ 265	

1) Package mounted on alumina 15mm x 16.7mm x 0.7mm

Electrical Characteristics at $T_A=25^\circ\text{C}$, unless otherwise specified

Parameter	Symbol	Values			Unit
		min.	typ.	max.	
DC characteristics					
Reverse current	I_R				nA
$V_R = 20\text{ V}$		-	-	150	
$V_R = 25\text{ V}$		-	-	200	
Forward voltage	V_F				mV
$I_F = 1\text{ mA}$		-	385	400	
$I_F = 10\text{ mA}$		-	530	650	
$I_F = 35\text{ mA}$		-	800	900	
AC Characteristics					
Diode capacitance	C_T				pF
$V_R = 0\text{ V}, f = 1\text{ MHz}$		-	-	1.1	
Differential forward resistance	R_F				Ω
$I_F = 5\text{ mA}, f = 10\text{ kHz}$		-	16	-	

Forward current $I_F = f(T_A^*; T_S)$

* Package mounted on epoxy

BAS 125W

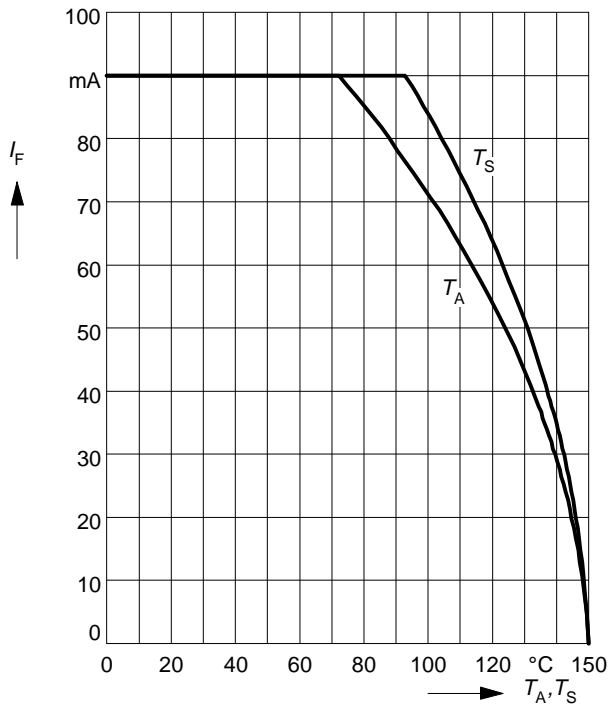

Permissible Pulse Load $R_{THJS} = f(t_p)$

BAS 125W

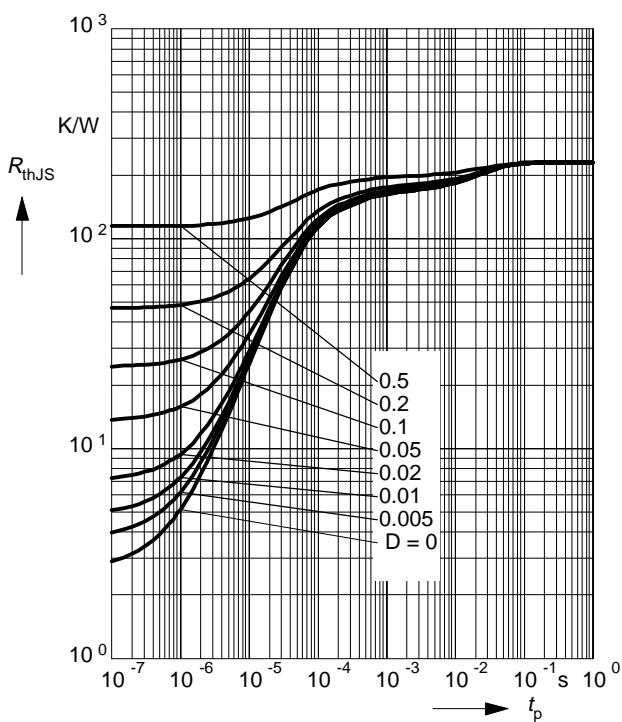

Permissible Pulse Load $I_{Fmax}/I_{FDC} = f(t_p)$

BAS 125W

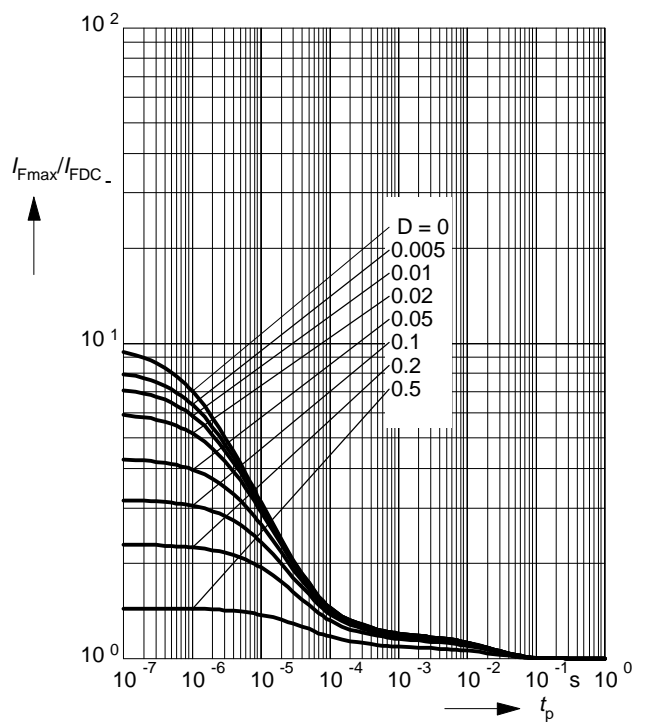

Forward current $I_F = f(T_A^*; T_S)$

* Package mounted on epoxy

BAS 125-04W... (I_F per diode)

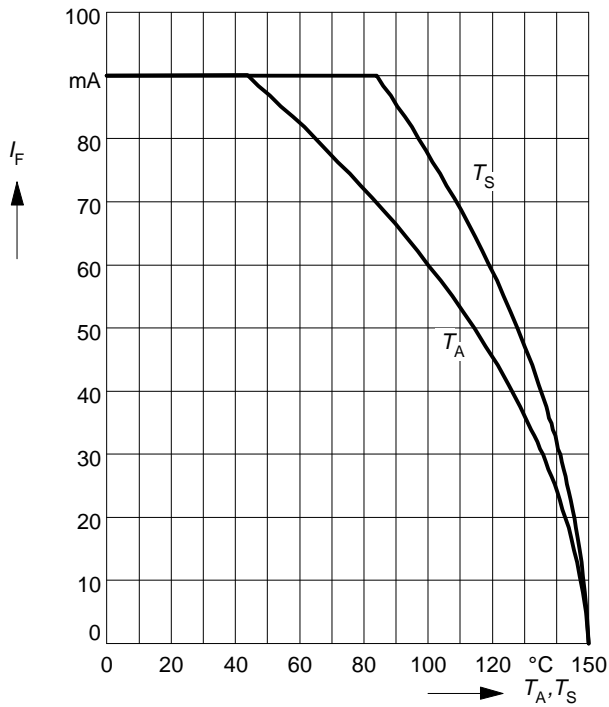

Permissible Pulse Load $R_{THJS} = f(t_p)$

BAS 125-04W...

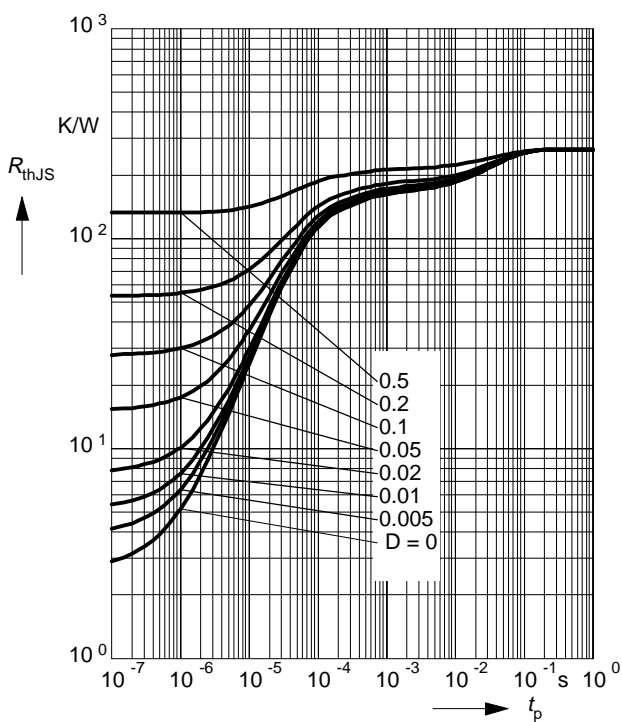

Permissible Pulse Load $I_{Fmax}/I_{FDC} = f(t_p)$

BAS 125-04W...

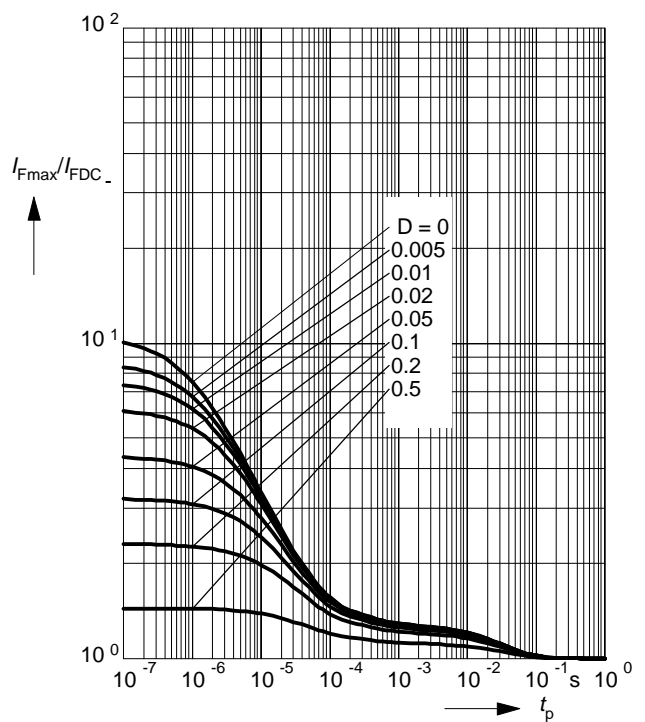

Forward Current $I_F = f(V_F)$

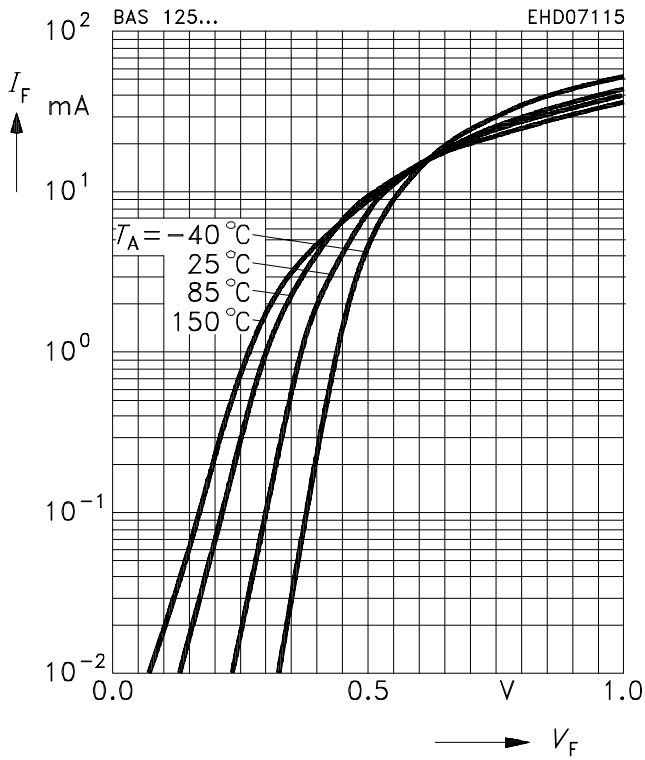

Reverse current $I_R = f(V_R)$

$T_A =$ Parameter

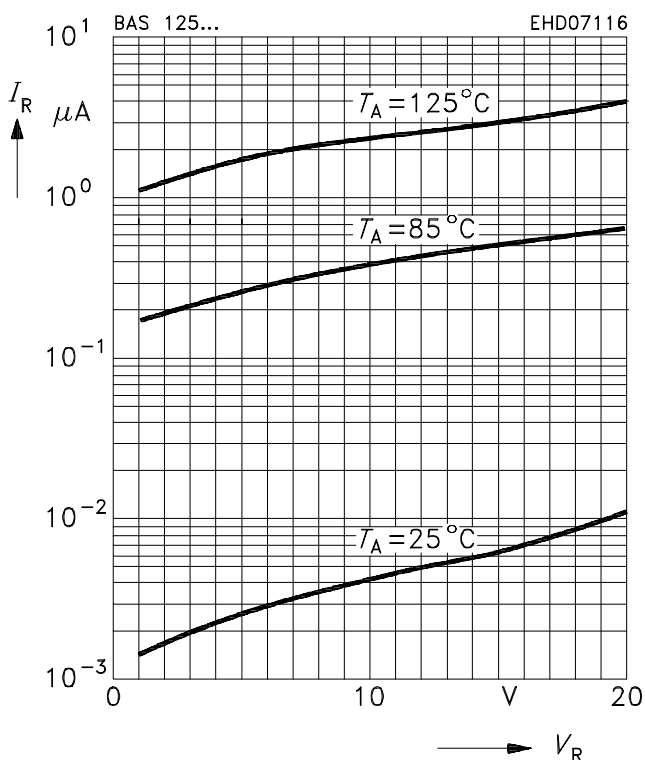

Diode capacitance $C_T = f(V_R)$

$f = 1\text{MHz}$

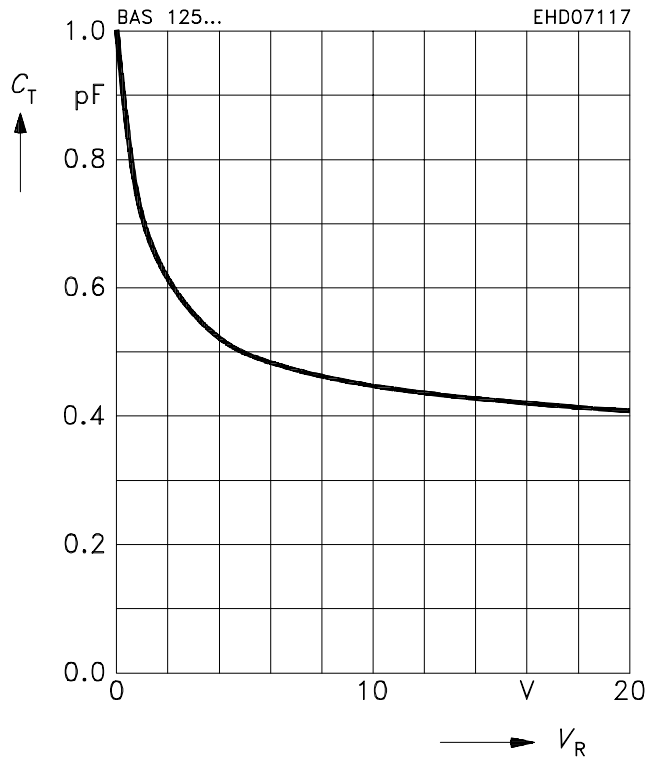

Differential forward resistance $R_F = f(I_F)$

$f = 10\text{kHz}$

