

SCHOTTKY RECTIFIER

6 Amp

$$I_{F(AV)} = 6\text{Amp}$$

$$V_R = 35 \text{ to } 45\text{V}$$

Major Ratings and Characteristics



Characteristics	6TQ	Units
$I_{F(AV)}$ Rectangular waveform	6	A
$V_{RRM}$ range	35 to 45	V
$I_{FSM}$ @tp=5µs sine	690	A
$V_F$ @6Apk, $T_J = 125^\circ\text{C}$	0.53	V
$T_J$ range	-55 to 175	$^\circ\text{C}$

Description/Features

The 6TQ Schottky rectifier series has been optimized for low reverse leakage at high temperature. The proprietary barrier technology allows for reliable operation up to 175° C junction temperature. Typical applications are in switching power supplies, converters, free-wheeling diodes, and reverse battery protection.

- 175° C  $T_J$  operation
- High purity, high temperature epoxy encapsulation for enhanced mechanical strength and moisture resistance
- Low forward voltage drop
- High frequency operation
- Guard ring for enhanced ruggedness and long term reliability

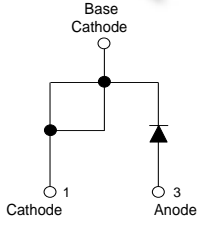
Case Styles

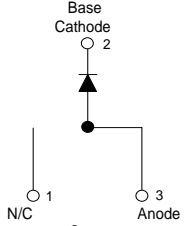
6TQ...	6TQ... S
  <p>TO-220</p>	  <p>D<sup>2</sup>PAK</p>

## 6TQ... Series

Bulletin PD-20283 rev. A 05/02

International  
**IR** Rectifier

### Voltage Ratings

Part number	6TQ035	6TQ040	6TQ045
$V_R$ Max. DC Reverse Voltage (V)	35	40	45
$V_{RWM}$ Max. Working Peak Reverse Voltage (V)			

### Absolute Maximum Ratings

Parameters	6TQ	Units	Conditions
$I_{F(AV)}$ Max. Average Forward Current * See Fig. 5	6	A	50% duty cycle @ $T_C = 164^\circ\text{C}$ , rectangular wave form
$I_{FSM}$ Max. Peak One Cycle Non-Repetitive Surge Current * See Fig. 7	690	A	5 $\mu\text{s}$ Sine or 3 $\mu\text{s}$ Rect. pulse
	140		10ms Sine or 6ms Rect. pulse
$E_{AS}$ Non-Repetitive Avalanche Energy	8	mJ	$T_J = 25^\circ\text{C}$ , $I_{AS} = 1.20\text{Amps}$ , $L = 11.10\text{mH}$
$I_{AR}$ Repetitive Avalanche Current	1.20	A	Current decaying linearly to zero in 1 $\mu\text{sec}$ Frequency limited by $T_J$ max. $V_A = 1.5 \times V_R$ typical

### Electrical Specifications

Parameters	6TQ	Units	Conditions
$V_{FM}$ Max. Forward Voltage Drop (1) * See Fig. 1	0.60	V	@ 6A
	0.73	V	@ 12A
	0.53	V	@ 6A
	0.64	V	@ 12A
$I_{RM}$ Max. Reverse Leakage Current (1) * See Fig. 2	0.8	mA	$T_J = 25^\circ\text{C}$
	7	mA	$T_J = 125^\circ\text{C}$
$V_{F(TO)}$ Threshold Voltage	0.35	V	$T_J = T_J$ max.
$r_f$ Forward Slope Resistance	18.23	m $\Omega$	
$C_T$ Max. Junction Capacitance	400	pF	$V_R = 5V_{DC}$ , (test signal range 100Khz to 1Mhz) $25^\circ\text{C}$
$L_S$ Typical Series Inductance	8.0	nH	Measured lead to lead 5mm from package body
dv/dt Max. Voltage Rate of Change	10000	V/ $\mu\text{s}$	(Rated $V_R$ )

(1) Pulse Width < 300 $\mu\text{s}$ , Duty Cycle < 2%

### Thermal-Mechanical Specifications

Parameters	6TQ	Units	Conditions
$T_J$ Max. Junction Temperature Range	-55 to 175	$^\circ\text{C}$	
$T_{stg}$ Max. Storage Temperature Range	-55 to 175	$^\circ\text{C}$	
$R_{thJC}$ Max. Thermal Resistance Junction to Case	2.2	$^\circ\text{C/W}$	DC operation * See Fig. 4
$R_{thCS}$ Typical Thermal Resistance, Case to Heatsink	0.50	$^\circ\text{C/W}$	Mounting surface, smooth and greased
wt Approximate Weight	2(0.07)	g(oz.)	
T Mounting Torque	Min.	6(5)	Kg-cm (lbf-in)
	Max.	12(10)	

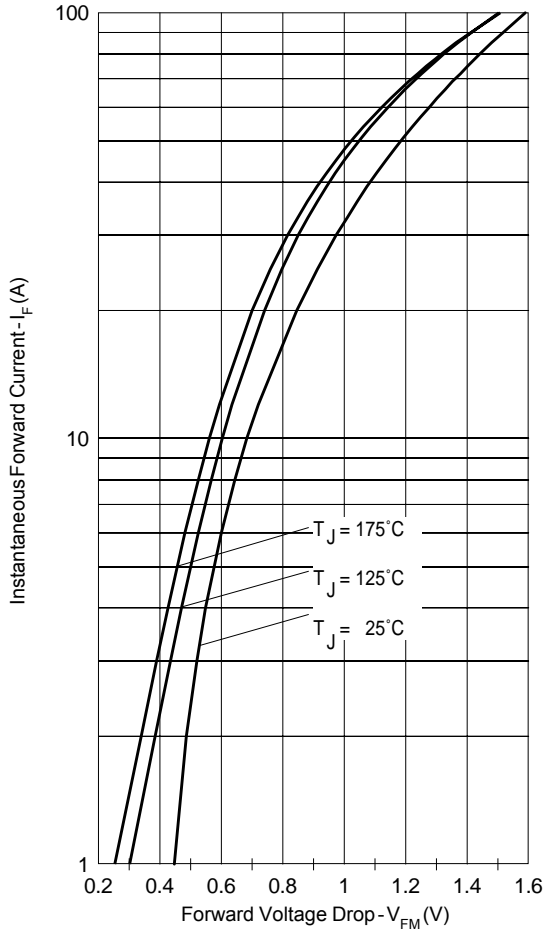

Fig. 1 - Maximum Forward Voltage Drop Characteristics

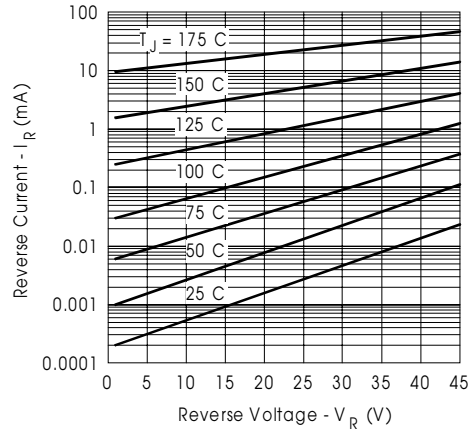

Fig. 2 - Typical Values of Reverse Current Vs. Reverse Voltage

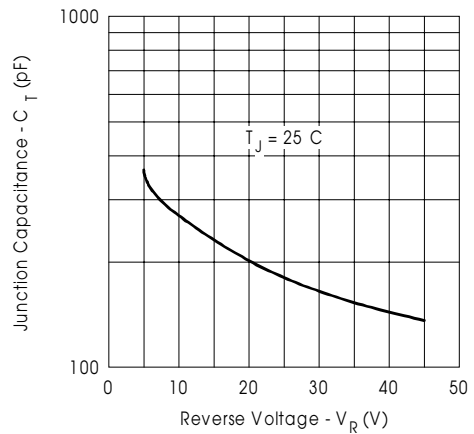

Fig. 3 - Typical Junction Capacitance Vs. Reverse Voltage

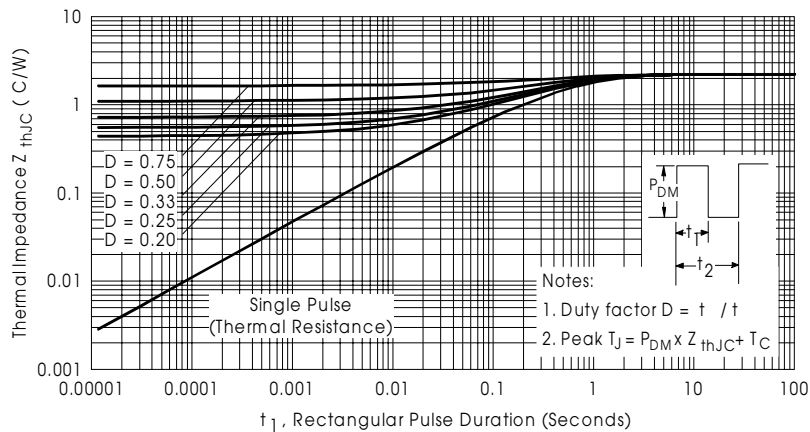

Fig. 4 - Maximum Thermal Impedance  $Z_{thJC}$  Characteristics

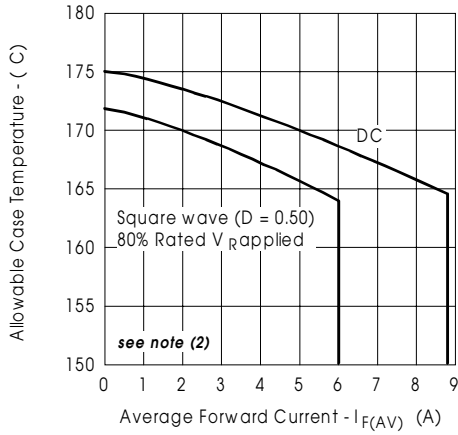

Fig. 5 - Maximum Allowable Case Temperature Vs. Average Forward Current

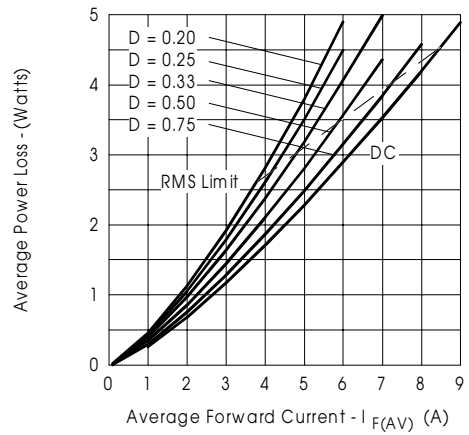

Fig. 6 - Forward Power Loss Characteristics

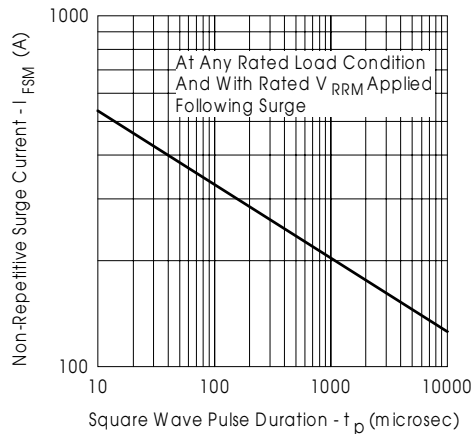

Fig. 7 - Maximum Non-Repetitive Surge Current

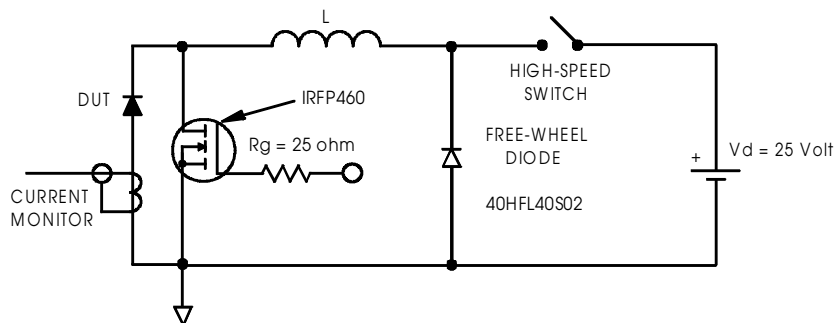

Fig. 8 - Unclamped Inductive Test Circuit

(2) Formula used:  $T_C = T_J - (Pd + Pd_{REV}) \times R_{thJC}$ ;

$Pd = \text{Forward Power Loss} = I_{F(AV)} \times V_{FM} @ (I_{F(AV)} / D)$  (see Fig. 6);

$Pd_{REV} = \text{Inverse Power Loss} = V_{R1} \times I_{R1} (1 - D)$ ;  $I_{R1} @ V_{R1} = 80\% \text{ rated } V_R$

Outline Table

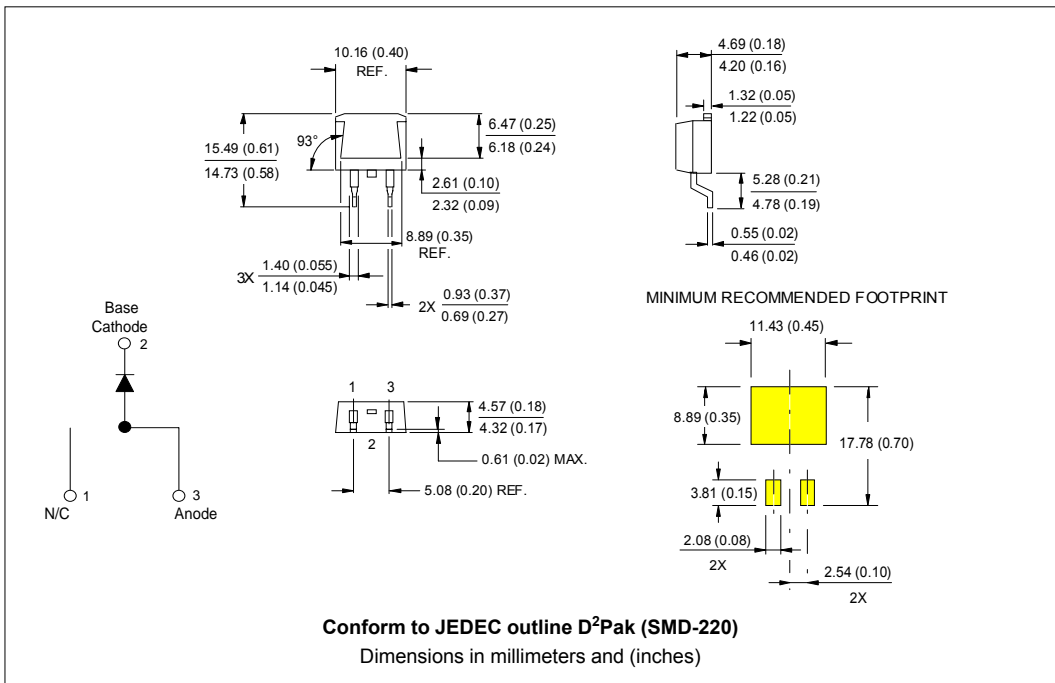
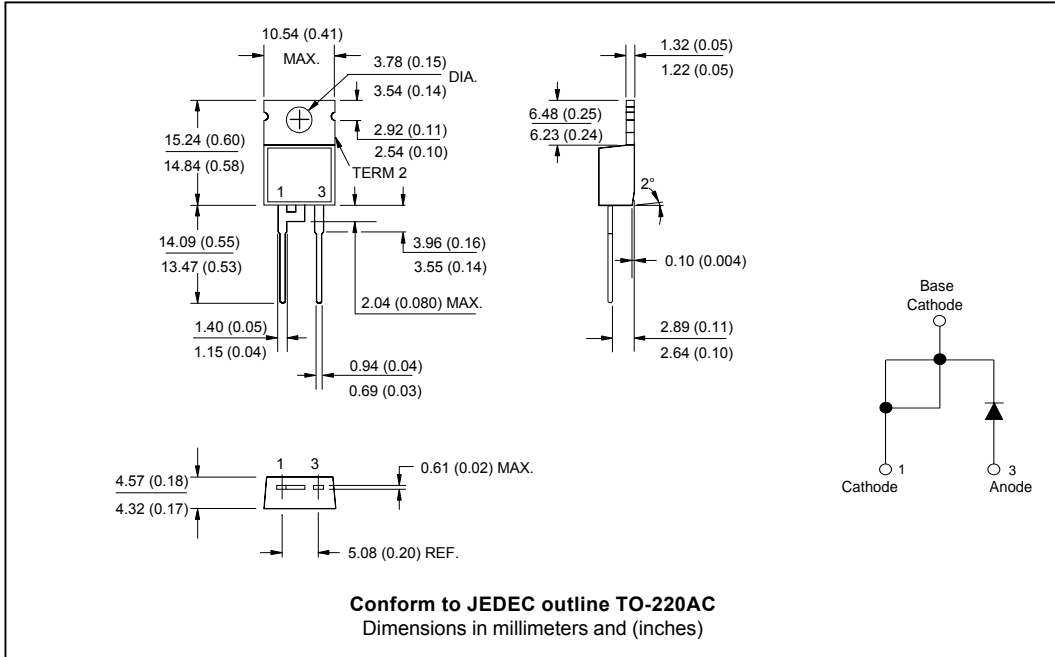

Ordering Information Table

Device Code

6	T	Q	045	S
①	②	③	④	⑤

**1** - Essential Part Number  
**2** - T = TO-220  
**3** - Q = Schottky Q Series  
**4** - Voltage Rating  
**5** - S = D<sup>2</sup>Pak

035 = 35V
040 = 40V
045 = 45V

Data and specifications subject to change without notice.  
This product has been designed and qualified for Industrial Level.  
Qualification Standards can be found on IR's Web site.