

General Description

The AAT1152 SwitchReg™ is a member of AnalogicTech™'s Total Power Management™ IC product family. The Step-down switching converter is ideal for applications where high efficiency, small size, and low ripple are critical. Able to deliver 1A with internal Power MOSFETs, the current-mode controlled IC provides high efficiency using synchronous rectification. Fully internally compensated, the AAT1152 simplifies system design and lowers external part count.

The AAT1152 features a Power Good (POK) function which monitors the output, alerting the system if the output voltage falls out of regulation.

The AAT1152 is available in MSOP-8 package, rated over -40 to 85°C.

Features

- 5.5V max supply input
- Fixed output voltage: 1.1V–4.2V with 100 mV increment
- 1A output current
- Integrated low on resistance power switches
- Synchronous rectification
- Up to 95% efficiency
- Power Good signal
- Internally compensated current mode control
- High initial accuracy: $\pm 1\%$
- 850kHz switching frequency
- Constant PWM mode
- Low output ripple with light load
- Internal softstart
- Current limit protection
- Over-Temperature protection
- MSOP-8 package

Applications

- Computer Peripherals
- Set Top Boxes
- Network Cards
- Cable/DSL Modems
- High efficiency conversion from 5V or 3.3V supply

Typical Application

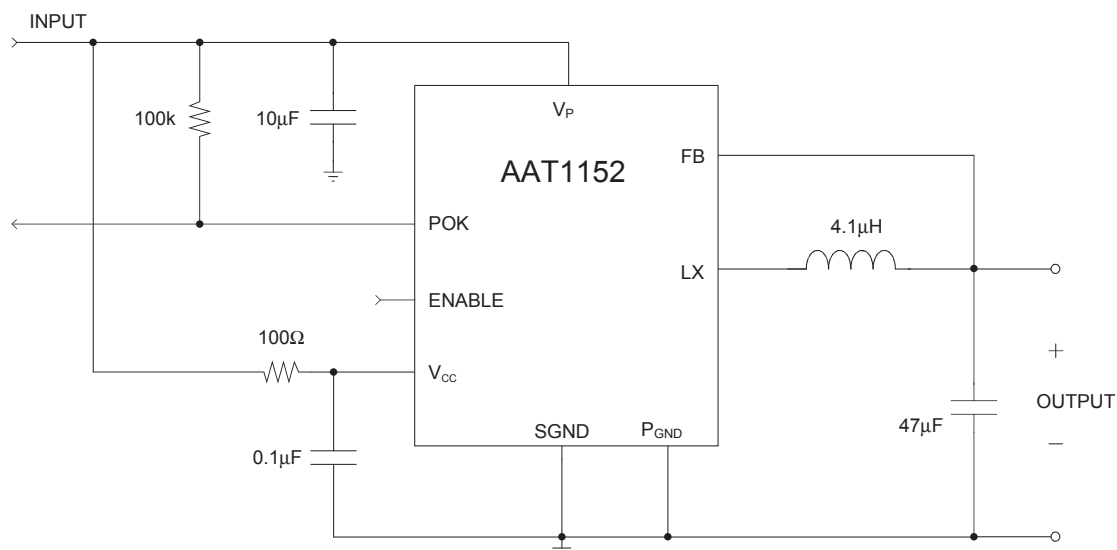

Pin Descriptions

Pin #	Symbol	Function
1	FB	Feedback input pin
2	SGND	Signal Ground
3	EN	Converter enable pin
4	V _{CC}	Small Signal Filtered Bias Supply
5	V _P	Input supply for converter power stage
6	LX	Inductor connection pin
7	POK	Power Good indicator. Open-drain output is low when V _{OUT} falls out of regulation.
8	PGND	Power ground return for output stage

Pin Configuration

MSOP-8

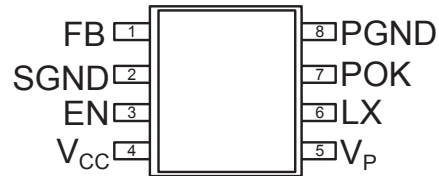

Absolute Maximum Ratings (T_A=25°C unless otherwise noted)

Symbol	Description	Value	Units
V _{CC} , V _P	V _{CC} , V _P to GND	6	V
V _{LX}	LX to GND	-0.3 to V _P +0.3	V
V _{FB}	FB to GND	-0.3 to V _{CC} +0.3	V
V _{EN} , V _{POK}	POK, EN to GND	-0.3 to 6	V
T _J	Operating Junction Temperature Range	-40 to 150	°C
T _{LEAD}	Maximum Soldering Temperature (at leads, 10 sec)	300	°C
V _{ESD}	ESD Rating ¹ - HBM	3000	V

Note: Stresses above those listed in Absolute Maximum Ratings may cause permanent damage to the device. Functional operation at conditions other than the operating conditions specified is not implied. Only one Absolute Maximum rating should be applied at any one time.

Note 1: Human body model is a 100pF capacitor discharged through a 1.5K resistor into each pin.

Thermal Characteristics

Symbol	Description	Value	Units
Θ _{JA}	Maximum Thermal Resistance (MSOP-8) ²	150	°C/W
P _D	Maximum Power Dissipation (MSOP-8) ²	833	mW

Note 2: Mounted on a demo board.

Recommended Operating Conditions

Symbol	Description	Rating	Units
T	Ambient Temperature Range	-40 to +85	°C

Electrical Characteristics ($V_{IN} = V_{CC} = V_P = 5V$, $T_A = -40$ to $85^\circ C$ unless otherwise noted. Typical values are at $T_A = 25^\circ C$)

Symbol	Description	Conditions	Min	Typ	Max	Units
V_{IN}	Operation Voltage		2.7		5.5	V
V_{OUT}	DC Output Voltage Tolerance	$I_{OUT} = 500mA$				%
		$T_A = 25^\circ C$	-1.0		+1.0	
		Full temp	-2.0		+2.0	
I_{LIM}	Current Limit	$T_A = 25^\circ C$	1.2			A
I_Q	Quiescent Supply Current	No load, $V_{FB} = 0$		160	300	μA
$\Delta V_{OUT} (V_{OUT} * \Delta V_{IN})$	Load Regulation	$V_{IN} = 4.2V$, $I_{LOAD} = 0$ to $1A$		3		%
$\Delta V_{OUT}/V_{OUT}$	Line Regulation	$V_{IN} = 2.7$ to $5.5V$		0.2		%/V
F_{OSC}	Oscillator frequency	$T_A = 25^\circ C$	700	850	1000	kHz
$R_{DSON(H)}$	High-side Switch On-resistance	$T_A = 25^\circ C$		110	150	m Ω
$R_{DSON(L)}$	Low-side Switch On-resistance	$T_A = 25^\circ C$		100	150	m Ω
$V_{EN(H)}$	Enable input high voltage	$V_{IN} = 2.7$ to $5.5V$	1.4			V
$V_{EN(L)}$	Enable input low voltage	$V_{IN} = 2.7$ to $5.5V$			0.6	V
I_{EN}	Enable Pin Leakage Current	$V_{EN} = 5.5V$			1	μA
V_{UVLO}	Undervoltage Lockout	V_{IN} rising			2.5	V
		V_{IN} falling	1.2			
$V_{UVLO(hys)}$	Undervoltage Lockout Hysteresis			250		mV
T_{SD}	Over Temp Shutdown Threshold			140		$^\circ C$
T_{HYS}	Over Temp Shutdown Hysteresis			15		$^\circ C$
I_{SHDN}	Shutdown current	$V_{EN} = 0$, $V_{IN} = 5.5V$			1	μA
$V_{TH(POK)}$	Power Good Threshold	V_{FB} Ramping Up		90		% of V_{FB}
		V_{FB} Ramping Down		88		
R_{POK}	Power Good Pull-Down On-Resistance			4		Ω

Typical Characteristics

High Side $R_{DS(ON)}$ vs. Temperature

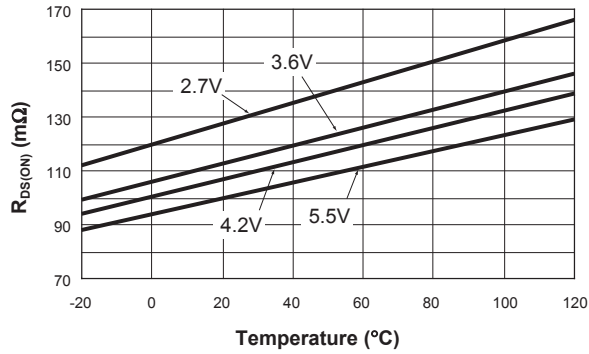

Low Side $R_{DS(ON)}$ vs. Temperature

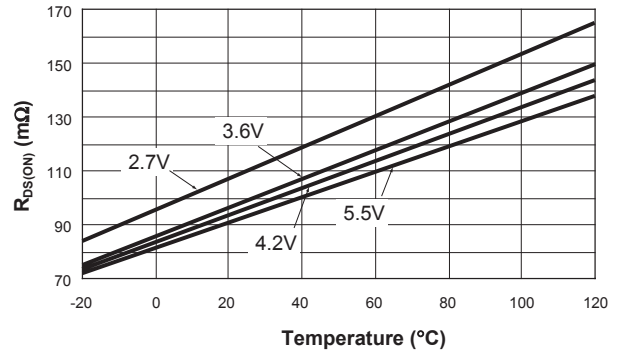

$R_{DS(ON)}$ vs. Input Voltage

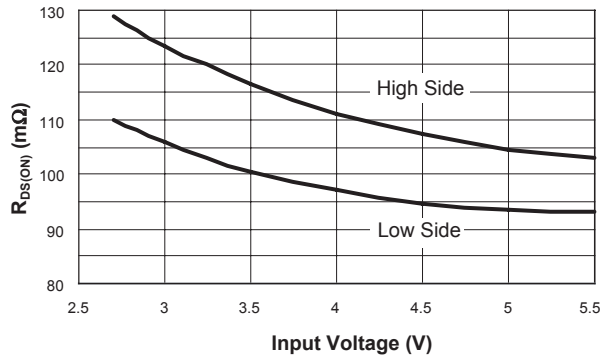

Enable Threshold vs. Input Voltage

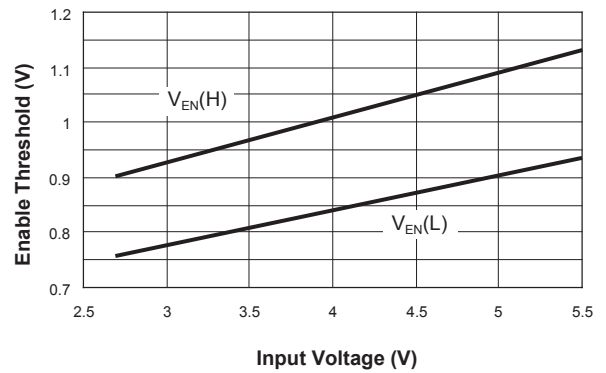

Oscillator Frequency Variation vs. Supply Voltage

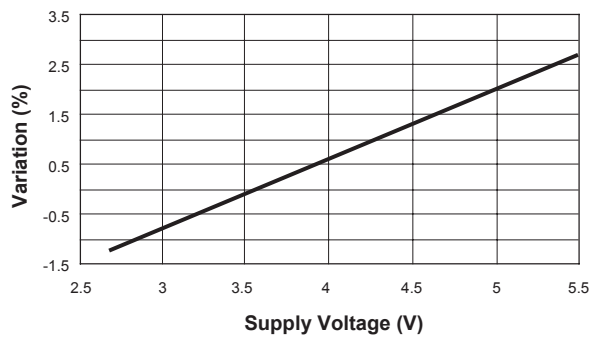

Oscillator Frequency Variation vs. Temperature
 $V_{IN}=3.6V$

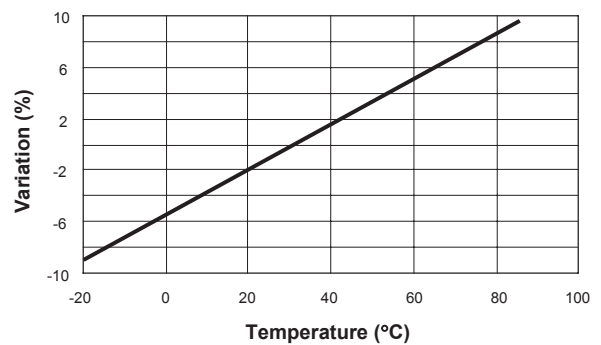

Typical Characteristics

Output Voltage vs. Temperature

$I_{OUT}=900mA, V_{OUT}=1.5V$

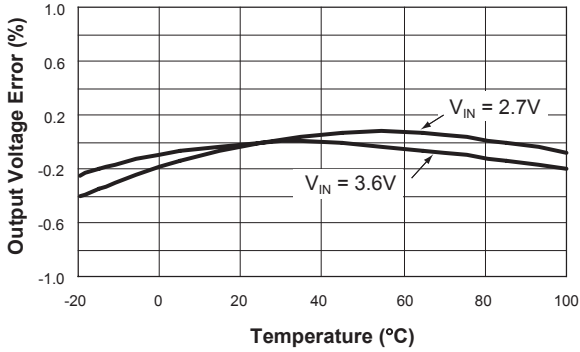

Line Regulation

$V_{OUT}=1.5V$

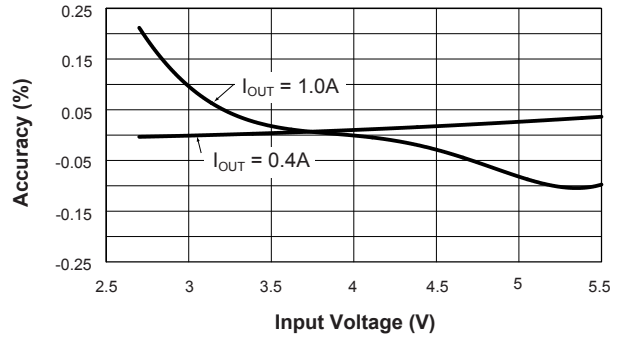

Load Regulation

$V_{OUT}= 1.5V, V_{IN}=3.6V$

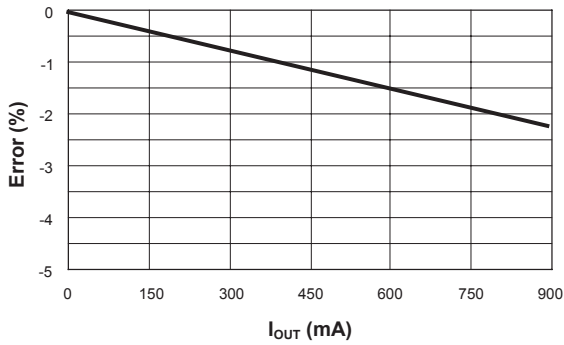

Load Regulation

$V_{OUT}=3.3V, V_{IN}=5.0V$

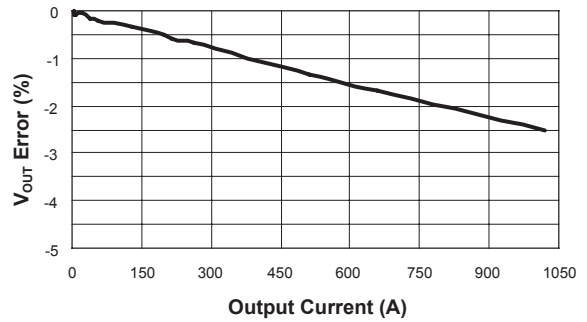

Efficiency vs. Input Voltage

$V_{OUT}=1.5V$

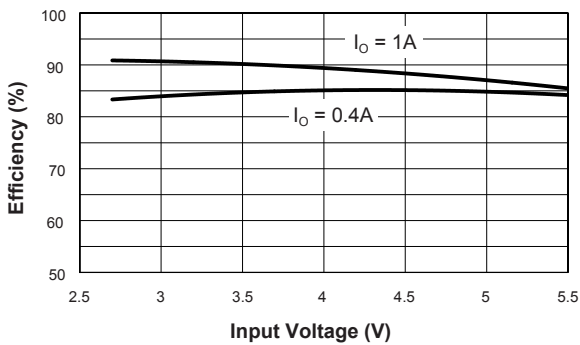

Loop Gain and Phase vs. Output Capacitor

$V_{IN} = 3.6V I_{OUT} = 0.3A$

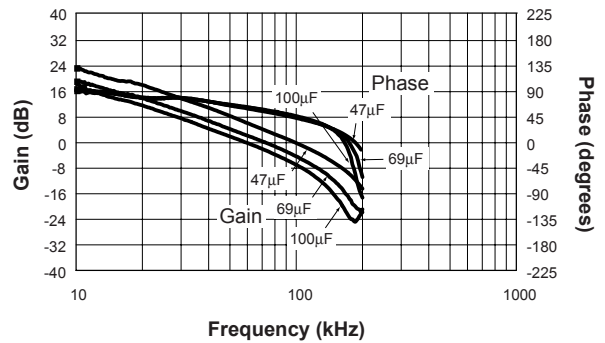

Typical Characteristics

No Load Input Current vs. Temperature

$$V_{CC} = V_P$$

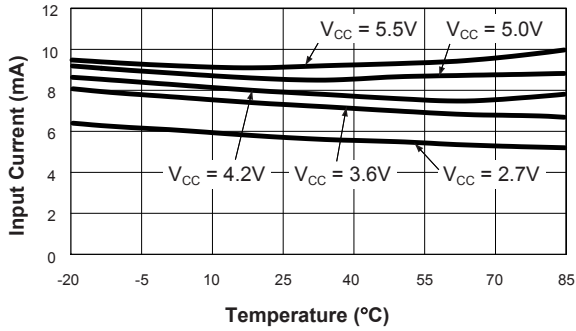

Non-Switching I_Q vs. Temperature

$$FB = 0V, V_P = V_{CC}$$

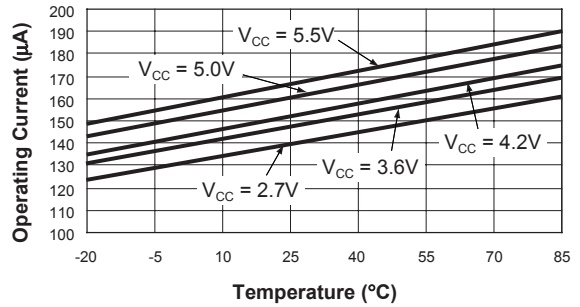

Switching Waveform

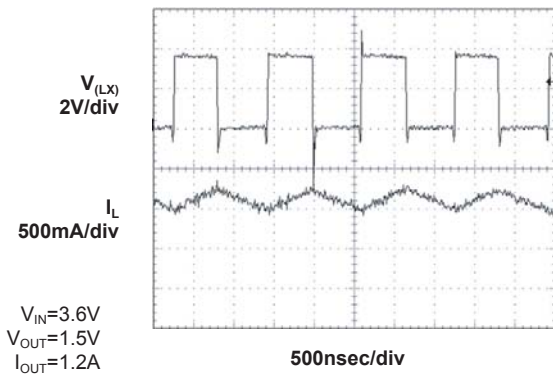

Transient Response

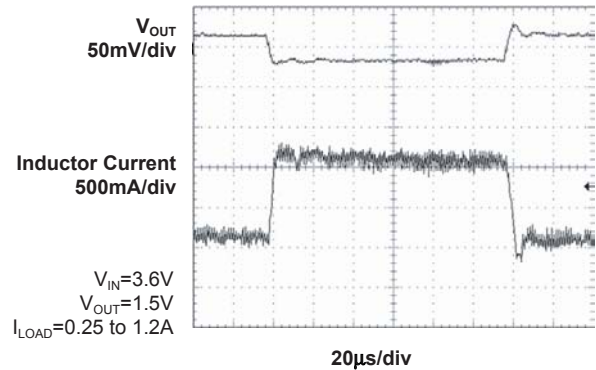

Output Ripple
1.5V, No Load

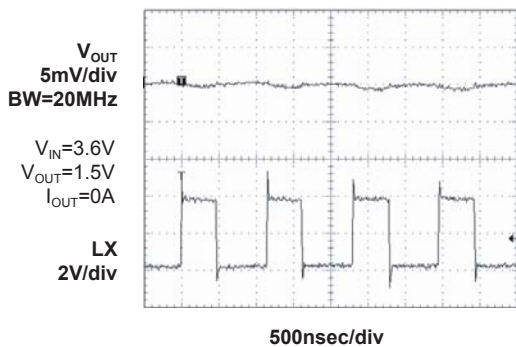

Output Ripple
1.5V, 1A Load

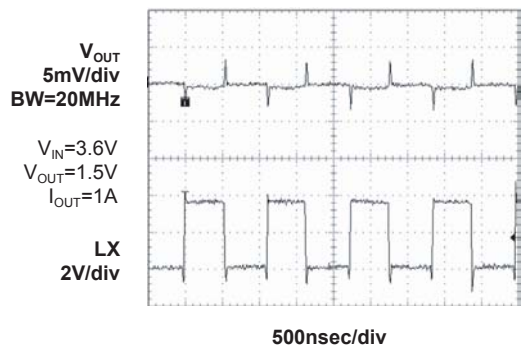

Typical Characteristics

Output Ripple
3.3V, No Load

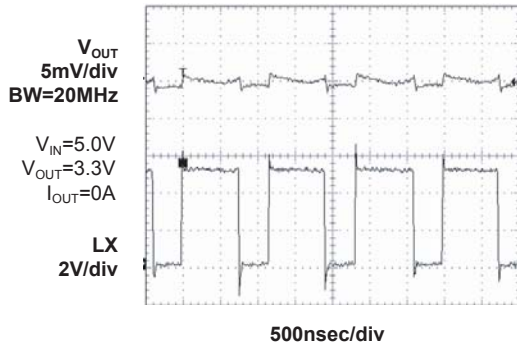

Output Ripple
3.3V, 1A Load

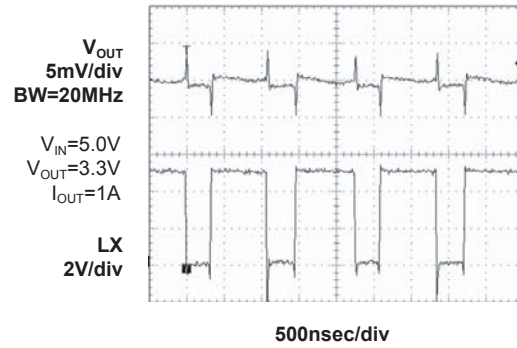

Functional Block Diagram

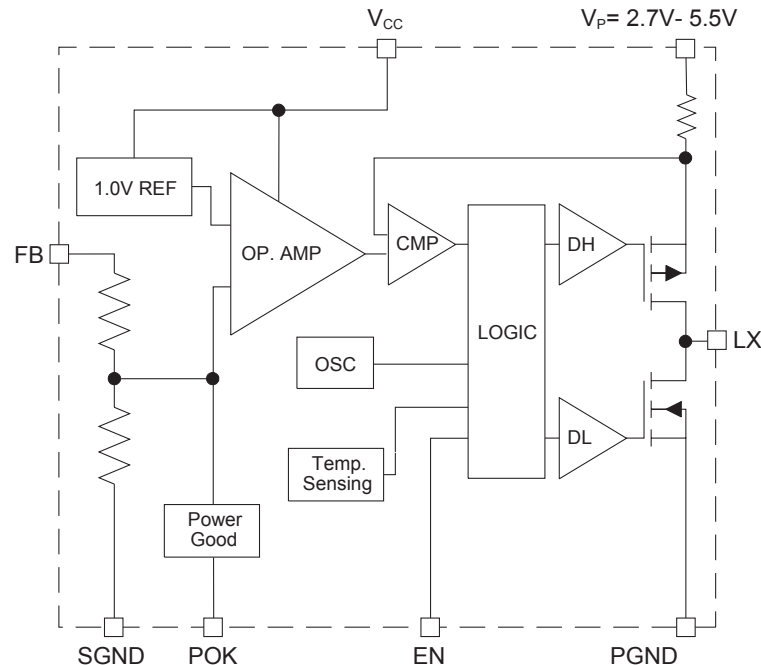

Applications Information

850 kHz 1 Amp DC-DC Synchronous Buck Converter Control Loop

The AAT1152 is a peak current mode buck converter. The inner, wide bandwidth loop controls the peak current of the output inductor. The output inductor current is sensed through the P-Channel MOSFET (high side) and is also used for short circuit and overload protection. A fixed slope compensation signal is added to the sensed current to maintain stability. The loop appears as a voltage programmed current source in parallel with the output capacitor.

The voltage error amplifier output programs the current loop for the necessary inductor current to

force a constant output voltage for all load and line conditions. The feedback resistive divider is internal, dividing the output voltage to the error amplifier reference voltage of 1.0V. The error amplifier does not have a large DC gain typical of most error amplifiers. This eliminates the need for external compensation components while still providing sufficient DC loop gain for load regulation. The crossover frequency and phase margin are set by the output capacitor value only.

Soft-Start/Enable

Soft start increases the inductor current limit point in discrete steps when the input voltage or enable input is applied. It limits the current surge seen at the input and eliminates output voltage overshoot. The enable input, when pulled low, forces the AAT1152 into a low power non-switching state. The total input current during shutdown is less than 1µA.

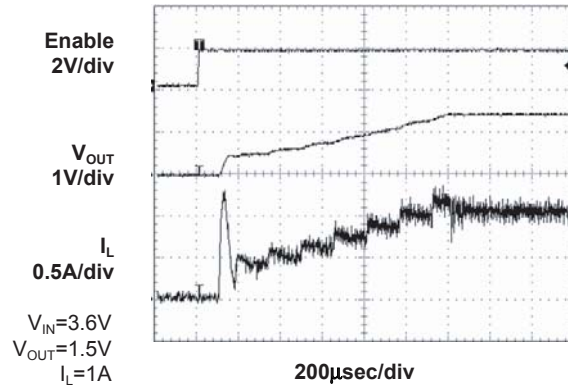

Figure 1: Inrush Limit

Power and Signal Source

Separate small signal ground and power supply pins isolate the internal control circuitry from the noise associated with the output MOSFET switching. The low pass filter R1 and C3 in schematic figures 3 and 4 filters the noise associated with the power switching.

Current Limit and Over-temperature protection

For overload conditions the peak input current is limited. Figure 2 displays the VI current limit characteristics. As load impedance decreases and the output voltage falls closer to zero, more power is dissipated internally, raising the device temperature. Thermal protection completely disables switching when internal dissipation becomes excessive, protecting the device from damage. The junction over-temperature threshold is 140°C with 15°C of hysteresis.

Current Limit Characteristic

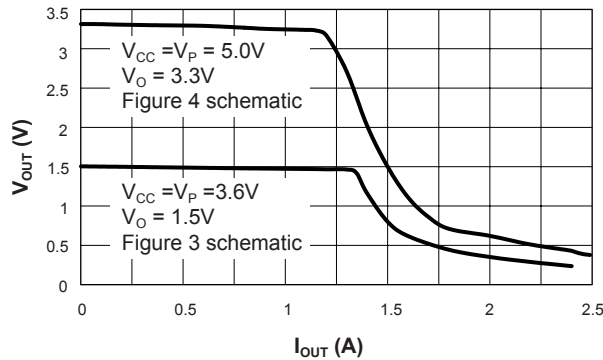

Figure 2.

Power Good

The AAT 1152 features an integrated Power Good (POK) comparator and open-drain output signal. The POK pin goes low when the converter's output is 12% or more below its nominal regulation voltage or when the device is in shutdown. Connect a pull-up resistor from POK to the converter's input or output. Typical resistor pull-up values range from 100k to 10k.

Inductor

The output inductor is selected to limit the ripple current to some predetermined value, typically 20-40% of the full load current at the maximum input voltage. Manufacturer's specifications list both the inductor DC current rating, which is a thermal limitation, and the peak current rating, which is determined by the saturation characteristics. The inductor should not show any appreciable saturation under all normal load conditions. During over load and short circuit conditions, the average current in the inductor can meet or exceed the I_{LIMIT} point of the AAT1152 without effecting the converter performance. Some inductors may have sufficient peak and average current ratings yet result in excessive losses due to a high DCR. Always consider the losses associated with the DCR and its effect on the total converter efficiency when selecting an inductor.

For a 1 Amp load and the ripple set to 30% at the maximum input voltage, the maximum peak to peak ripple current is 300 mA. The inductance value required is 3.9 μ H.

$$L = \frac{V_{OUT}}{I_O \cdot k \cdot F} \cdot \left(1 - \frac{V_{OUT}}{V_{IN}}\right)$$

$$L = \frac{1.5V}{1.0A \cdot 0.3 \cdot 830kHz} \cdot \left(1 - \frac{1.5V}{4.2V}\right)$$

$$L = 3.9\mu H$$

The factor "k" is the fraction of full load selected for the ripple current at the maximum input voltage. The corresponding inductor rms current is:

$$I_{RMS} = \sqrt{I_O^2 + \frac{\Delta I^2}{12}} \approx I_O = 1.0A$$

ΔI is the peak to peak ripple current which is fixed by the inductor selection above. For a peak to peak current of 30% of the full load current the peak current at full load will be 115% of the full load. The 4.1 μ H inductor selected from the Sumida CDRH5D18 series has a 57 m Ω DCR and a 1.95 Amp DC current rating. At full load the inductor DC loss is 57mW which amounts to a 3.8% loss in efficiency.

Input Capacitor

The primary function of the input capacitor is to provide a low impedance loop for the edges of pulsed current drawn by the AAT1152. A low ESR/ESL ceramic capacitor is ideal for this function. To minimize the stray inductance the capacitor should be placed as close as possible to the IC. This keeps the high frequency content of the input current localized, minimizing radiated and conducted EMI while facilitating optimum performance of the AAT1152. Ceramic X5R or X7R capacitors are ideal for this function. The size required will vary depending on the load, output voltage and input voltage source impedance characteristics. A typical value is around 10 μ F. The input capacitor RMS current varies with the input voltage and the output voltage. The equation for the maximum RMS current in the input capacitor is:

$$I_{RMS} = I_O \cdot \sqrt{\frac{V_O}{V_{IN}} \cdot \left(1 - \frac{V_O}{V_{IN}}\right)}$$

The input capacitor RMS ripple current reaches a maximum when V_{IN} is two times the output voltage where it is approximately one half of the load current. Losses associated with the input ceramic capacitor are typically minimal and not an issue. The proper placement of the input capacitor can be seen in the reference design layout in figures 5 and 6.

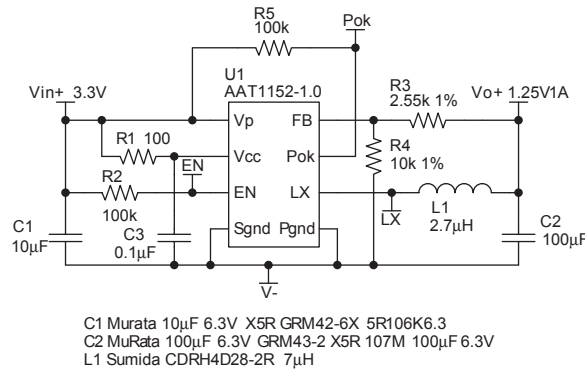

Figure 3: 3.3V to 1.25V converter

Output Capacitor

Since there are no external compensation components, the output capacitor has a strong effect on loop stability. Larger output capacitance will reduce the crossover frequency with greater phase margin. For the 1.5V 1A design using the 4.1 µH inductor, a 47µF capacitor provides a stable loop with 35 degrees of phase margin at a crossover frequency of 100 kHz. Doubling the capacitance to 100µF reduces the crossover frequency to half while increasing the phase margin to 60 degrees. In addition to assisting stability, the output capacitor limits the output ripple and provides holdup during large load transitions. A 100µF X5R or X7R ceramic capacitor provides sufficient bulk capacitance to

stabilize the output during large load transitions and has ESR and ESL characteristics necessary for low output ripple. The output capacitor rms ripple current is given by:

$$I_{RMS} = \frac{1}{2 \cdot \sqrt{3}} \cdot \frac{(V_{OUT} + V_{FWD}) \cdot (V_{IN} - V_{OUT})}{L \cdot F \cdot V_{IN}}$$

For a ceramic capacitor the dissipation due to the RMS current of the capacitor is not a concern. Tantalum capacitors, with sufficiently low ESR to meet output voltage ripple requirements, also have an RMS current rating much greater than that actually seen in this application.

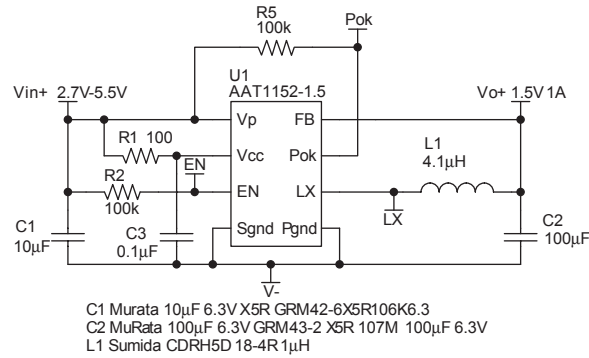

1.5V Efficiency vs. I_{OUT}

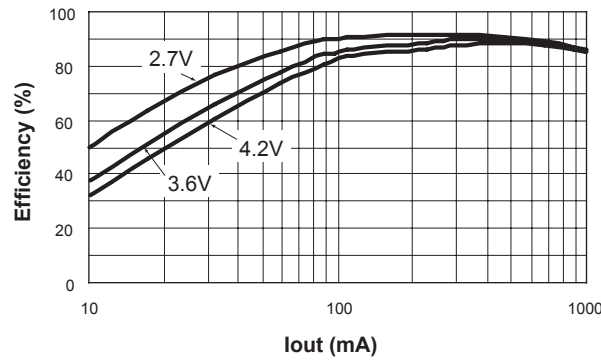

Figure 4: Lithium-Ion to 1.5V Output Converter

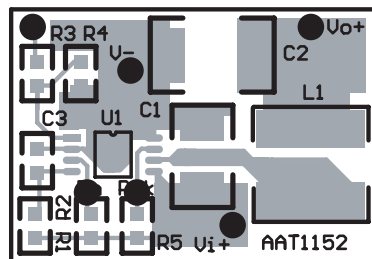

Figure 5: AAT1152 Layout Top Layer

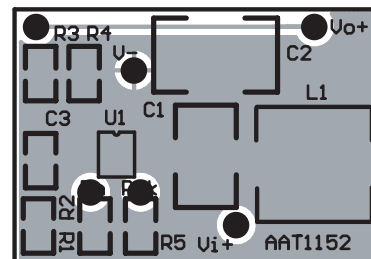

Figure 6: AAT1152 Layout Bottom Layer

Adjustable Output

For applications requiring an output other than the fixed outputs available, the 1V version can be programmed externally. Resistors R3 and R4 of figure 3 force the output to regulate higher than 1 Volt. R4 should be 100 times less than the internal 1 MegOhm resistance of the FB pin. Once R4 is selected R3 can be calculated. For a 1.25V output with R4 set to 10.0k, R3 is 2.55kΩ.

$$R3 = (V_o - 1) \cdot R4 = 0.25 \cdot 10.0k\Omega = 2.55k\Omega$$

Layout Considerations

Figures 5 and 6 display the suggested PCB layout for the AAT1152. The most critical aspect of the layout is the placement of the input capacitor C1. For proper operation C1 must be placed as close as possible to the AAT1152.

Thermal Calculations

There are two types of losses associated with the AAT1152 output switching MOSFET, switching losses and conduction losses. The conduction losses are associated with the R_{ds(on)} characteristics of the output switching device. At full load, assuming continuous conduction mode (CCM), a simplified form of the total losses is:

$$P_{LOSS} = \frac{I_o^2 \cdot (R_{DSON(H)} \cdot V_o + R_{DSON(L)} \cdot (V_{IN} - V_o))}{V_{IN}} + t_{sw} \cdot F \cdot I_o \cdot V_{IN} + I_Q \cdot V_{IN}$$

Once the total losses have been determined the junction temperature can be derived from the Θ_{JA} for the MSOP-8 package.

Design Example

Specifications

$$I_{OUT} = 1.0A$$

$$I_{RIPPLE} = 30\% \text{ of full load at max } V_{IN}$$

$$V_{OUT} = 1.5V$$

$$V_{IN} = 2.7 - 4.2 V \text{ (3.6V nominal)}$$

$$F_s = 830 \text{ kHz}$$

Maximum Input Capacitor Ripple:

$$I_{RMS} = I_o \cdot \sqrt{\frac{V_o}{V_{INMAX}} \cdot \left(1 - \frac{V_o}{V_{INMAX}}\right)} = \frac{I_o}{2} = 0.5A_{RMS}$$

$$P = ESR_{COUT} \cdot I_{RMS}^2 = 5m\Omega \cdot 0.5^2 A = 1.25mW$$

Inductor Selection:

$$L = \frac{V_{OUT}}{I_O \cdot k \cdot F} \cdot \left(1 - \frac{V_{OUT}}{V_{IN}}\right) = \frac{1.5V}{1.0A \cdot 0.3 \cdot 830kHz} \cdot \left(1 - \frac{1.5V}{4.2V}\right) = 3.9\mu H$$

Select Sumida inductor CDRH5D18 4.1μH 57mΩ 2.0 mm height.

$$\Delta I = \frac{V_O}{L \cdot F} \cdot \left(1 - \frac{V_O}{V_{IN}}\right) = \frac{1.5V}{4.1\mu H \cdot 830kHz} \cdot \left(1 - \frac{1.5V}{4.2V}\right) = 280mA$$

$$I_{PK} = I_{OUT} + \frac{\Delta I}{2} = 1.0A + 0.14A = 1.14A$$

$$P = I_O^2 \cdot DCR = 57mW$$

Output Capacitor Dissipation:

$$I_{RMS} = \frac{1}{2 \cdot \sqrt{3}} \cdot \frac{V_{OUT} \cdot (V_{IN} - V_{OUT})}{L \cdot F \cdot V_{IN}} = \frac{1}{2 \cdot \sqrt{3}} \cdot \frac{1.5V \cdot (4.2V - 1.5V)}{4.1\mu H \cdot 830kHz \cdot 4.2V} = 82mA_{RMS}$$

$$P_{ESR} = ESR_{COUT} \cdot I_{RMS}^2 = 5m\Omega \cdot .082^2 A = 33\mu W$$

AAT1152 Dissipation:

$$P = \frac{I_O^2 \cdot (R_{DSON(H)} \cdot V_O + R_{DSON(L)} \cdot (V_{IN} - V_O))}{V_{IN}} + (t_{sw} \cdot F \cdot I_O + I_Q) \cdot V_{IN}$$

$$= \frac{(0.14\Omega \cdot 1.5V + 0.145\Omega \cdot (3.6V - 1.5V))}{3.6V} + (20nsec \cdot 830kHz \cdot 1.0A + 0.3mA) \cdot 3.6V = 0.203W$$

$$T_{J(MAX)} = T_{AMB} + \Theta_{JA} \cdot P_{LOSS} = 85^\circ C + 150^\circ C/W \cdot 0.203W = 115^\circ C$$

Table 1: Surface Mount Inductors

Manufacturer	Part Number	Value	Max DC Current	DCR	Size (mm) L × W × H	Type
TaiyoYuden	NPO5DB4R7M	4.7μH	1.4A	.038	5.9 × 6.1 × 2.8	Shielded
Toko	A914BYW-3R5M-D52LC	3.5μH	1.34A	.073	5.0 × 5.0 × 2.0	Shielded
Sumida	CDRH5D28-4R2	4.2μH	2.2A	.031	5.7 × 5.7 × 3.0	Shielded
Sumida	CDRH5D18-4R1	4.1μH	1.95A	.057	5.7 × 5.7 × 2.0	Shielded
MuRata	LQH55DN4R7M03	4.7μH	2.7A	.041	5.0 × 5.0 × 4.7	Non-shielded
MuRata	LQH66SN4R7M03	4.7μH	2.2A	.025	6.3 × 6.3 × 4.7	Shielded

Table 2: Surface Mount Capacitors

Manufacturer	Part Number	Value	Voltage	Temp. Co.	Case
TDK	C4532X5ROJ107M	100μF	6.3V	X5R	1812
MuRata	GRM43-2 X5R 107M 6.3	100μF	6.3V	X5R	1812
MuRata	GRM43-2 X5R 476K 6.3	47μF	6.3V	X5R	1812
MuRata	GRM40 X5R 106K 6.3	10μF	6.3V	X5R	0805
MuRata	GRM42-6 X5R 106K 6.3	10μF	6.3V	X5R	1206

Ordering Information

Output Voltage	Package	Marking	Part Number (Tape and Reel)
1.0V	MSOP-8		AAT1152IKS-1.0-T1
1.1V	MSOP-8		AAT1152IKS-1.1-T1
1.2V	MSOP-8		AAT1152IKS-1.2-T1
1.5V	MSOP-8		AAT1152IKS-1.5-T1
1.8V	MSOP-8		AAT1152IKS-1.8-T1
2.0V	MSOP-8		AAT1152IKS-2.0-T1
2.5V	MSOP-8		AAT1152IKS-2.5-T1
3.0V	MSOP-8		AAT1152IKS-3.0-T1
3.3V	MSOP-8		AAT1152IKS-3.3-T1

Package Information

MSOP-8

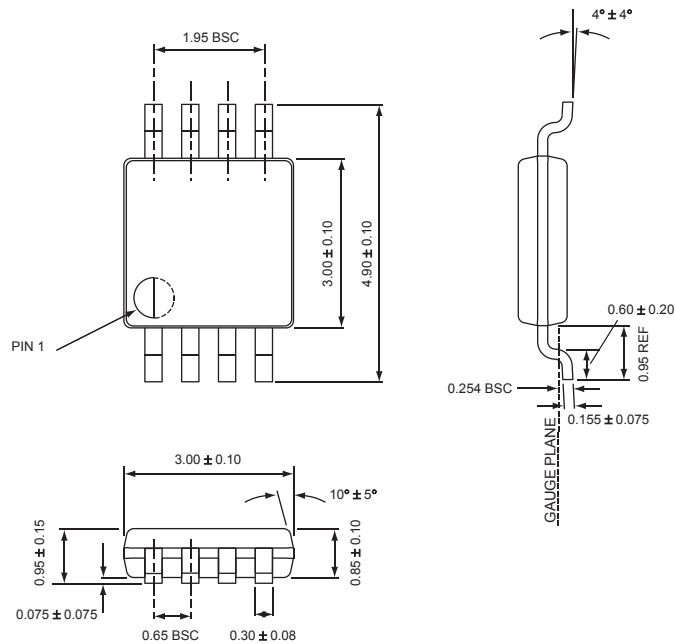

All dimensions in millimeters.

AnalogicTech cannot assume responsibility for use of any circuitry other than circuitry entirely embodied in an AnalogicTech product. No circuit patent licenses, copyrights, mask work rights, or other intellectual property rights are implied.

AnalogicTech reserves the right to make changes to their products or specifications or to discontinue any product or service without notice, and advise customers to obtain the latest version of relevant information to verify, before placing orders, that information being relied on is current and complete. All products are sold subject to the terms and conditions of sale supplied at the time of order acknowledgement, including those pertaining to warranty, patent infringement, and limitation of liability.

AnalogicTech warrants performance of its semiconductor products to the specifications applicable at the time of sale in accordance with AnalogicTech's standard warranty. Testing and other quality control techniques are utilized to the extent AnalogicTech deems necessary to support this warranty. Specific testing of all parameters of each device is not necessarily performed.

Advanced Analogic Technologies, Inc.
830 E. Arques Avenue, Sunnyvale, CA 94085
Phone (408) 737-4600
Fax (408) 737-4611