

# Z-POWER LED Series

## Technical Datasheet for X1029X

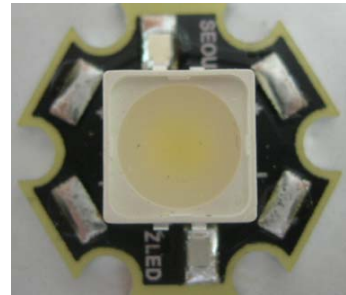

Z-Power series is designed for high current operation and high flux output applications.

Z-Power LED's thermal management perform exceeds other power LED solutions.

It incorporates state of the art SMD design and Thermal emission material.

Z Power LED is ideal light sources for general illumination applications, custom designed solutions, automotive large LCD backlights

### Features

- Super high Flux output and high Luminance
- Designed for high current operation
- Low thermal resistance
- SMT solderability
- Lead Free product
- RoHS compliant

### Applications

- General Illumination
  - Outdoor & Indoor architectural lighting
  - Decorative lighting
  - Torch lighting
  - Portable lighting (Flash and lamp) and Reading lighting
  - Traffic signaling



## Full Code of Z-Power LED Series

Full code form :  $X_1 X_2 X_3 X_4 X_5 X_6 - X_7 X_8 - X_9 X_{10} X_{11} X_{12} X_{13}$

### 1. Part Number

- $X_1$  : Color
- $X_2$  : Z-Power LED series number
- $X_3$  : LENS type
- $X_4$  : Chip quantity (or Power Dissipation)
- $X_5$  : Package outline size
- $X_6$  : Type of PCB

### 2. Internal Number

- $X_7$
- $X_8$

### 3. Code Labeling

- $X_9$  : Luminous flux (or Radiant flux for royal blue)
- $X_{10} X_{11} X_{12}$  : Dominant wavelength (or x,y coordinates rank code)
- $X_{13}$  : Forward voltage

### 4. Sticker Diagram on Reel & Aluminum Vinyl Bag

PART NO. :  $X_1 X_2 X_3 X_4 X_5 X_6 - X_7 X_8$   
[Barcode]  
QUANTITY : ###  
[Barcode]  
LOT NUMBER : #####  
[Barcode]  
BIN CODE :  $X_9 X_{10} X_{11} X_{12} X_{13}$   
[Barcode]



For more information about binning and labeling, refer to the Application Note -1



## Outline Dimensions

### 1. Dome Type

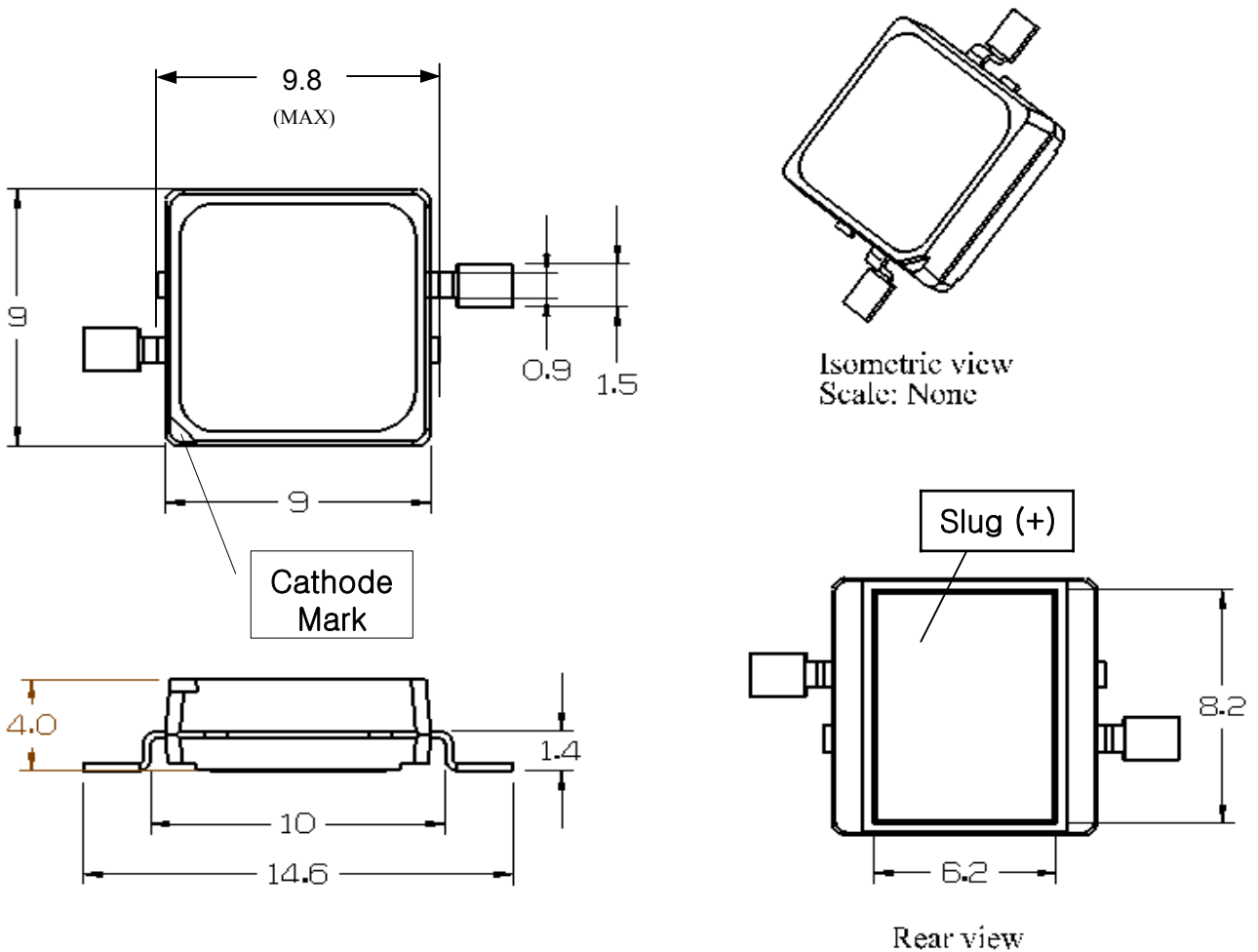

Notes :

1. All dimensions are in millimeters. (tolerance :  $\pm 0.2$  )
2. Scale : none
3. Slug of package is connected to anode.

\*The appearance and specifications of the product may be changed for improvement without notice.

## PCB Type Outline Dimensions

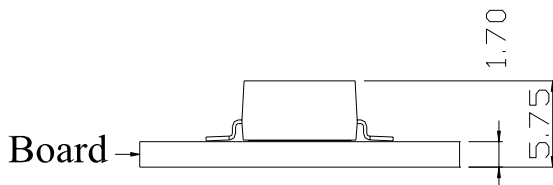
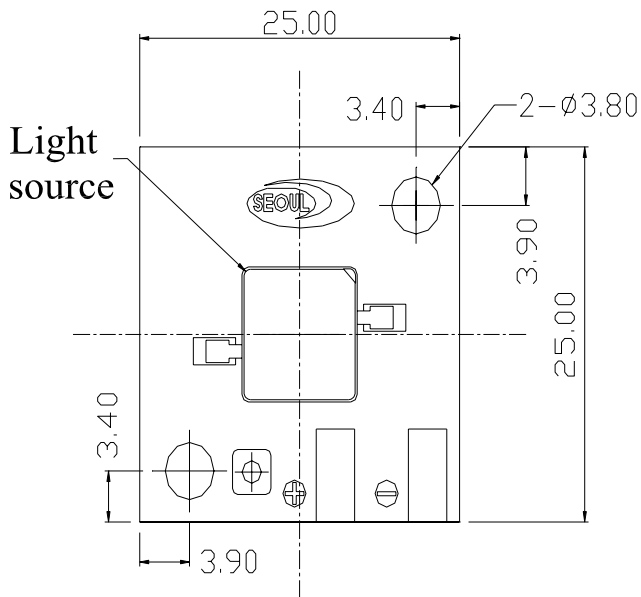

<Rectangular type>

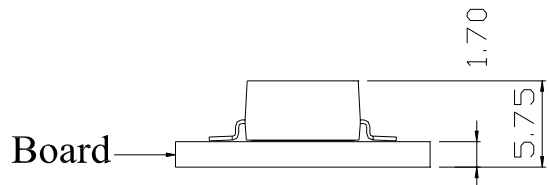
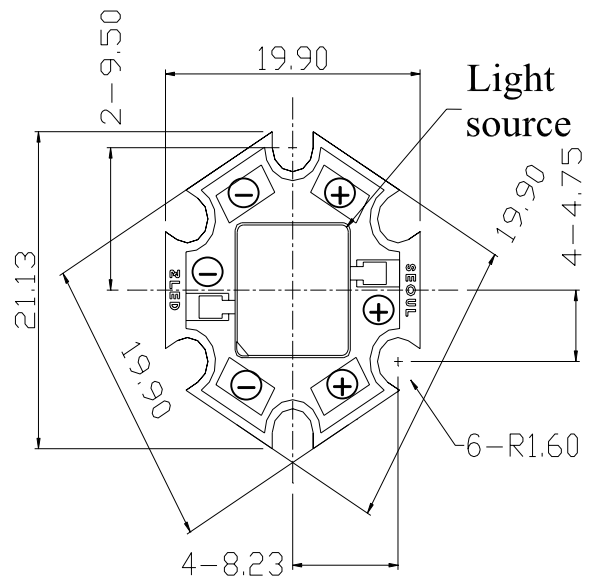

<Star type>

### Notes :

1. All dimensions are in millimeters. (tolerance :  $\pm 0.2$  )
2. Scale : none

\*The appearance and specifications of the product may be changed for improvement without notice.

## Characteristics for Z-Power LED

### 1. Pure White (W10291, W10292)

1-1 Electro-Optical characteristics at  $I_F=700\text{mA}$ ,  $T_A=25^\circ\text{C}$

Parameter	Symbol	Value			Unit
		Min	Typ	Max	
Luminous Flux [1]	$\Phi_V$ [2]	70	103	-	lm
Correlated Color Temperature [3]	CCT	-	6500	-	K
CRI	$R_a$	-	70	-	-
Forward Voltage [4]	$V_F$	3.0	3.5	4.0	V
View Angle	$2\theta$ 1/2	110			deg.
Thermal resistance [5]	$R\theta_{J-B}$	6			$^\circ\text{C}/\text{W}$
Thermal resistance [6]	$R\theta_{J-C}$	4.5			$^\circ\text{C}/\text{W}$

1-2 Absolute Maximum Ratings

Parameter	Symbol	Value	Unit
Forward Current	$I_F$	0.8	A
Power Dissipation	$P_D$	3.2	W
Junction Temperature	$T_j$	125	$^\circ\text{C}$
Operating Temperature	$T_{opr}$	-30 ~ +85	$^\circ\text{C}$
Storage Temperature	$T_{stg}$	-40 ~ +120	$^\circ\text{C}$
ESD Sensitivity [7]	-	$\pm 20,000\text{V HBM}$	-

\*Notes :

- [1] SSC maintains a tolerance of  $\pm 10\%$  on flux and power measurements.
- [2]  $\Phi_V$  is the total luminous flux output as measured with an integrated sphere.
- [3] Correlated Color Temperature is derived from the CIE 1931 Chromaticity diagram.  
CCT  $\pm 5\%$  tester tolerance
- [4] A tolerance of  $\pm 0.06\text{V}$  on forward voltage measurements
- [5], [6]  $R\theta_{J-B}$  is measured with a SSC metal core pcb. ( $25^\circ\text{C} \leq T_j \leq 110^\circ\text{C}$ )  
 $R\theta_{J-C}$  is measured with only emitter. ( $25^\circ\text{C} \leq T_j \leq 110^\circ\text{C}$ )  
Break voltage of Metal PCB is 6.5kVAC
- [7] It is included the zener chip to protect the product from ESD.

-----Caution-----

1. Please do not drive at rated current more than 5 sec. without proper heat sink
2. The chromaticity coordinate of the LEDs can shift approximately  $x=0.02$ ,  $y=0.03$  in the direction of blue 1000 hours later
3. The chromaticity coordinate of the LEDs can be shift as temperature of junction.



## 2. Natural white (S10291, S10292)

2-1 Electro-Optical characteristics at  $I_F=700\text{mA}$ ,  $T_A=25^\circ\text{C}$

Parameter	Symbol	Value			Unit
		Min	Typ	Max	
Luminous Flux [1]	$\Phi_V$ [2]	-	70	-	lm
Correlated Color Temperature [3]	CCT	-	4000	-	K
CRI	$R_a$	-	73	-	-
Forward Voltage [4]	$V_F$	3.0	3.5	4.0	V
View Angle	$2\theta$ 1/2	110			deg.
Thermal resistance [5]	$R\theta_{J-B}$	6			$^\circ\text{C}/\text{W}$
Thermal resistance [6]	$R\theta_{J-C}$	4.5			$^\circ\text{C}/\text{W}$

### 2-2 Absolute Maximum Ratings

Parameter	Symbol	Value	Unit
Forward Current	$I_F$	0.8	A
Power Dissipation	$P_D$	3.2	W
Junction Temperature	$T_j$	125	$^\circ\text{C}$
Operating Temperature	$T_{opr}$	-30 ~ +85	$^\circ\text{C}$
Storage Temperature	$T_{stg}$	-40 ~ +120	$^\circ\text{C}$
ESD Sensitivity [7]	-	$\pm 20,000\text{V HBM}$	-

\*Notes :

- [1] SSC maintains a tolerance of  $\pm 10\%$  on flux and power measurements.
- [2]  $\Phi_V$  is the total luminous flux output as measured with an integrated sphere.
- [3] Correlated Color Temperature is derived from the CIE 1931 Chromaticity diagram.  
CCT  $\pm 5\%$  tester tolerance
- [4] A tolerance of  $\pm 0.06\text{V}$  on forward voltage measurements
- [5], [6]  $R\theta_{J-B}$  is measured with a SSC metal core pcb. ( $25^\circ\text{C} \leq T_j \leq 110^\circ\text{C}$ )  
 $R\theta_{J-C}$  is measured with only emitter. ( $25^\circ\text{C} \leq T_j \leq 110^\circ\text{C}$ )  
Break voltage of Metal PCB is 6.5kVAC
- [7] It is included the zener chip to protect the product from ESD.

-----Caution-----

1. Please do not drive at rated current more than 5 sec. without proper heat sink
2. The chromaticity coordinate of the LEDs can shift approximately  $x=0.02$ ,  $y=0.03$  in the direction of blue 1000 hours later
3. The chromaticity coordinate of the LEDs can be shift as temperature of junction.



### 3. Warm White (N10291, N10292)

3-1 Electro-Optical characteristics at  $I_F=700\text{mA}$ ,  $T_A=25^\circ\text{C}$

Parameter	Symbol	Value			Unit
		Min	Typ	Max	
Luminous Flux <sup>[1]</sup>	$\Phi_V$ <sup>[2]</sup>	54	60	-	lm
Correlated Color Temperature <sup>[3]</sup>	CCT	-	3000	-	K
CRI	$R_a$	-	80	-	-
Forward Voltage <sup>[4]</sup>	$V_F$	3.0	3.5	4.0	V
View Angle	$2\Theta$ 1/2	110			deg.
Thermal resistance <sup>[5]</sup>	$R\Theta_{J-B}$	6			$^\circ\text{C}/\text{W}$
Thermal resistance <sup>[6]</sup>	$R\Theta_{J-C}$	4.5			$^\circ\text{C}/\text{W}$

### 3-2 Absolute Maximum Ratings

Parameter	Symbol	Value	Unit
Forward Current	$I_F$	0.8	A
Power Dissipation	$P_D$	3.2	W
Junction Temperature	$T_j$	125	$^\circ\text{C}$
Operating Temperature	$T_{opr}$	-30 ~ +85	$^\circ\text{C}$
Storage Temperature	$T_{stg}$	-40 ~ +120	$^\circ\text{C}$
ESD Sensitivity <sup>[7]</sup>	-	$\pm 20,000\text{V HBM}$	-

\*Notes :

- [1] SSC maintains a tolerance of  $\pm 10\%$  on flux and power measurements.
- [2]  $\Phi_V$  is the total luminous flux output as measured with an integrated sphere.
- [3] Correlated Color Temperature is derived from the CIE 1931 Chromaticity diagram.  
CCT  $\pm 5\%$  tester tolerance
- [4] A tolerance of  $\pm 0.06\text{V}$  on forward voltage measurements
- [5], [6]  $R\Theta_{J-B}$  is measured with a SSC metal core pcb. ( $25^\circ\text{C} \leq T_j \leq 110^\circ\text{C}$ )  
 $R\Theta_{J-C}$  is measured with only emitter. ( $25^\circ\text{C} \leq T_j \leq 110^\circ\text{C}$ )  
Break voltage of Metal PCB is 6.5kVAC
- [7] It is included the zener chip to protect the product from ESD.

-----Caution-----

1. Please do not drive at rated current more than 5 sec. without proper heat sink
2. The chromaticity coordinate of the LEDs can shift approximately  $x=0.02$ ,  $y=0.03$  in the direction of blue 1000 hours later
3. The chromaticity coordinate of the LEDs can be shift as temperature of junction.



#### 4. Royal Blue (D10291, D10292)

5-1 Electro-Optical characteristics at  $I_F=700\text{mA}$ ,  $T_A=25^\circ\text{C}$

Parameter	Symbol	Value			Unit
		Min	Typ	Max	
Radiant Flux [1]	$\Phi_V$ [2]	280	350	-	mW
Dominant Wavelength [3]	$\lambda_D$	455	460	465	nm
Forward Voltage [4]	$V_F$	3.0	3.5	4.0	V
View Angle	$2\Theta$ 1/2	130			deg.
Thermal Resistance [5]	$R\Theta_{J-B}$	6			$^\circ\text{C}/\text{W}$
Thermal Resistance [6]	$R\Theta_{J-C}$	4.5			$^\circ\text{C}/\text{W}$

5-2 Absolute Maximum Ratings

Parameter	Symbol	Value	Unit
Forward Current	$I_F$	0.8	A
Power Dissipation	$P_D$	3.2	W
Junction Temperature	$T_J$	125	$^\circ\text{C}$
Operating Temperature	$T_{opr}$	-30 ~ +85	$^\circ\text{C}$
Storage Temperature	$T_{stg}$	-40 ~ +120	$^\circ\text{C}$
ESD Sensitivity [7]	-	$\pm 20,000\text{V HBM}$	-

\*Notes :

- [1] SSC maintains a tolerance of  $\pm 10\%$  on flux and power measurements.
- [2]  $\Phi_V$  is the total luminous flux output as measured with an integrated sphere.
- [3] Correlated Color Temperature is derived from the CIE 1931 Chromaticity diagram.  
CCT  $\pm 5\%$  tester tolerance
- [4] A tolerance of  $\pm 0.06\text{V}$  on forward voltage measurements
- [5], [6]  $R\Theta_{J-B}$  is measured with a SSC metal core pcb. ( $25^\circ\text{C} \leq T_J \leq 110^\circ\text{C}$ )  
 $R\Theta_{J-C}$  is measured with only emitter. ( $25^\circ\text{C} \leq T_J \leq 110^\circ\text{C}$ )  
Break voltage of Metal PCB is 6.5kVAC
- [7] It is included the zener chip to protect the product from ESD.

-----Caution-----

1. Please do not drive at rated current more than 5 sec. without proper heat sink
2. Blue power light sources represented here are IEC825 Class 2 for eye safety





## 5. Blue (B10291, B10292)

5-1 Electro-Optical characteristics at  $I_F=700\text{mA}$ ,  $T_A=25^\circ\text{C}$

Parameter	Symbol	Value			Unit
		Min	Typ	Max	
Luminous Flux [1]	$\Phi_V$ [2]	14.5	18	-	lm
Dominant Wavelength [3]	$\lambda_D$	455	460	475	nm
Forward Voltage [4]	$V_F$	3.0	3.5	4.0	V
View Angle	$2\Theta$ 1/2	130			deg.
Thermal Resistance [5]	$R\Theta_{J-B}$	6			$^\circ\text{C}/\text{W}$
Thermal Resistance [6]	$R\Theta_{J-C}$	4.5			$^\circ\text{C}/\text{W}$

5-2 Absolute Maximum Ratings

Parameter	Symbol	Value	Unit
Forward Current	$I_F$	0.8	A
Power Dissipation	$P_D$	3.2	W
Junction Temperature	$T_J$	125	$^\circ\text{C}$
Operating Temperature	$T_{opr}$	-30 ~ +85	$^\circ\text{C}$
Storage Temperature	$T_{stg}$	-40 ~ +120	$^\circ\text{C}$
ESD Sensitivity [7]	-	$\pm 20,000\text{V HBM}$	-

\*Notes :

- [1] SSC maintains a tolerance of  $\pm 10\%$  on flux and power measurements.
- [2]  $\Phi_V$  is the total luminous flux output as measured with an integrated sphere.
- [3] Correlated Color Temperature is derived from the CIE 1931 Chromaticity diagram.  
CCT  $\pm 5\%$  tester tolerance
- [4] A tolerance of  $\pm 0.06\text{V}$  on forward voltage measurements
- [5], [6]  $R\Theta_{J-B}$  is measured with a SSC metal core pcb. ( $25^\circ\text{C} \leq T_J \leq 110^\circ\text{C}$ )  
 $R\Theta_{J-C}$  is measured with only emitter. ( $25^\circ\text{C} \leq T_J \leq 110^\circ\text{C}$ )  
Break voltage of Metal PCB is 6.5kVAC
- [7] It is included the zener chip to protect the product from ESD.

-----Caution-----

1. Please do not drive at rated current more than 5 sec. without proper heat sink
2. Blue power light sources represented here are IEC825 Class 2 for eye safety



## 6. Cyan (C10291, C10292)

6-1 Electro-Optical characteristics at  $I_F=700\text{mA}$ ,  $T_A=25^\circ\text{C}$

Parameter	Symbol	Value			Unit
		Min	Typ	Max	
Luminous Flux [1]	$\Phi_V$ [2]	54	78	-	lm
Dominant Wavelength [3]	$\lambda_D$	500	505	510	nm
Forward Voltage [4]	$V_F$	3.0	3.5	4.0	V
View Angle	$2\Theta$ 1/2	130			deg.
Thermal Resistance [5]	$R\Theta_{J-B}$	6			$^\circ\text{C}/\text{W}$
Thermal Resistance [6]	$R\Theta_{J-C}$	4.5			$^\circ\text{C}/\text{W}$

### 6-2 Absolute Maximum Ratings

Parameter	Symbol	Value	Unit
Forward Current	$I_F$	0.8	A
Power Dissipation	$P_D$	3.2	W
Junction Temperature	$T_j$	125	$^\circ\text{C}$
Operating Temperature	$T_{opr}$	-30 ~ +85	$^\circ\text{C}$
Storage Temperature	$T_{stg}$	-40 ~ +120	$^\circ\text{C}$
ESD Sensitivity [7]	-	$\pm 20,000\text{V HBM}$	-

\*Notes :

[1] SSC maintains a tolerance of  $\pm 10\%$  on flux and power measurements.

[2]  $\Phi_V$  is the total luminous flux output as measured with an integrated sphere.

[3] Correlated Color Temperature is derived from the CIE 1931 Chromaticity diagram.

CCT  $\pm 5\%$  tester tolerance

[4] A tolerance of  $\pm 0.06\text{V}$  on forward voltage measurements

[5], [6]  $R\Theta_{J-B}$  is measured with a SSC metal core pcb. ( $25^\circ\text{C} \leq T_j \leq 110^\circ\text{C}$ )

$R\Theta_{J-C}$  is measured with only emitter. ( $25^\circ\text{C} \leq T_j \leq 110^\circ\text{C}$ )

Break voltage of Metal PCB is 6.5kVAC

[7] It is included the zener chip to protect the product from ESD.

-----Caution-----

**Please do not drive at rated current more than 5 sec. without proper heat sink**



## 7. Green (G10291, G10292)

7-1 Electro-Optical characteristics at  $I_F=700\text{mA}$ ,  $T_A=25^\circ\text{C}$

Parameter	Symbol	Value			Unit
		Min	Typ	Max	
Luminous Flux [1]	$\Phi_V$ [2]	54	93	-	lm
Dominant Wavelength [3]	$\lambda_D$	520	527	535	nm
Forward Voltage [4]	$V_F$	3.0	3.5	4.0	V
View Angle	$2\Theta$ 1/2	130			deg.
Thermal Resistance [5]	$R\Theta_{J-B}$	6			$^\circ\text{C}/\text{W}$
Thermal Resistance [6]	$R\Theta_{J-C}$	4.5			$^\circ\text{C}/\text{W}$

7-2 Absolute Maximum Ratings

Parameter	Symbol	Value	Unit
Forward Current	$I_F$	0.8	A
Power Dissipation	$P_D$	3.2	W
Junction Temperature	$T_j$	125	$^\circ\text{C}$
Operating Temperature	$T_{opr}$	-30 ~ +85	$^\circ\text{C}$
Storage Temperature	$T_{stg}$	-40 ~ +120	$^\circ\text{C}$
ESD Sensitivity [7]	-	$\pm 20,000\text{V HBM}$	-

\*Notes :

[1] SSC maintains a tolerance of  $\pm 10\%$  on flux and power measurements.

[2]  $\Phi_V$  is the total luminous flux output as measured with an integrated sphere.

[3] Correlated Color Temperature is derived from the CIE 1931 Chromaticity diagram.

CCT  $\pm 5\%$  tester tolerance

[4] A tolerance of  $\pm 0.06\text{V}$  on forward voltage measurements

[5], [6]  $R\Theta_{J-B}$  is measured with a SSC metal core pcb. ( $25^\circ\text{C} \leq T_j \leq 110^\circ\text{C}$ )

$R\Theta_{J-C}$  is measured with only emitter. ( $25^\circ\text{C} \leq T_j \leq 110^\circ\text{C}$ )

Break voltage of Metal PCB is 6.5kVAC

[7] It is included the zener chip to protect the product from ESD.

### -----Caution-----

**Please do not drive at rated current more than 5 sec. without proper heat sink**



## 8. Amber (A10291, A10292)

8-1 Electro-Optical characteristics at  $I_F=700\text{mA}$ ,  $T_A=25^\circ\text{C}$

Parameter	Symbol	Value			Unit
		Min	Typ	Max	
Luminous Flux [1]	$\Phi_V$ [2]	54	75	-	lm
Dominant Wavelength [3]	$\lambda_D$	585	590	595	nm
Forward Voltage [4]	$V_F$	2.0	2.5	3.0	V
View Angle	$2\Theta$ 1/2	128			deg.
Thermal Resistance [5]	$R\Theta_{J-B}$	8			$^\circ\text{C}/\text{W}$
Thermal Resistance [6]	$R\Theta_{J-C}$	6.5			$^\circ\text{C}/\text{W}$

### 8-2 Absolute Maximum Ratings

Parameter	Symbol	Value	Unit
Forward Current	$I_F$	0.8	A
Power Dissipation	$P_D$	2.4	W
Junction Temperature	$T_j$	100	$^\circ\text{C}$
Operating Temperature	$T_{opr}$	-30 ~ +85	$^\circ\text{C}$
Storage Temperature	$T_{stg}$	-40 ~ +120	$^\circ\text{C}$
ESD Sensitivity [7]	-	$\pm 20,000\text{V HBM}$	-

**\*Notes :**

- [1] SSC maintains a tolerance of  $\pm 10\%$  on flux and power measurements.
- [2]  $\Phi_V$  is the total luminous flux output as measured with an integrated sphere.
- [3] Correlated Color Temperature is derived from the CIE 1931 Chromaticity diagram.  
CCT  $\pm 5\%$  tester tolerance
- [4] A tolerance of  $\pm 0.06\text{V}$  on forward voltage measurements
- [5], [6]  $R\Theta_{J-B}$  is measured with a SSC metal core pcb. ( $25^\circ\text{C} \leq T_j \leq 110^\circ\text{C}$ )  
 $R\Theta_{J-C}$  is measured with only emitter. ( $25^\circ\text{C} \leq T_j \leq 110^\circ\text{C}$ )  
Break voltage of Metal PCB is 6.5kVAC
- [7] It is included the zener chip to protect the product from ESD.

### -----Caution-----

**Please do not drive at rated current more than 5 sec. without proper heat sink**



## 9. Red (R10291, R10292)

9-1 Electro-Optical characteristics at  $I_F=700\text{mA}$ ,  $T_A=25^\circ\text{C}$

Parameter	Symbol	Value			Unit
		Min	Typ	Max	
Luminous Flux [1]	$\Phi_V$ [2]	54	60	-	lm
Dominant Wavelength [3]	$\lambda_D$	618	625	632	nm
Forward Voltage [4]	$V_F$	2.0	2.5	3.0	V
View Angle	$2\Theta$ 1/2	128			deg.
Thermal Resistance [5]	$R\Theta_{J-B}$	8			$^\circ\text{C}/\text{W}$
Thermal Resistance [6]	$R\Theta_{J-C}$	6.5			$^\circ\text{C}/\text{W}$

9-2 Absolute Maximum Ratings

Parameter	Symbol	Value	Unit
Forward Current	$I_F$	0.8	A
Power Dissipation	$P_D$	2.4	W
Junction Temperature	$T_j$	100	$^\circ\text{C}$
Operating Temperature	$T_{opr}$	-30 ~ +85	$^\circ\text{C}$
Storage Temperature	$T_{stg}$	-40 ~ +120	$^\circ\text{C}$
ESD Sensitivity [7]	-	$\pm 20,000\text{V}$ HBM	-

\*Notes :

- [1] SSC maintains a tolerance of  $\pm 10\%$  on flux and power measurements.
- [2]  $\Phi_V$  is the total luminous flux output as measured with an integrated sphere.
- [3] Correlated Color Temperature is derived from the CIE 1931 Chromaticity diagram.  
CCT  $\pm 5\%$  tester tolerance
- [4] A tolerance of  $\pm 0.06\text{V}$  on forward voltage measurements
- [5], [6]  $R\Theta_{J-B}$  is measured with a SSC metal core pcb. ( $25^\circ\text{C} \leq T_j \leq 110^\circ\text{C}$ )  
 $R\Theta_{J-C}$  is measured with only emitter. ( $25^\circ\text{C} \leq T_j \leq 110^\circ\text{C}$ )  
Break voltage of Metal PCB is 6.5kVAC
- [7] It is included the zener chip to protect the product from ESD.

### -----Caution-----

**Please do not drive at rated current more than 5 sec. without proper heat sink**



### 1. Pure White

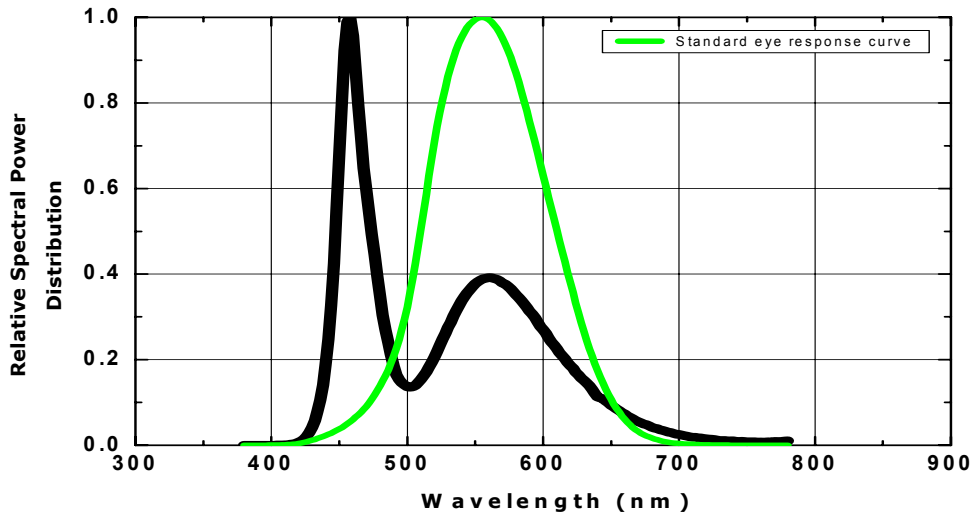

### 2. Warm White

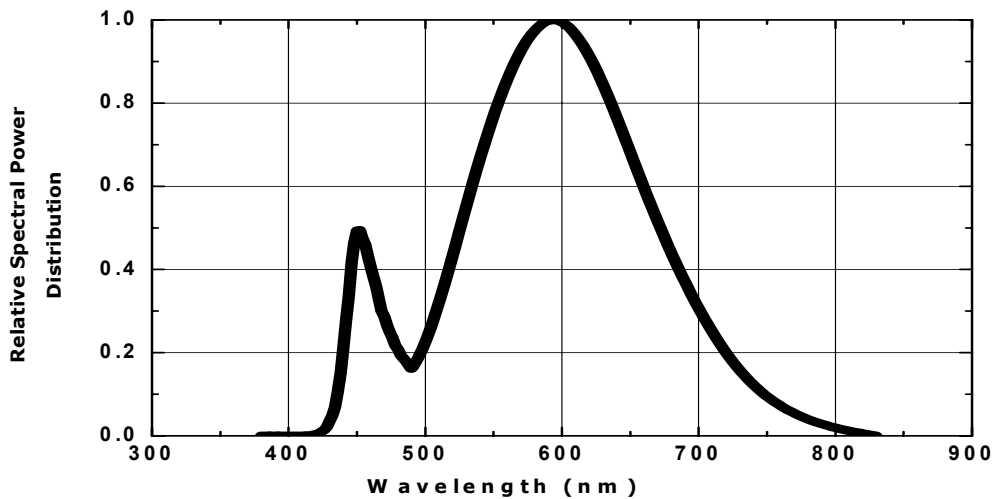

### 3. Natural white

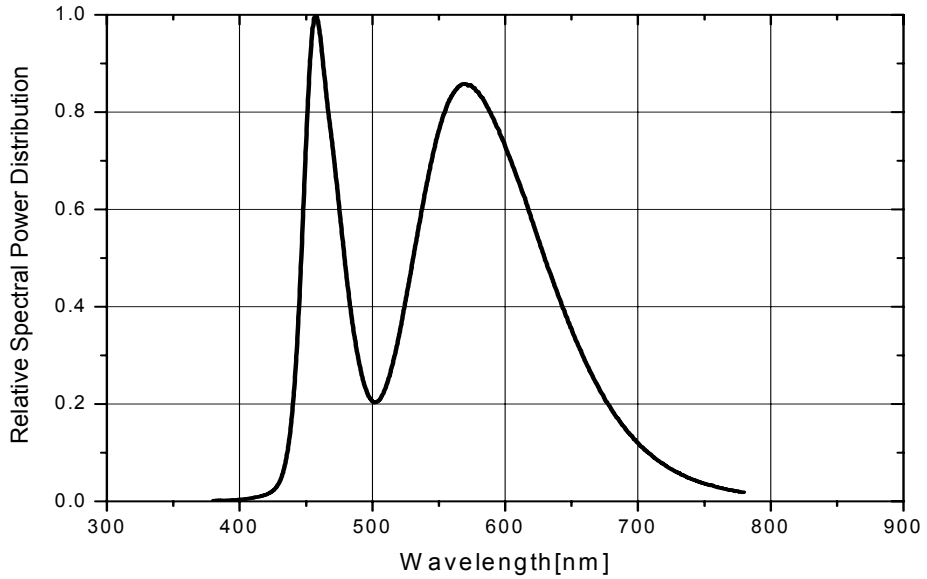

### 4. Blue Cyan Green Amber Red

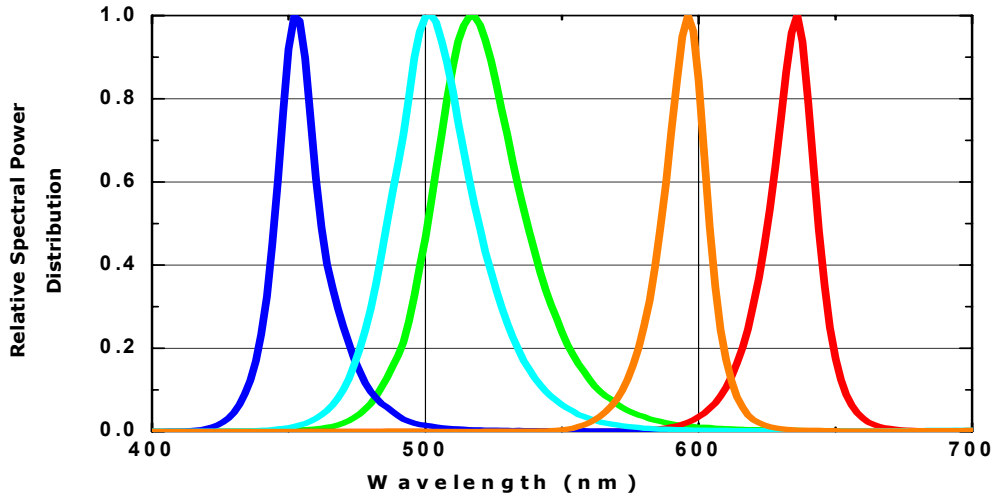

## Forward Current Characteristics

### 1. Forward Voltage vs. Forward Current, $T_A=25^\circ\text{C}$

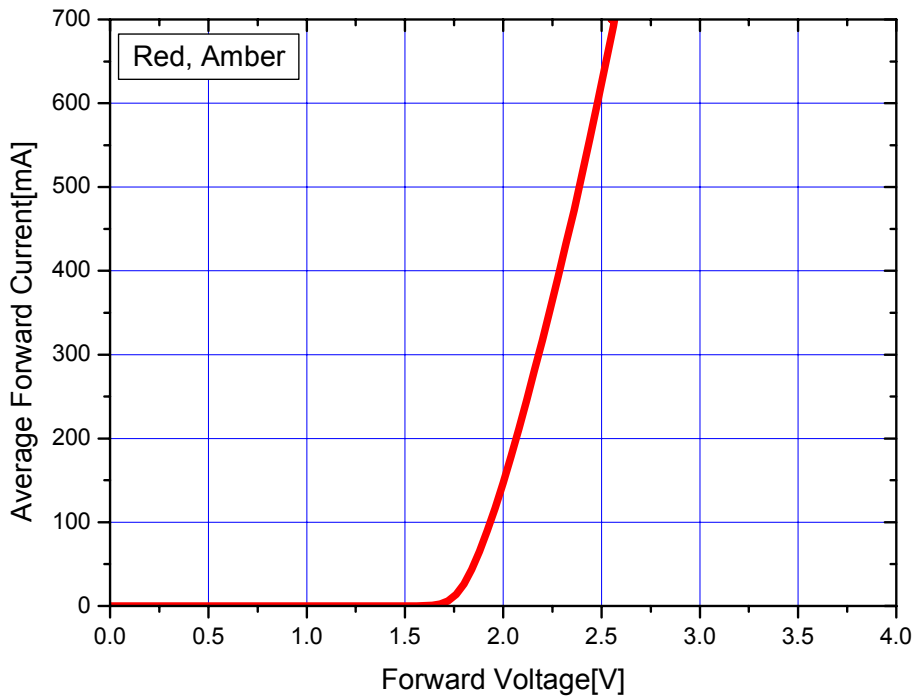
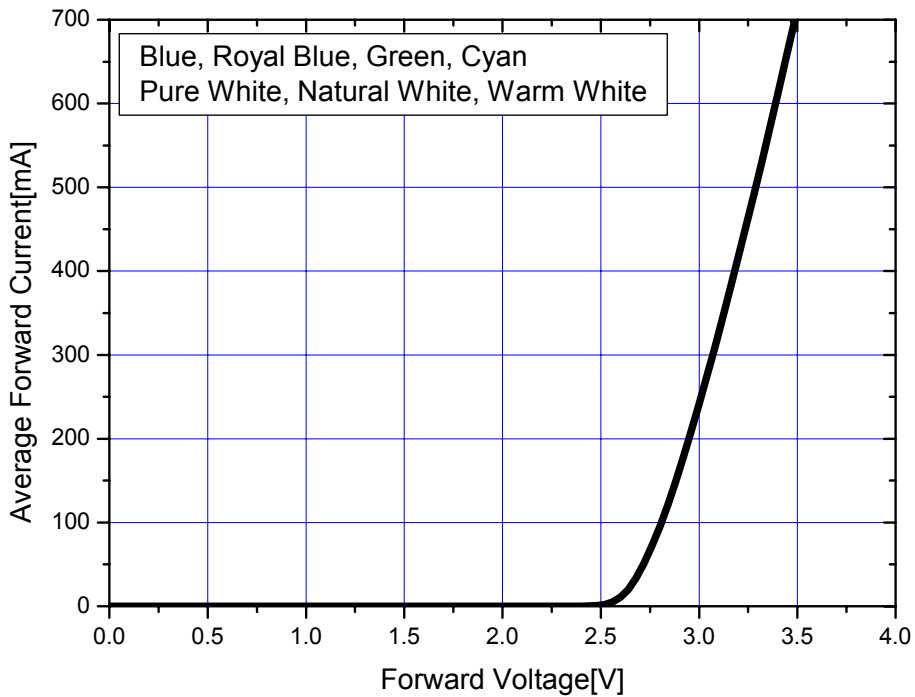



## 2. Forward Current vs. Normalized Relative Luminous Flux, $T_A=25^\circ\text{C}$

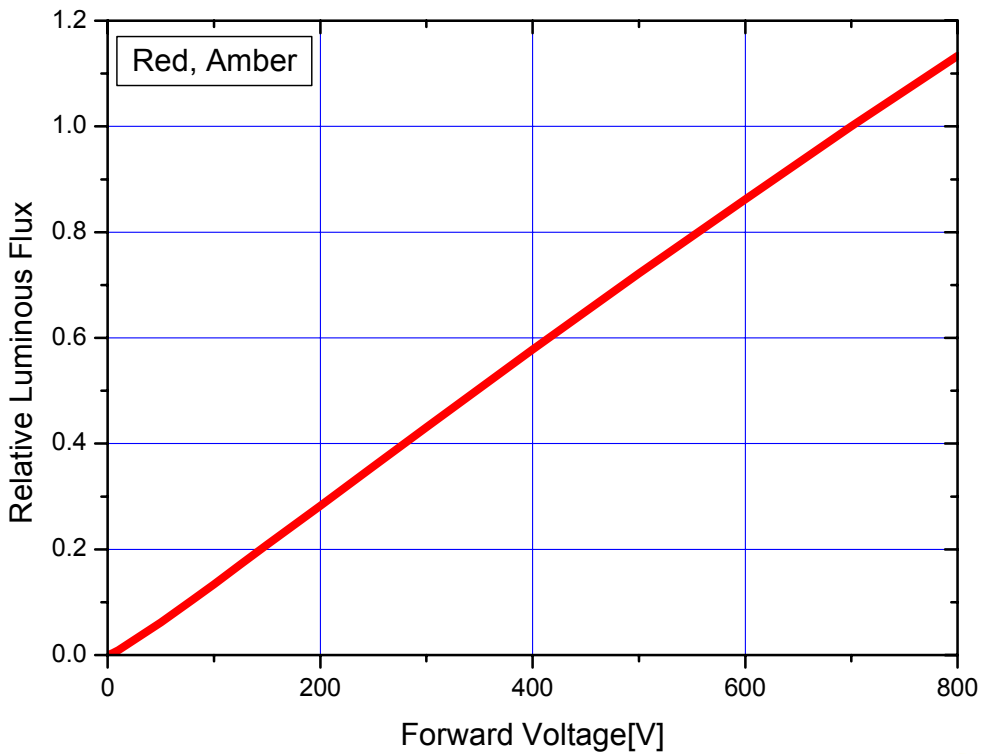
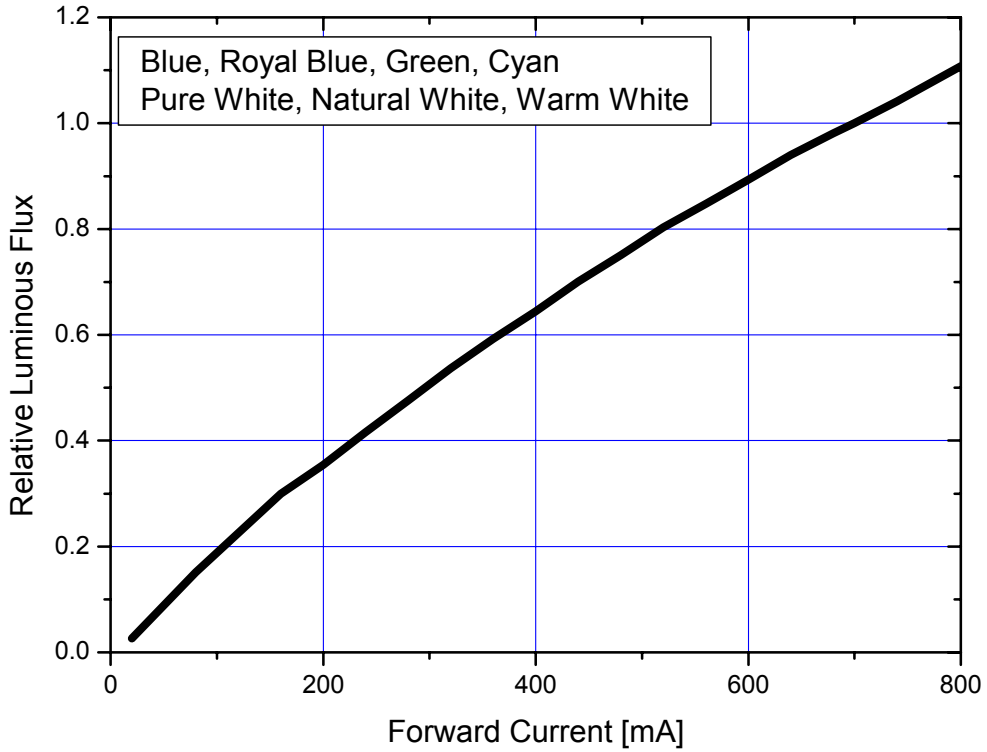

### 3. Forward Current vs Chromaticity coordinate $T_A=25^\circ\text{C}$

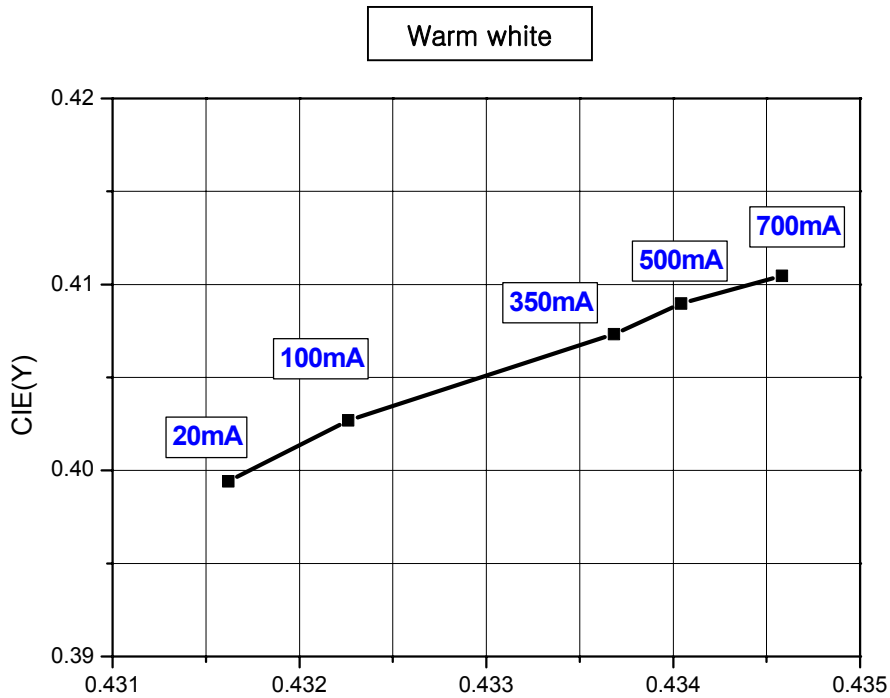
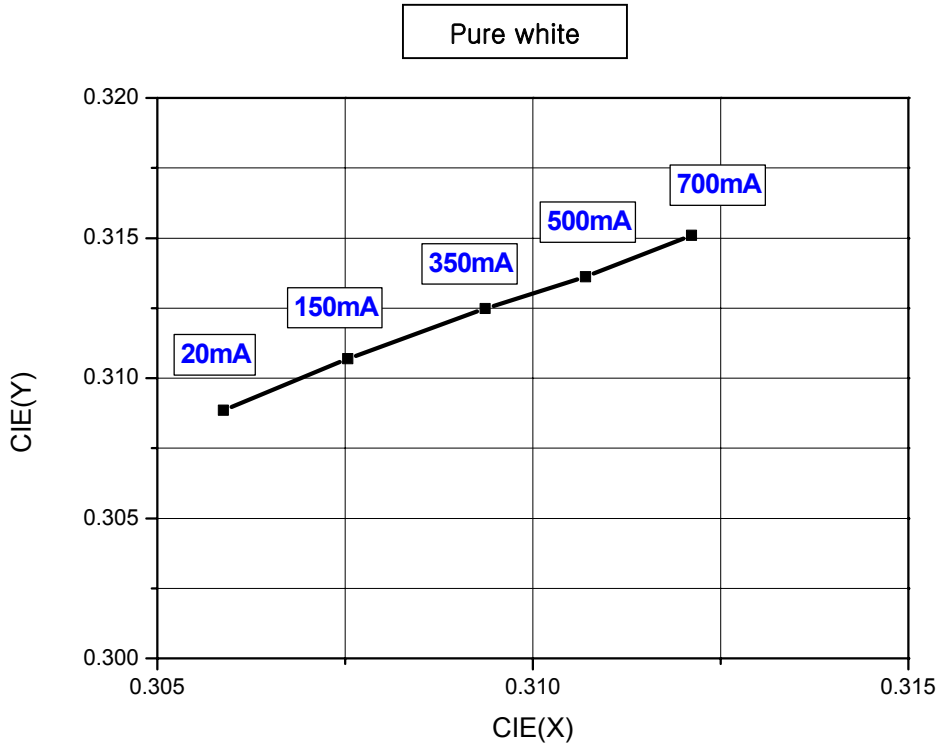

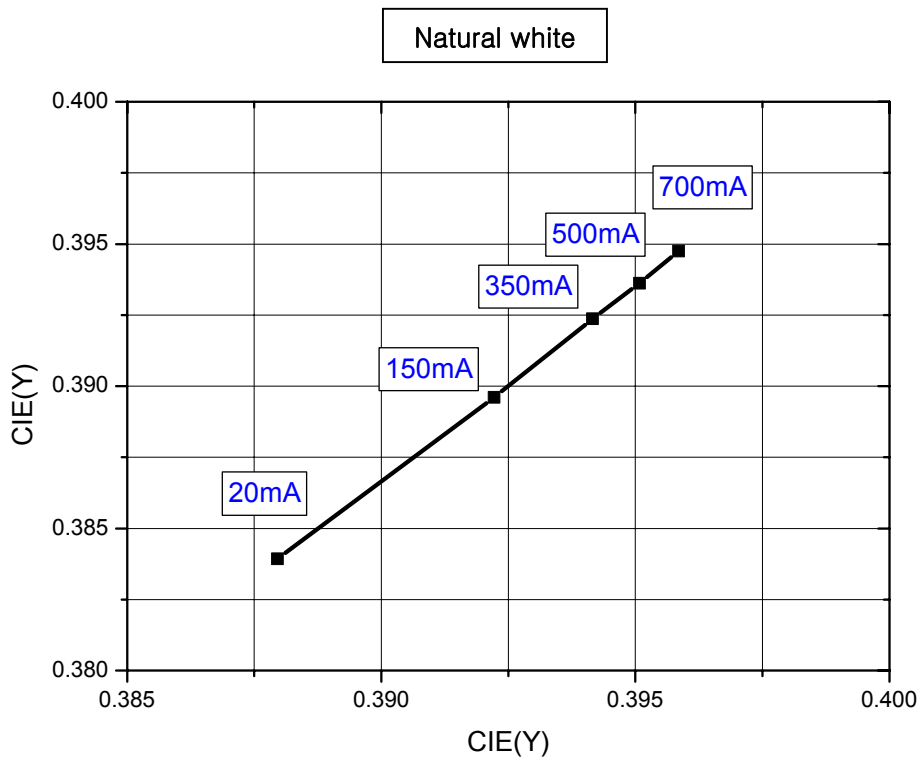

#### 4. Forward Current vs Wavelength shift $T_A=25^\circ\text{C}$

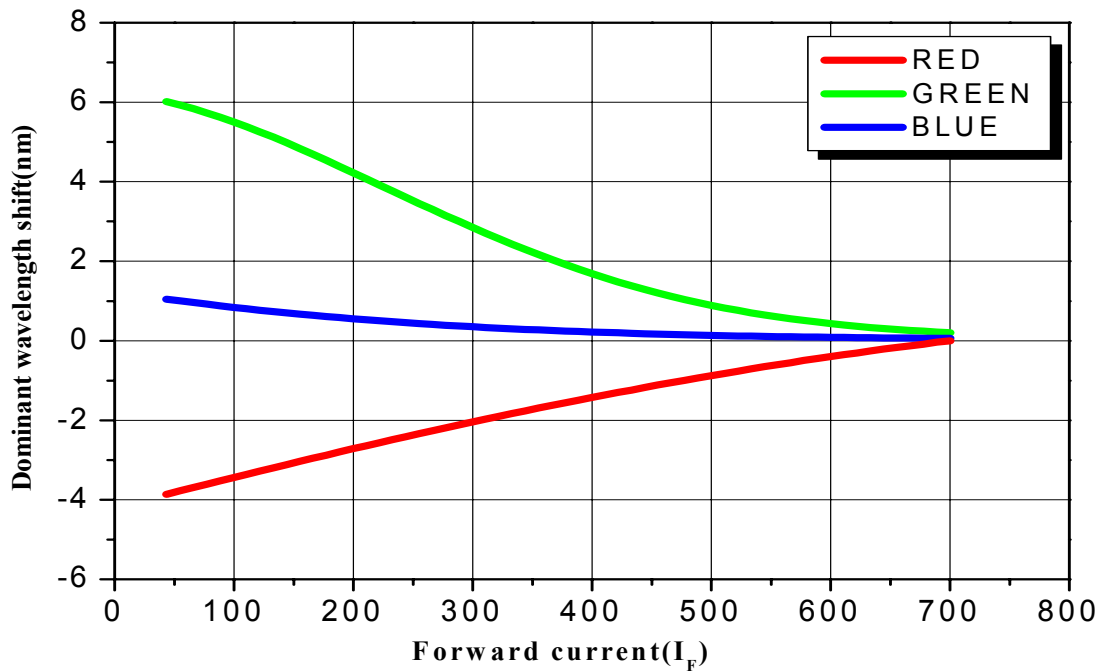

## Junction Temperature Characteristics

### 1. Temperature of Junction vs. Relative Light Output for Blue, Green, Red $T_A=25^\circ\text{C}$

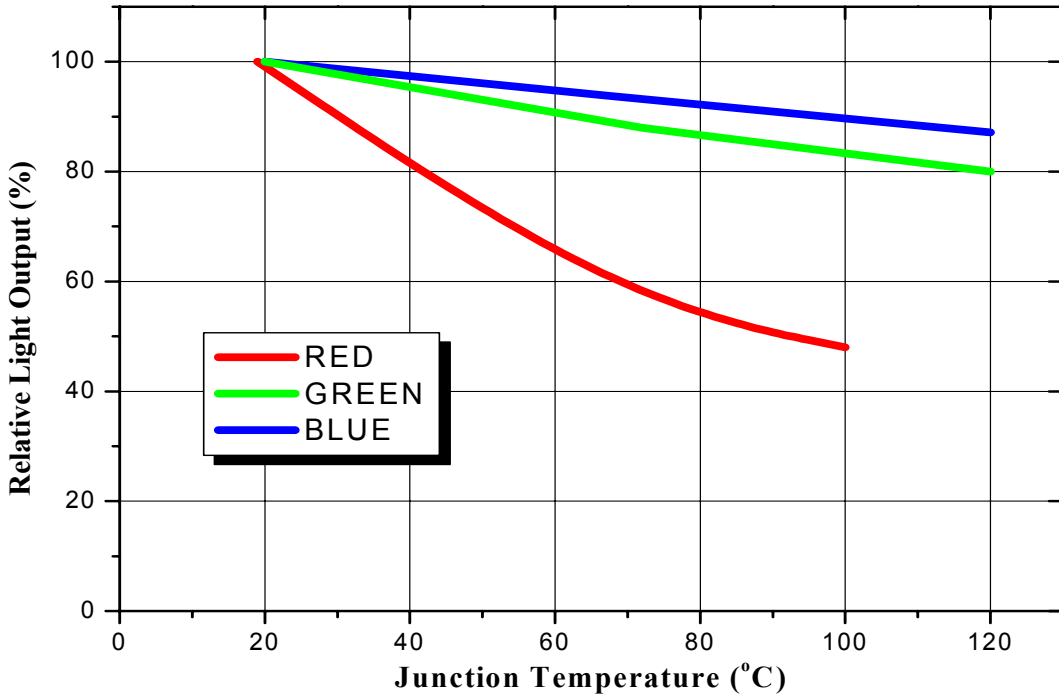

# Typical Dome Type Radiation pattern

## 1. Pure White, Warm White, Natural White

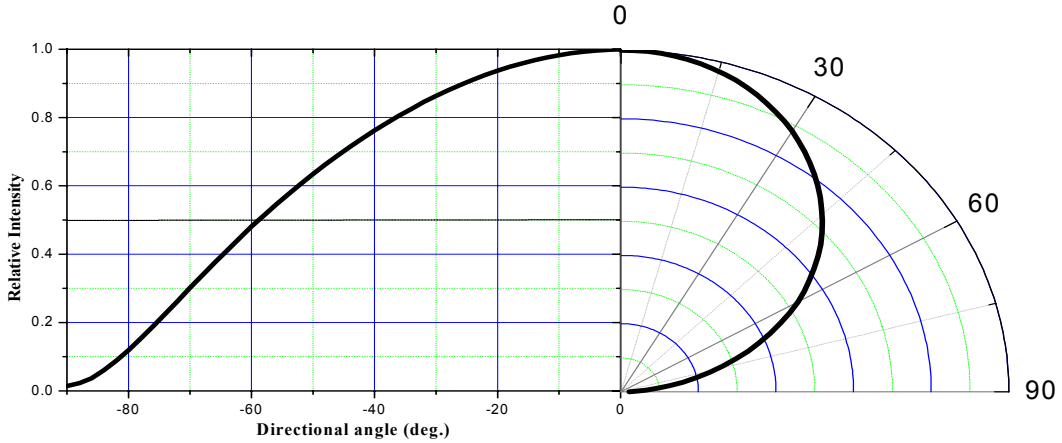

## 2. Blue, Royal Blue, Cyan, Green

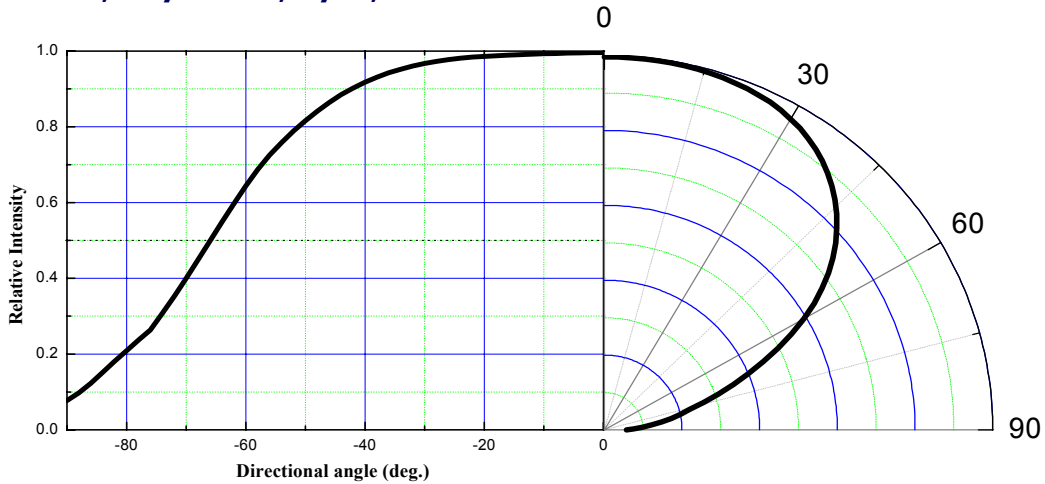

## 3. Amber, Red

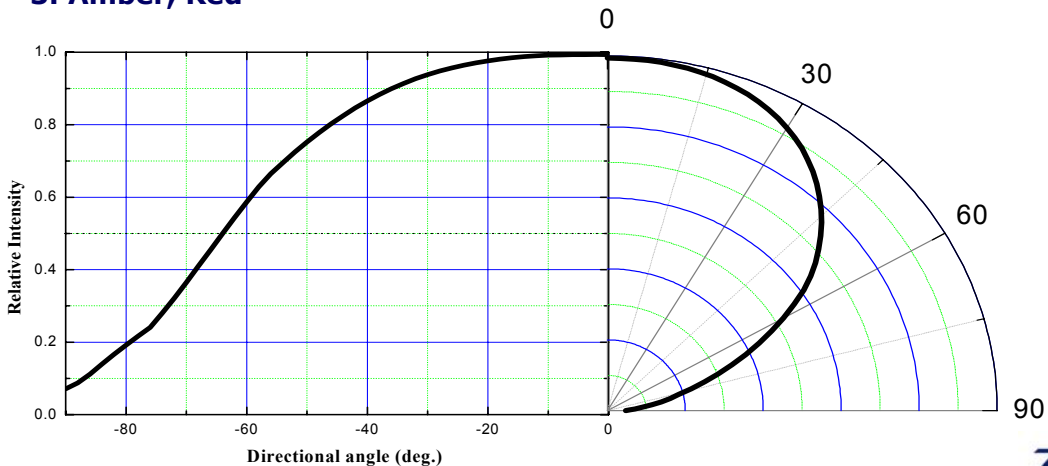

## Ambient Temperature vs Allowable Forward Current

### 1. Pure White, Warm White, Blue, Royal Blue, Cyan, Green, Natural white ( $T_{JMAX} = 125\text{ }^{\circ}\text{C}$ )

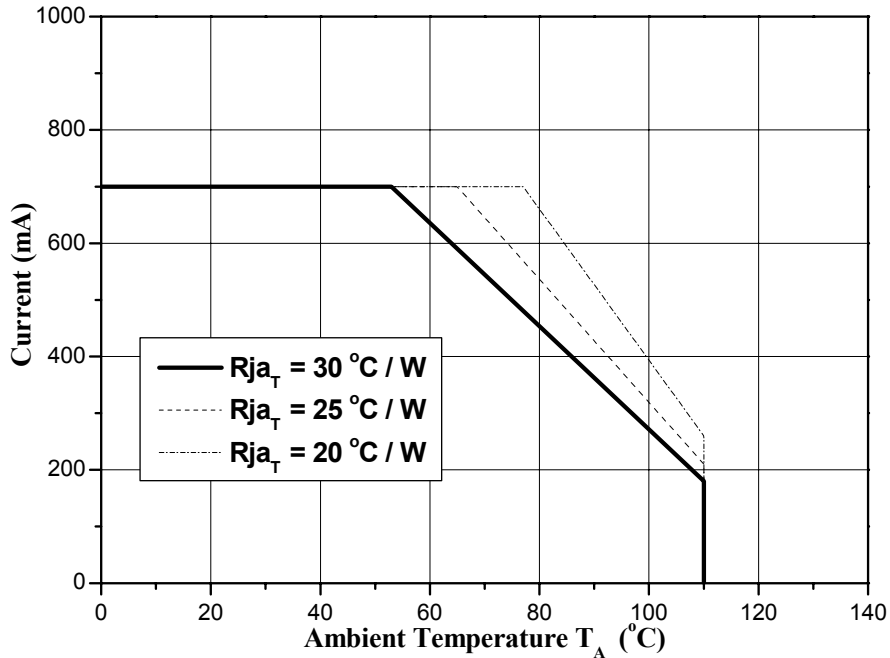

### 2. Amber, Red ( $T_{JMAX} = 100\text{ }^{\circ}\text{C}$ )

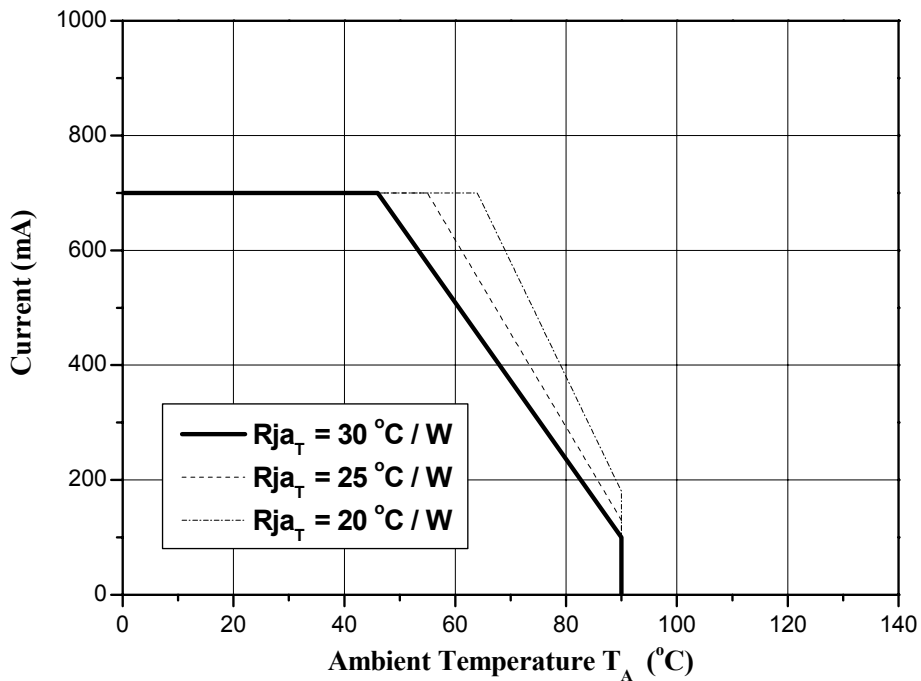

## Recommended Soldering

### 1. Solder pad

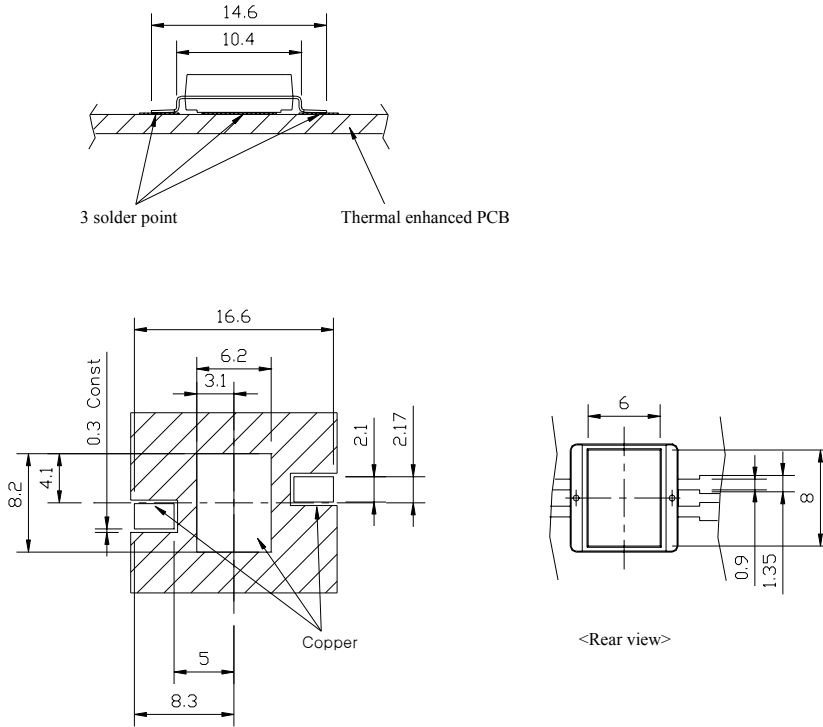

### 2. Solder paste pattern

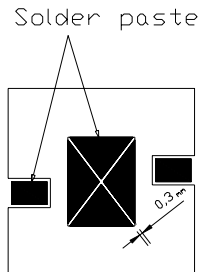

1. Paste thickness : 0.2mm

Note :

1. All dimensions are in millimeters (tolerance :  $\pm 0.2$  )
2. Scale none

\*The appearance and specifications of the product may be changed for improvement without notice.

### 1. Reflow Soldering Conditions / Profile

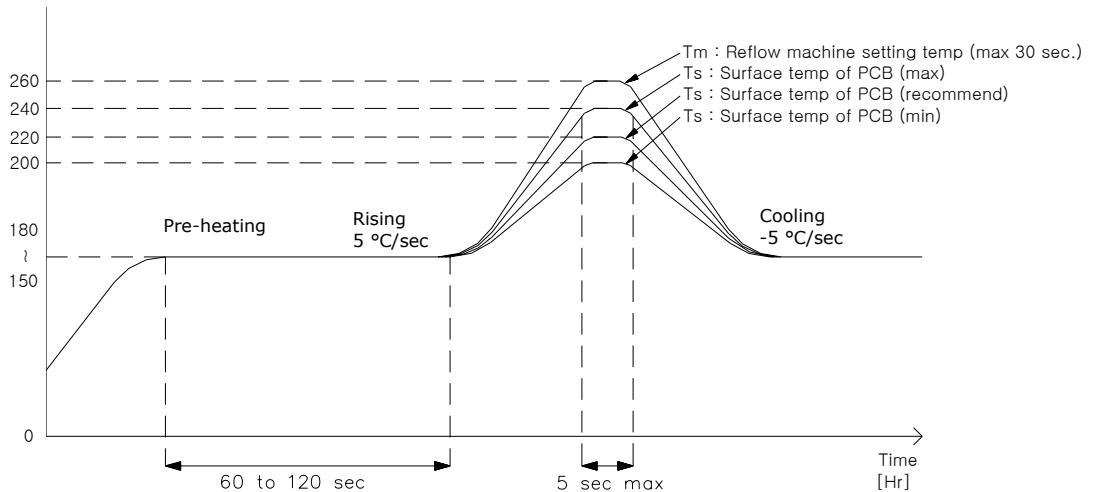

### 2. Hand Soldering conditions

Lead : Not more than 3 seconds @MAX280°C  
Slug : Use a thermal-adhesives

#### \* Caution

1. Reflow soldering should not be done more than one time.
2. Repairing should not be done after the LEDs have been soldered. When repairing is unavoidable, suitable tools have to be used.
3. Die slug is to be soldered.
4. When soldering, do not put stress on the LEDs during heating.
5. After soldering, do not warp the circuit board.
6. Recommend to use a convection type reflow machine with 7 ~ 8 zones.



# Rectangular Type Reel Packaging - Rectangular type

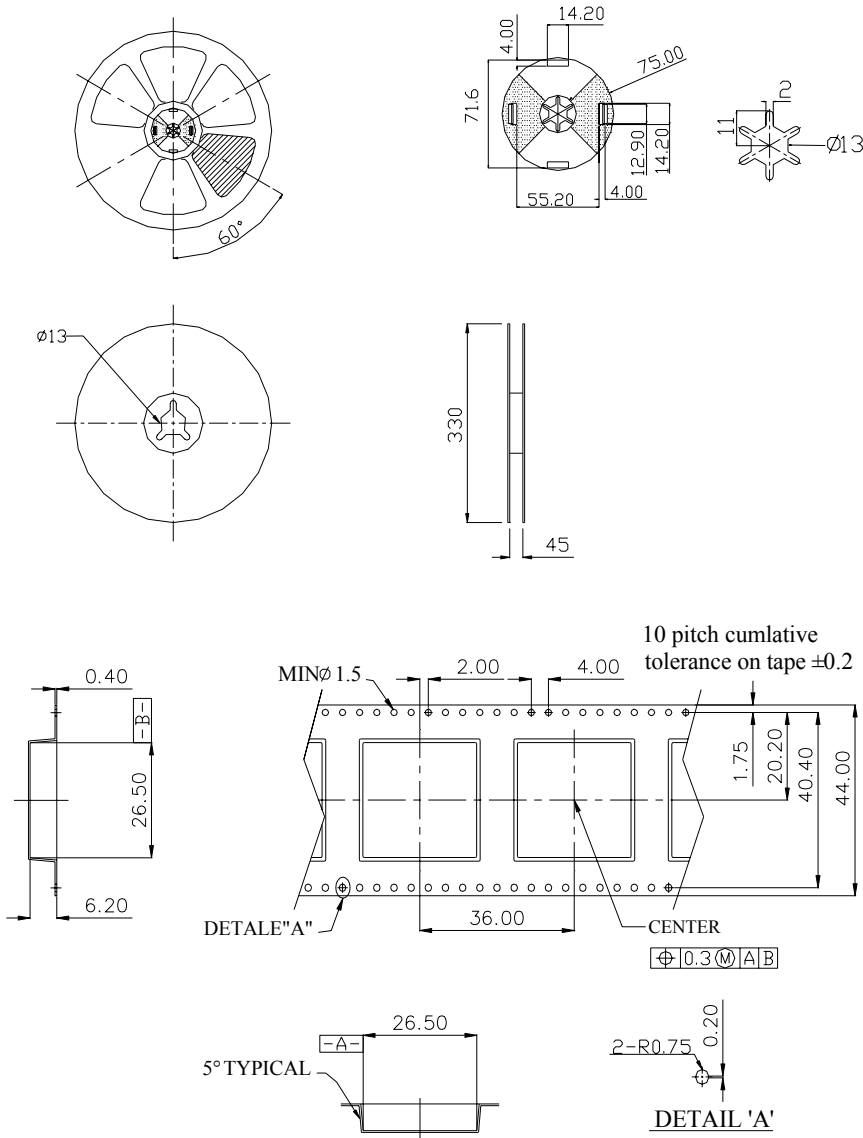

Note :

1. The number of loaded products in the reel is 100ea
2. All dimensions are in millimeters (tolerance :  $\pm 0.2$  )
3. Scale none

\*The appearance and specifications of the product may be changed for improvement without notice.



## Rectangular Type Reel Packaging - Star type

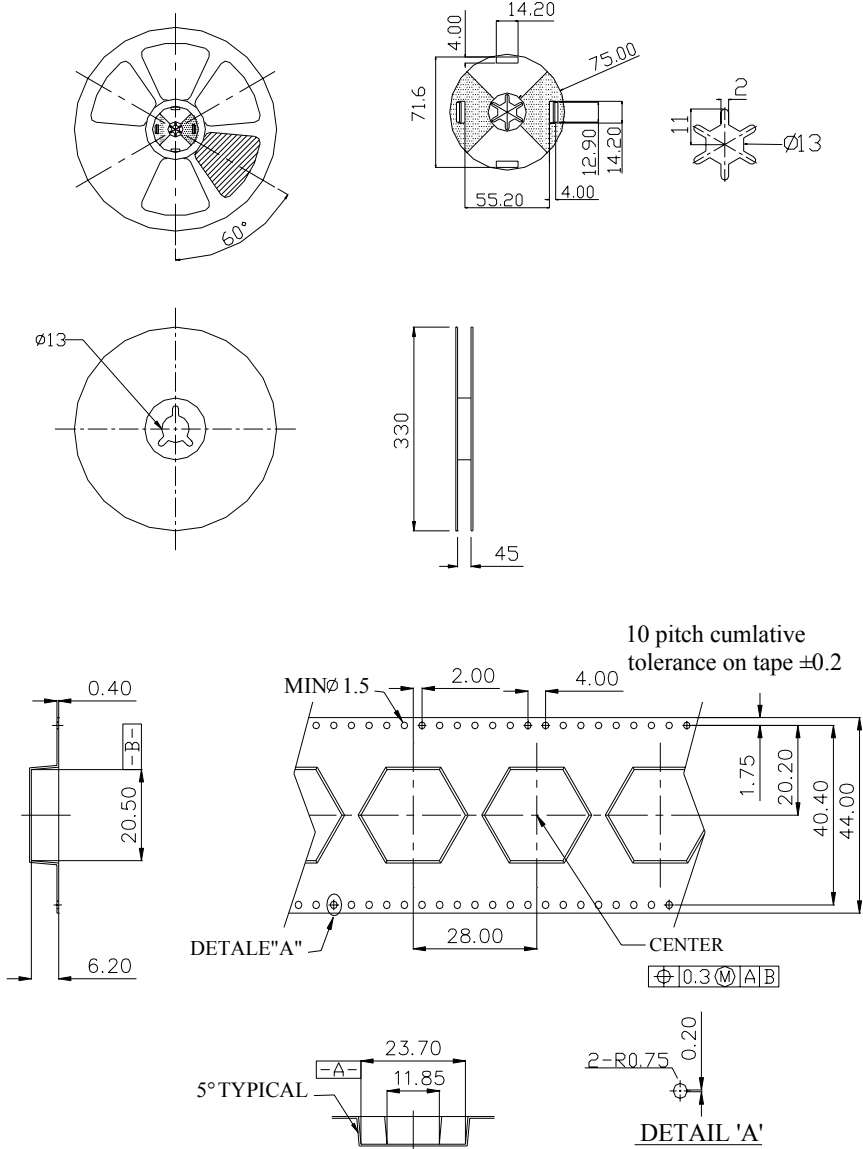

Note :

1. The number of loaded products in the reel is 100ea
2. All dimensions are in millimeters (tolerance :  $\pm 0.2$  )
3. Scale none

\*The appearance and specifications of the product may be changed for improvement without notice.

# Packaging Structure

## Aluminum Vinyl Bag

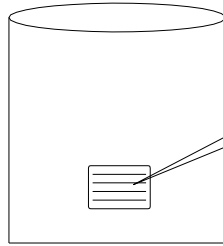

## Outer Box

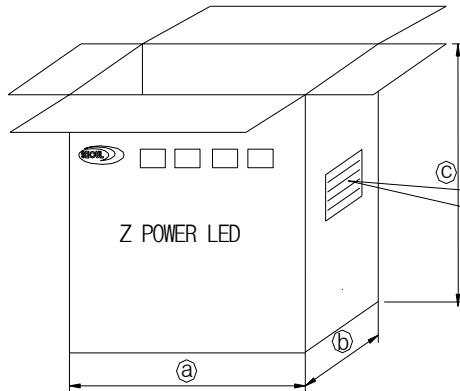

TYPE	SIZE(mm)		
	(a)	(b)	(c)
	350	350	370

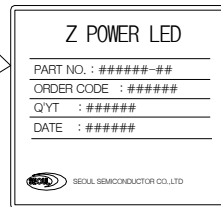

## Printed label on back of aluminum PCB

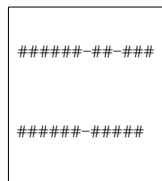

Part No. - Internal No. - Bin Code

Lot No.

Note :

1. 6 reels are loaded in box
2. Scale none
3. For more information about binning and labeling, refer to the Application Note - 1



## Precaution for use

- Storage

To avoid the moisture penetration, we recommend storing Z Power LEDs in a dry box (or desiccator) with a desiccant. The recommended storage conditions are Temperature 5 to 3 degrees Centigrade. Humidity 50% maximum.

- Precaution after opening packaging

However LED is correspond SMD, when LED be soldered dip, interfacial separation may affect the light transmission efficiency, causing the light intensity to drop.

Attention in followed.

- a. Soldering should be done right after opening the package(within 24Hrs).

- b. Keeping of a fraction

- Sealing

- Temperature : 5 ~ 40℃ Humidity : less than 30%

- c. If the package has been opened more than 1week or the color of desiccant changes, components should be dried for 10-12hr at 60±5℃

- Any mechanical force or any excess vibration shall not be accepted to apply during cooling process to normal temp. after soldering.

- Please avoid rapid cooling after soldering.

- Components should not be mounted on warped direction of PCB.

- Anti radioactive ray design is not considered for the products listed here in.

- Gallium arsenide is used in some of the products listed in this publication. These products are dangerous if they are burned or shredded in the process of disposal. It is also dangerous to drink the liquid or inhale the gas generated by such products when chemically disposed.

- This device should not be used in any type of fluid such as water, oil, organic solvent and etc. When washing is required, IPA(Isopropyl Alcohol) should be used.

- When the LEDs are illuminating, operating current should be decided after considering the package maximum temperature.

- LEDs must be stored to maintain a clean atmosphere. If the LEDs are stored for 3 months or more after being shipped from SSC, a sealed container with a nitrogen atmosphere should be used for storage.

- The appearance and specifications of the product may be modified for improvement without notice.

- Long time exposure of sunlight or occasional UV exposure will cause lens discoloration.

- The slug is connected to the anode. Therefore, we recommend to isolate the heat sink.



---

## Handling of Silicone resin LEDs

Z-Power LED is encapsulated by silicone resin for the highest flux efficiency.

Notes for handling of Silicone resin Z-Power LEDs

- Avoid touching silicone resin parts especially by sharp tools such as Tweezers
- Avoid leaving fingerprints on silicone resin parts.
- Please store the LEDs away from dusty areas or seal the product against dust.
- When populating boards in SMT production, there are basically no restrictions regarding the form of the pick and place nozzle, except that mechanical pressure on the surface of the resin must be prevented.
- Please do not mold over the silicone lens with another resin.  
(epoxy, urethane, etc)

