

Integrated Device Technology, Inc.

HIGH-SPEED BiCMOS
ECL STATIC RAM
4K (1K x 4-BIT) SRAM

PRELIMINARY
IDT10A474
IDT100A474
IDT101A474

FEATURES:

- 1024-words x 4-bit organization
- Address access time: 5/7/8/10/15 ns
- Low power dissipation: 600mW (typ.)
- Guaranteed Output Hold time
- Fully compatible with ECL logic levels
- Separate data input and output
- Center-power pin pinout for reduced noise
- Standard through-hole and surface mount packages

DESCRIPTION:

The IDT10A474, IDT100A474 and 101A474 are 4,096-bit high-speed BiCEMOS™ ECL static random access memories organized as 1Kx4, with separate data inputs and outputs. All I/Os are fully compatible with ECL levels.

These devices are part of a family of asynchronous four-bit-wide ECL SRAMs. This device have been configured to follow the center-power pinout for reduced noise allowing higher speed operation. Because they are manufactured in BiCEMOS™ technology, however, power dissipation is greatly reduced over equivalent bipolar devices.

The asynchronous SRAMs are the most straightforward to use because no additional clocks or controls are required: DataOUT is available an access time after the last change of address. To write data into the device requires the creation of a Write Pulse, and the write cycle disables the output pins in conventional fashion.

The fast access time and guaranteed Output Hold time allow greater margin for system timing variation. DataIN setup time specified with respect to the trailing edge of Write Pulse eases write timing allowing balanced Read and Write cycle times.

FUNCTIONAL BLOCK DIAGRAM

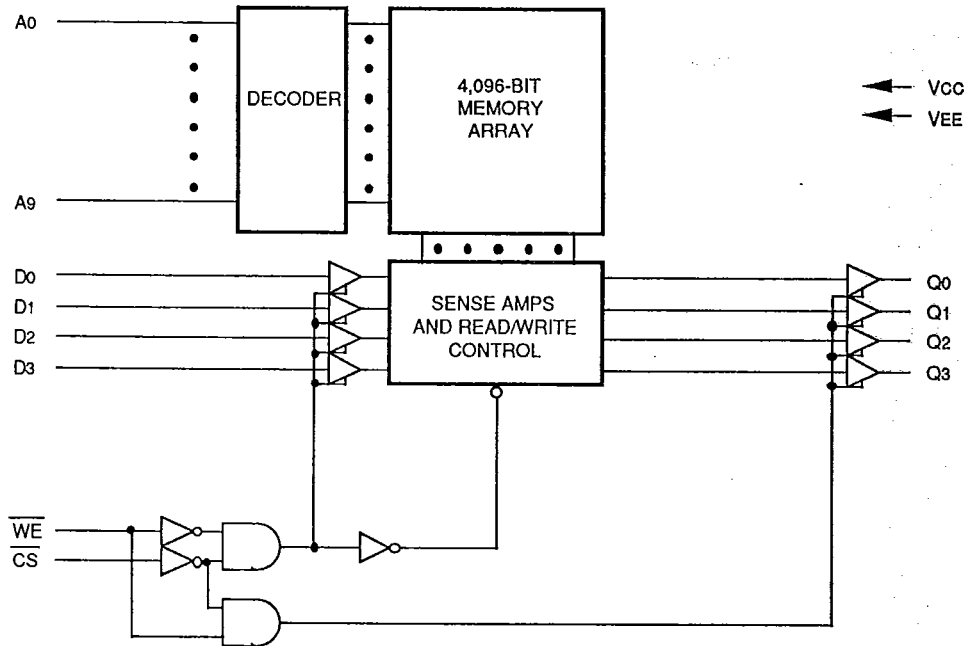

2760 drw 01

BiCEMOS is a trademark of Integrated Device Technology, Inc.

COMMERCIAL TEMPERATURE RANGE

MAY 1991

© 1991 Integrated Device Technology, Inc.

UPDATE 1 B

DSC-8021/-
67

IDT10A474, IDT100A474, IDT101A474
HIGH SPEED BICMOS ECL STATIC RAM 4K (1K x 4-BIT)

COMMERCIAL TEMPERATURE RANGE

PIN CONFIGURATION

T-46-23-08

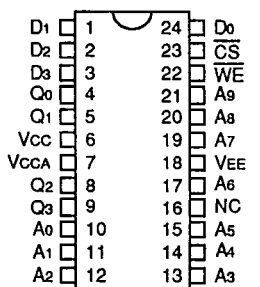

TOP VIEW 2760 drw 02

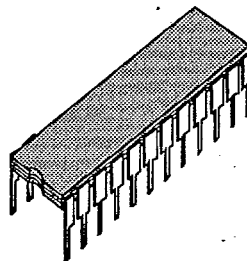

400-Mil-Wide
CERDIP PACKAGE
D24

PIN DESCRIPTIONS

Symbol	Pin Name
A0 through A9	Address Inputs
D0 through D3	Data Inputs
Q0 through Q3	Data Outputs
\overline{WE}	Write Enable
\overline{CS}	Chip Select Input (Internal pull down)
VEE	More Negative Supply Voltage
Vcc	Less Negative Supply Voltage

2760 tbl 01

LOGIC SYMBOL

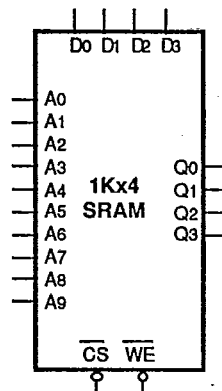

2760 drw 03

AC OPERATING RANGES⁽¹⁾

I/O	VEE	Temperature
10K	-5.2V ± 5%	0 to 75°C, air flow exceeding 2 m/sed
100K	-4.5V ± 5%	0 to 85°C, air flow exceeding 2 m/sed
101K	-4.75V ± -5.46V	0 to 75°C, air flow exceeding 2 m/sed

NOTE:
1. Referenced to Vcc.

2760 tbl 02

CAPACITANCE (TA=+25°C, f=1.0MHz)

Symbol	Parameter	DIP		Unit
		Typ.	Max.	
CIN	Input Capacitance	4	—	pF
COU	Output Capacitance	6	—	pF

2760 tbl 03

TRUTH TABLE⁽¹⁾

\overline{CS}	\overline{WE}	DATAOUT	FUNCTION
H	X	L	Deselcted
L	H	RAM Data	Read
L	L	L	Write

NOTE:
1. H=High, L=Low, X=Don't Care

2760 tbl 04

ECL-10K ABSOLUTE MAXIMUM RATINGS⁽¹⁾

T-46-23-08

Symbol	Rating	Value	Unit
VTERM	Terminal Voltage With Respect to GND	+0.5 to -7.0	V
TA	Operating Temperature	0 to +75	°C
TBIAS	Temperature Under Bias	-55 to +125	°C
TSTG	Storage Temperature	-65 to +150	°C
	Ceramic Plastic		
PT	Power Dissipation	1.5	W
IOUT	DC Output Current (Output High)	-50	mA

NOTE: 2760 tbl 05
1. Stresses greater than those listed under ABSOLUTE MAXIMUM RATINGS may cause permanent damage to the device. This is a stress rating only and functional operation of the device at these or any other conditions above those indicated in the operational sections of this specification is not implied. Exposure to absolute maximum rating conditions for extended periods may affect reliability.

ECL-10K DC ELECTRICAL CHARACTERISTICS

(V_{EE} = -5.2V, R_L = 50Ω to -2.0V, T_A = 0 to +75°C, air flow exceeding 2 m/sec)

Symbol	Parameter	Test Conditions	Min. (B)	Typ. ⁽¹⁾	Max. (A)	Unit	T _A
V _{OH}	Output HIGH Voltage	V _{IN} = V _{IHA} or V _{ILB}	-1000 -960 -900	-885	-840 -810 -720	mV	0°C 25°C 75°C
V _{OL}	Output LOW Voltage	V _{IN} = V _{IHA} or V _{ILB}	-1870 -1850 -1830	-	-1665 -1650 -1625	mV	0°C 25°C 75°C
V _{OHc}	Output Threshold HIGH Voltage	V _{IN} = V _{IHB} or V _{ILA}	-1020 -980 -920	-	-	mV	0°C 25°C 75°C
V _{OLc}	Output Threshold LOW Voltage	V _{IN} = V _{IHB} or V _{ILA}	-	-	-1645 -1630 -1605	mV	0°C 25°C 75°C
V _{IH}	Input HIGH Voltage	Guaranteed Input Voltage High for All Inputs	-1145 -1105 -1045	-	-840 -810 -720	mV	0°C 25°C 75°C
V _{IL}	Input LOW Voltage	Guaranteed Input Voltage Low for All Inputs	-1870 -1850 -1830	-	-1490 -1475 -1450	mV	0°C 25°C 75°C
I _{IH}	Input HIGH Current	V _{IN} = V _{IHA}	C _S	-	220	μA	-
			Others	-	110	μA	-
I _{IL}	Input LOW Current	V _{IN} = V _{ILB}	C _S	0.5	170	μA	-
			Others	-50	90	μA	-
I _{EE}	Supply Current	All Inputs and Outputs Open	-190	-130	-	mA	-

NOTE: 2760 tbl 06
1. Typical parameters are specified at V_{EE} = -5.2V, T_A = +25°C and maximum loading.



IDT10A474, IDT100A474, IDT101A474
HIGH SPEED BICMOS ECL STATIC RAM 4K (1K x 4-BIT)

COMMERCIAL TEMPERATURE RANGE

ECL-100K ABSOLUTE MAXIMUM RATINGS⁽¹⁾

Symbol	Rating	Value	Unit
VTERM	Terminal Voltage With Respect to GND	+0.5 to -7.0	V
TA	Operating Temperature	0 to +85	°C
TBIAS	Temperature Under Bias	-55 to +125	°C
TSTG	Storage Temperature	Ceramic	-65 to +150
		Plastic	-55 to +125
PT	Power Dissipation	1.5	W
IOUT	DC Output Current (Output High)	-50	mA

T-46-23-08

NOTE:

2760 tbi 07

1. Stresses greater than those listed under ABSOLUTE MAXIMUM RATINGS may cause permanent damage to the device. This is a stress rating only and functional operation of the device at these or any other conditions above those indicated in the operational sections of this specification is not implied. Exposure to absolute maximum rating conditions for extended periods may affect reliability.

ECL-100K DC ELECTRICAL CHARACTERISTICS

(V_{EE} = -4.5V, R_L = 50Ω to -2.0V, T_A = 0 to +85°C, air flow exceeding 2 m/sec)

Symbol	Parameter	Test Conditions	Min. (B)	Typ. ⁽¹⁾	Max. (A)	Unit
VOH	Output HIGH Voltage	V _{IN} = V _{IHA} or V _{ILB}	-1025	-955	-880	mV
VOL	Output LOW Voltage	V _{IN} = V _{IHA} or V _{ILB}	-1810	-1715	-1620	mV
VOHC	Output Threshold HIGH Voltage	V _{IN} = V _{IHB} or V _{ILA}	-1035	-	-	mV
VOLC	Output Threshold LOW Voltage	V _{IN} = V _{IHB} or V _{ILA}	-	-	-1610	mV
V _{IH}	Input HIGH Voltage	Guaranteed Input Voltage High for All Inputs	-1165	-	-880	mV
V _{IL}	Input LOW Voltage	Guaranteed Input Voltage Low for All Inputs	-1810	-	-1475	mV
I _{IH}	Input HIGH Current	V _{IN} = V _{IHA}	CS	-	220	μA
			Others	-	110	
I _{IL}	Input LOW Current	V _{IN} = V _{ILB}	CS	0.5	170	μA
			Others	-50	90	
I _{EE}	Supply Current	All Inputs and Outputs Open	-170	-110	-	mA

NOTE:

2760 tbi 08

1. Typical parameters are specified at V_{EE} = -4.5V, T_A = +25°C and maximum loading.

IDT10A474, IDT100A474, IDT101A474
HIGH SPEED BICMOS ECL STATIC RAM 4K (1K x 4-BIT)

COMMERCIAL TEMPERATURE RANGE

ECL-101K ABSOLUTE MAXIMUM RATINGS⁽¹⁾

T-46-23-08

Symbol	Rating	Value	Unit
VTERM	Terminal Voltage With Respect to GND	+0.5 to -7.0	V
TA	Operating Temperature	0 to +75	°C
TBIAS	Temperature Under Bias	-55 to +125	°C
TSTG	Storage Temperature	-65 to +150	°C
	Ceramic Plastic	-55 to +125	
PT	Power Dissipation	1.5	W
IOUT	DC Output Current (Output High)	-50	mA

NOTE: 2760 tbl 09
1. Stresses greater than those listed under ABSOLUTE MAXIMUM RATINGS may cause permanent damage to the device. This is a stress rating only and functional operation of the device at these or any other conditions above those indicated in the operational sections of this specification is not implied. Exposure to absolute maximum rating conditions for extended periods may affect reliability.

ECL-101K DC ELECTRICAL CHARACTERISTICS

(VEE = -5.2V, RL = 50Ω to -2.0V, TA = 0 to +75°C, air flow exceeding 2 m/sec)

Symbol	Parameter	Test Condition	Min. (B)	Typ. ⁽¹⁾	Max. (A)	Unit
VOH	Output HIGH Voltage	V _{IN} = V _{IHA} or V _{ILB}	-1025	-955	-880	mV
VOL	Output LOW Voltage	V _{IN} = V _{IHA} or V _{ILB}	-1810	-1715	-1620	mV
VOHC	Output Threshold HIGH Voltage	V _{IN} = V _{IHB} or V _{ILA}	-1035	-	-	mV
VOLC	Output Threshold LOW Voltage	V _{IN} = V _{IHB} or V _{ILA}	-	-	-1610	mV
VIH	Input HIGH Voltage	Guaranteed Input Voltage High for All Inputs	-1165	-	-880	mV
VIL	Input LOW Voltage	Guaranteed Input Voltage Low for All Inputs	-1810	-	-1475	mV
I _{IH}	Input HIGH Current	V _{IN} = V _{IHA}	CS	-	220	μA
		Others		-	110	
I _{IL}	Input LOW Current	V _{IN} = V _{ILB}	CS	0.5	170	μA
		Others		-50	90	
IEE	Supply Current	All Inputs and Outputs Open	-190	-130	-	mA

2760 tbl 10



IDT10A474, IDT100A474, IDT101A474
HIGH SPEED BICMOS ECL STATIC RAM 4K (1K x 4-BIT)

COMMERCIAL TEMPERATURE RANGE

AC TEST LOAD CONDITION

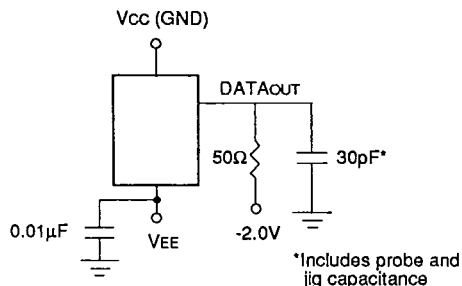

AC TEST INPUT PULSE

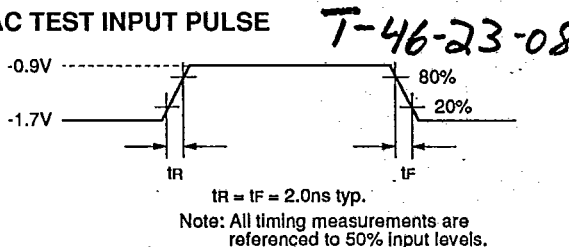

RISE/FALL TIME

Symbol	Parameter	Test Condition	Min.	Typ.	Max.	Unit
tR	Output Rise Time	-	-	2	-	ns
tF	Output Fall Time	-	-	2	-	ns

2760 tbi 11

FUNCTIONAL DESCRIPTION

The IDT10A474, IDT100A474, and IDT101A474 BICMOS ECL static RAMs (SRAM) provide high speed with low power dissipation typical of BICMOS ECL. These devices follow the center-power pinout and functionality for 1Kx4 ECL SRAMs, reducing noise over corner-power versions allowing for improved system performance. (For corner-power pinouts, please see the IDT10474, IDT100474, and IDT101474, respectively.)

READ TIMING

The read timing on these asynchronous devices is straightforward. DataOUT is held low until the device is selected by Chip Select (\overline{CS}). Then Address (ADDR) settles and data appears on the output after time tAA. Note that DataOUT is held for a short time (tOH) after the address begins to change for the next access, then ambiguous data is on the bus until a new time tAA.

WRITE TIMING

To write data to the device, a Write Pulse need be formed on the Write Enable input (\overline{WE}) to control the write to the SRAM array. While \overline{CS} and ADDR must be set-up when \overline{WE} goes low, DataIN can settle after the falling edge of \overline{WE} , giving the data path extra margin. Data is written to the memory cell at the end of the Write Pulse, and addresses and Chip Select must be held after the rising edge of the Write Pulse to ensure satisfactory completion of the cycle.

DataOUT is disabled (held low) during the Write Cycle. If \overline{CS} is held low (active) and addresses remain unchanged, the DataOUT pins will output the written data after "Write Recovery Time" (tWR).

Because of the very short Write Pulse requirement, these devices can be cycled as quickly for Writes as for Reads. Balanced cycles mean simpler timing in cache applications.

IDT10A474, IDT100A474, IDT101A474
HIGH SPEED BICMOS ECL STATIC RAM 4K (1K x 4-BIT)

COMMERCIAL TEMPERATURE RANGE

AC ELECTRICAL CHARACTERISTICS (Over the AC Operating Range)

T-46-23-08

Symbol	Parameter ⁽¹⁾	Test Condition	10A474S5		10A474S7		10A474S8		10A474S10		10A474S15		Unit
			Min.	Max.	Min.	Max.	Min.	Max.	Min.	Max.	Min.	Max.	
Read Cycle													
tACS	Chip Select Access Time	-	-	2.5	-	3	-	5	-	5	-	5	ns
tRCS	Chip Select Recovery Time	-	-	5	-	3	-	5	-	5	-	5	ns
tAA	Address Access Time	-	-	5	-	7	-	8	-	10	-	15	ns
tOH	Data Hold from Address Change	-	2	-	3	-	3	-	3	-	3	-	ns

NOTE:
1. Input and Output reference level is 50% point of waveform.

2760 tbl 12

READ CYCLE GATED BY CHIP SELECT

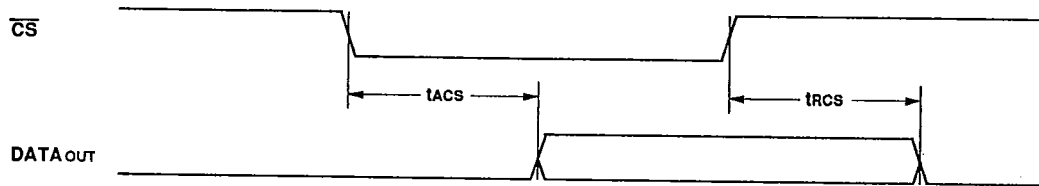

READ CYCLE GATED BY ADDRESS

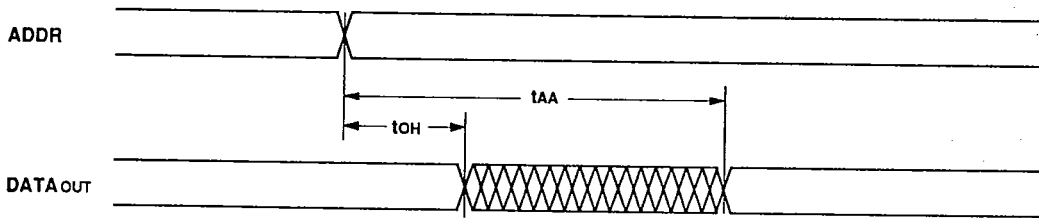

2760 drw 04



T-46-23-08

IDT10A474, IDT100A474, IDT101A474
HIGH SPEED BICMOS ECL STATIC RAM 4K (1K x 4-BIT)

COMMERCIAL TEMPERATURE RANGE

AC ELECTRICAL CHARACTERISTICS (Over the AC Operating Range)

Symbol	Parameter ⁽¹⁾	Test Condition	10A474S5 100A474S5 101A474S5		10A474S7 100A474S7 101A474S7		10A474S8 100A474S8 101A474S8		10A474S10 100A474S10 101A474S10		10A474S15 100A474S15 101A474S15		Unit
			Min.	Max.	Min.	Max.	Min.	Max.	Min.	Max.	Min.	Max.	
Write Cycle													
t _w	Write Pulse Width	t _{WSA} = minimum	4	-	6	-	7	-	8	-	10	-	ns
t _{WSD}	Data Set-up Time	-	0	-	0	-	0	-	0	-	2	-	ns
t _{WSD2} ⁽²⁾	Data Set-up Time to \overline{WE} High	-	3	-	5	-	5	-	5	-	5	-	ns
t _{WSA}	Address Set-up Time	t _{WSA} = minimum	0	-	0	-	0	-	0	-	2	-	ns
t _{WSCS}	Chip Select Set-up Time	-	0	-	0	-	0	-	0	-	2	-	ns
t _{WHD}	Data Hold Time	-	1	-	1	-	1	-	1	-	2	-	ns
t _{WHA}	Address Hold Time	-	1	-	1	-	1	-	1	-	2	-	ns
t _{WHCS}	Chip Select Hold Time	-	1	-	1	-	1	-	1	-	2	-	ns
t _{WS}	Write Disable Time	-	-	3	-	5	-	5	-	5	-	5	ns
t _{WR} ⁽³⁾	Write Recovery Time	-	-	3	-	5	-	5	-	5	-	5	ns

2760 1b1 13

NOTES:

1. Input and Output reference level is 50% point of waveform.
2. t_{WSD} is specified with respect to the falling edge of \overline{WE} for compatibility with bipolar part specifications, but this device actually only requires t_{WSD2} with respect to rising edge of \overline{WE} .
3. t_{WR} is defined as the time to reflect the newly written data on the Data Outputs (Q₀ to Q₃) when no new Address Transition occurs.

WRITE CYCLE TIMING DIAGRAM

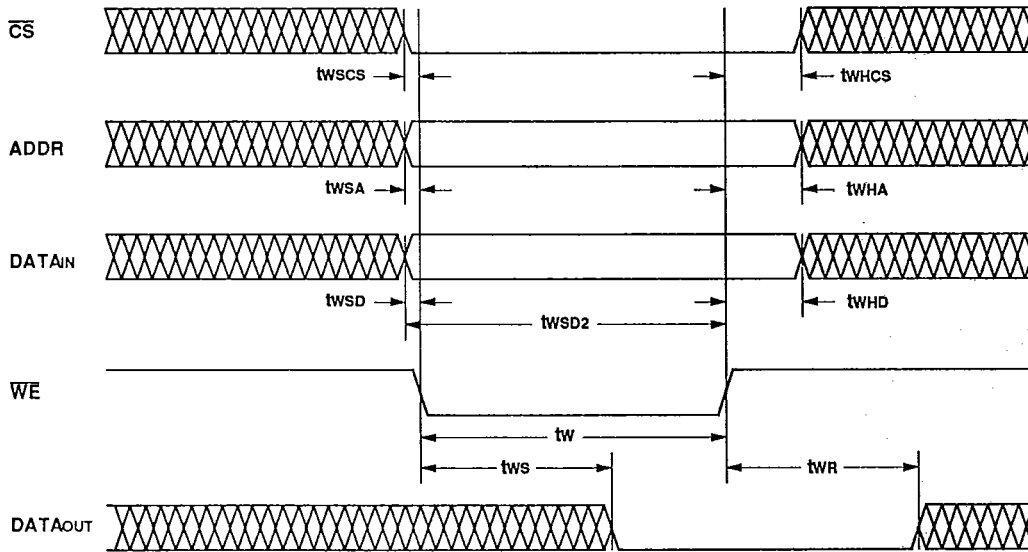

2760 drw 05

IDT10A474, IDT100A474, IDT101A474
 HIGH SPEED BICMOS ECL STATIC RAM 4K (1K x 4-BIT)

COMMERCIAL TEMPERATURE RANGE

ORDERING INFORMATION

T-46-23-08

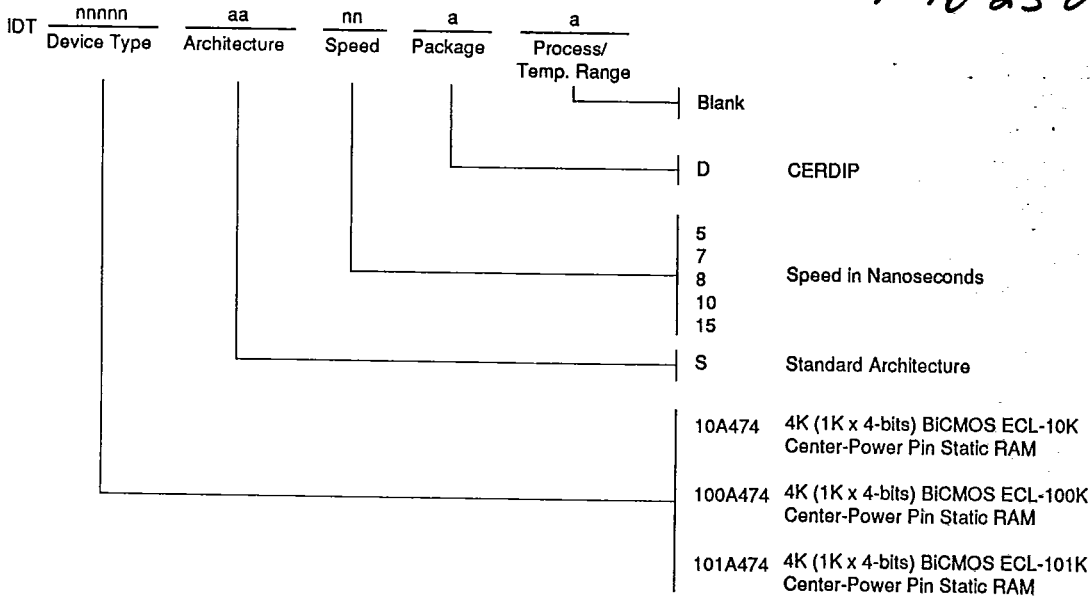

2760 drw 06

