

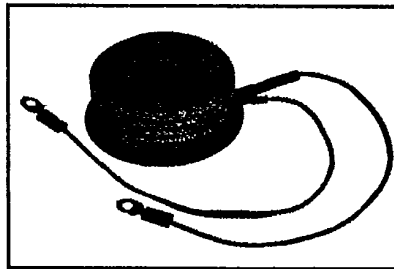

T820

Powerex, Inc. Hillis Street, Youngwood, Pennsylvania 15697 (412) 925-7272
 Powerex Europe, S.A., 428 Ave. G. Durand, BP107, 72003 LeMans, France (43) 72.75.15

Phase Control SCR
750-900 Amperes Avg
100-2200 Volts

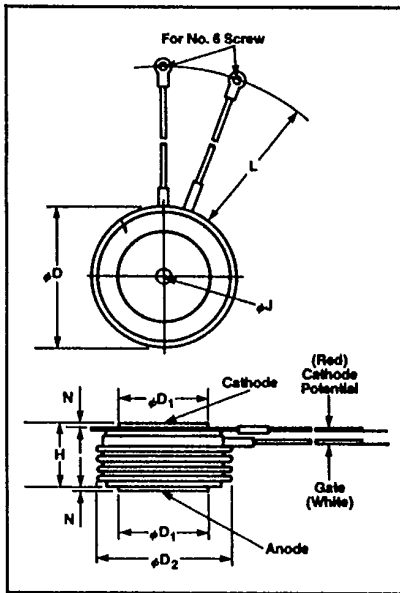

T820
Phase Control SCR
 750-900 Amperes/100-2200 Volts

Description

Powerex Silicon Controlled Rectifiers (SCR) are designed for phase control applications. These are all-diffused, Press-Pak (Pow-R-Disc) devices employing the field-proven amplifying (di/namic) gate.

Features:

- Low On-State Voltage
- High di/dt
- High dv/dt
- Hermetic Packaging
- Excellent Surge and I²t Ratings

Applications:

- Power Supplies
- Battery Chargers
- Motor Control
- Light Dimmers
- VAR Generators

Ordering Information

Example: Select the complete eight digit part number you desire from the table - i.e. T8200875 is a 800 Volt, 750 Ampere Phase Control SCR.

T82
Outline Drawing

Dimensions	Inches		Millimeters	
	Min.	Max.	Min.	Max.
φD	2.250	2.290	57.15	58.17
φD ₁	1.333	1.343	33.86	34.11
φD ₂	2.030	2.090	51.56	53.09
H	1.020	1.060	25.91	26.92
φJ	.135	.145	3.43	3.68
L	11.50	12.50	292.10	317.50
N	.040	—	1.02	—

Creep Distance—1.00 in. min. (25.40 mm)
 Strike Distance—.69 in. min. (17.53 mm).
 (In accordance with NEMA standards.)
 Finish—Nickel Plate.
 Approx. Weight—8 oz. (227 g).
 1. Dimension "H" is clamped dimension.

Type	Voltage*		Current	
	V _{ORM} V _{RRM}	Code	I _r (avg)	Code
T820	100	01	750	75
	200	02	900	90
	400	04		
	600	06		
	800	08		
	1000	10		
	1200	12		
	1300	13		
	1400	14		
	1500	15		
	1600	16		
	2000	20		
2200	22			

*All voltages not available in all current ratings.



Powerex, Inc., Hillis Street, Youngwood, Pennsylvania 15697 (412) 925-7272

Powerex Europe, S.A., 428 Ave. G. Durand, BP107, 72003 LeMans, France (43) 72.75.15

T820

Phase Control SCR

750-900 Amperes Avg/100-2200 Volts

Absolute Maximum Ratings

	Symbol	T820 _ _ 75	T820 _ _ 90	Units
Maximum Blocking Voltage	V_{DRM}, V_{RRM}	2200	1400	Volts
RMS On-State Current	$I_{T(RMS)}$	1175	1410	Amperes
Average On-State Current	$I_{T(av)}$	750	900	Amperes
Peak One-Cycle Surge (Non-Repetitive) On-State Current (60Hz) [Ⓞ]	I_{TSM}	12,000	15,000	Amperes
Peak One-Cycle Surge (Non-Repetitive) On-State Current (50Hz) [Ⓞ]	I_{TSM}	10,950	13,700	Amperes
Critical Rate-of-Rise of On-State Current (Non-Repetitive) ^{ⓄⓄⓄ}	di/dt	400	400	Amperes/ μ s
Critical Rate-of-Rise of On-State Current (Repetitive)	di/dt	150	150	Amperes/ μ s
I^2t (for Fusing), One Cycle at 60Hz	I^2t	600,000	935,000	A ² sec
Peak Gate Power Dissipation	P_{GM}	16	16	Watts
Average Gate Power Dissipation	$P_{G(av)}$	3	3	Watts
Storage Temperature	T_{STG}	-40 to 150	-40 to 150	°C
Operating Temperature	T_J	-40 to 125	-40 to 125	°C
Mounting Force [Ⓞ]		3000 to 3500	3000 to 3500	lb.
Mounting Force [Ⓞ]		1360 to 1590	1360 to 1590	kg

Electrical and Thermal Characteristics

	Symbol	Test Conditions	T820 _ _ 75	T820 _ _ 90	Units
Current—Conducting State Maximums					
Peak On-State Voltage	V_{TM}	$I_{TM} = 1500A, T_J = 25^\circ C$	1.65	1.35	Volts
T820					
Voltage—Blocking State Maximums[Ⓞ]					
Forward Leakage, Peak	I_{DRM}	$T_J = 125^\circ C, V_{DRM} = \text{rated}$	35		mA
Reverse Leakage, Peak	I_{RRM}	$T_J = 125^\circ C, V_{RRM} = \text{rated}$	35		mA
Switching					
Typical Turn-Off Time	t_q	$I_T = 250A, T_J = 125^\circ C,$ $di_R/dt = 50A/\mu\text{sec}, \text{reapplied}$ $dv/dt = 20V/\mu\text{sec linear to } 0.8V_{DRM}$	200		μsec
Typical Turn-On Time [Ⓞ]	t_{on}	$I_{TM} = 1000A, V_D = 600V$	5.0		μsec
Min. Critical dv/dt exponential to V_{DRM} ^{ⓄⓄ}	dv/dt	$T_J = 125^\circ C$	300		V/ μsec
Thermal					
Maximum Thermal Resistance, [Ⓞ] double sided cooling					
Junction to Case	$R_{\theta JC}$.037		°C/Watt
Case to Sink, Lubricated	$R_{\theta CS}$.020		°C/Watt
Gate—Maximum Parameters					
Gate Current to Trigger	I_{GT}	$T_J = 25^\circ C, V_D = 12V$	150		mA
Gate Voltage to Trigger	V_{GT}	$T_J = 25^\circ C, V_D = 12V$	3.0		Volts
Non-Triggering Gate Voltage	V_{GDM}	$T_J = 125^\circ C, \text{rated } V_{DRM}$.15		Volts
Peak Forward Gate Current	I_{GTM}		4		Amperes
Peak Reverse Gate Voltage	V_{GRM}		5		Volts

[Ⓞ] Consult recommended mounting procedures.

[Ⓞ] Applies for zero or negative gate bias.

[Ⓞ] Per JEDEC RS-397, 5.2.2.1.

[Ⓞ] With recommended gate drive.

[Ⓞ] Higher dv/dt ratings available, consult factory.

[Ⓞ] Per JEDEC standard RS-397, 5.2.2.6.



Powerex, Inc., Hillis Street, Youngwood, Pennsylvania 15697 (412) 925-7272
 Powerex Europe, S.A., 428 Ave. G. Durand, BP107, 72003 LeMans, France (43) 72.75.15

T820
 Phase Control SCR
 750-900 Amperes Avg/100-2200 Volts

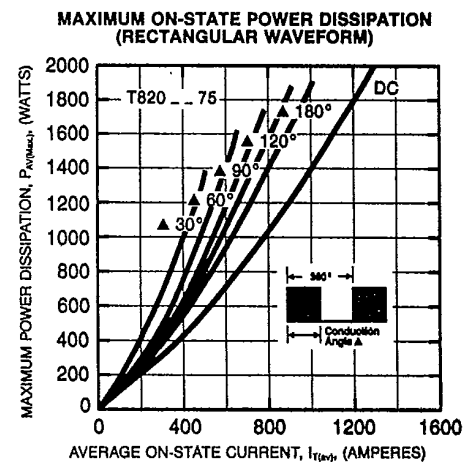
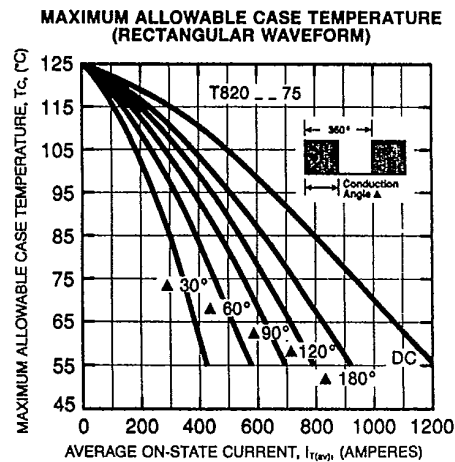
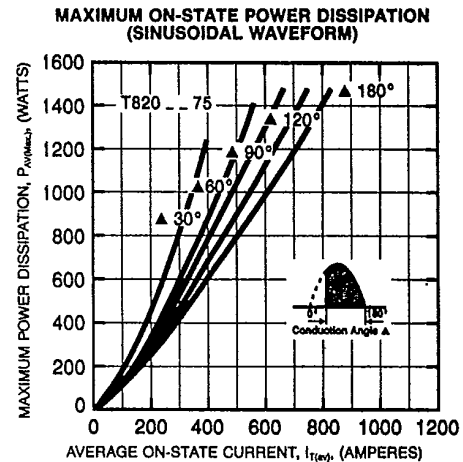
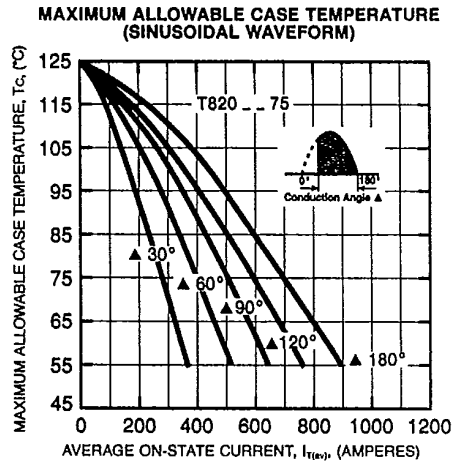
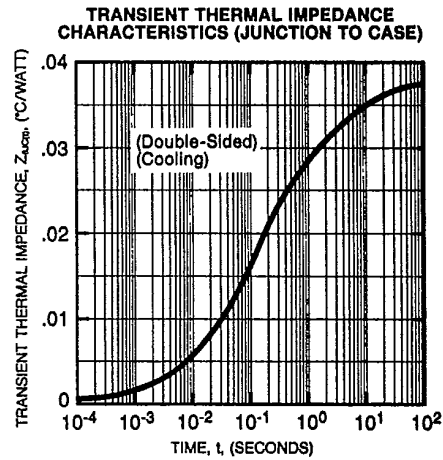
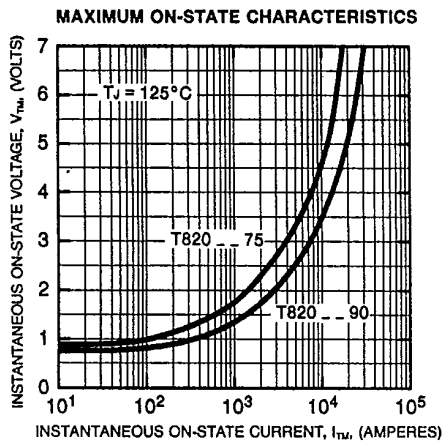



Powerex, Inc., Hillis Street, Youngwood, Pennsylvania 15697 (412) 925-7272
 Powerex Europe, S.A., 428 Ave. G. Durand, BP107, 72003 LeMans, France (43) 72.75.15

T820
 Phase Control SCR
 750-900 Amperes Avg/100-2200 Volts

