

ANSALDO**Ansaldo Trasporti s.p.a.
Unita' Semiconduttori**Via N. Lorenzi 8 - I 16152 GENOVA - ITALY
Tel. int. +39/(0)10 6556549 - (0)10 6556488
Fax Int. +39/(0)10 6442510
Tx 270318 ANSUSE I -**FAST RECOVERY DIODE****ARF340**

Repetitive voltage up to	2600 V
Mean forward current	775 A
Surge current	6.4 kA

FINAL SPECIFICATION

lug 98 - ISSUE : 01

Symbol	Characteristic	Conditions	T _j [°C]	Value	Unit
BLOCKING					
V _{RRM}	Repetitive peak reverse voltage		150	2600	V
V _{RSM}	Non-repetitive peak reverse voltage		150	2700	V
I _{RRM}	Repetitive peak reverse current	V=VRRM	150	50	mA
CONDUCTING					
I _{F(AV)}	Mean forward current	180° sin ,50 Hz, Th=55°C, double side cooled		775	A
I _{F(AV)}	Mean forward current	180° square,50 Hz,Th=55°C,double side cooled		780	A
I _{FSM}	Surge forward current	Sine wave, 10 ms reapplied reverse voltage up to 50% VRSM	150	6,4	kA
I ² t	I ² t			205 x1E3	A ² s
V _{FM}	Forward voltage	Forward current : 1200 A	25	2,3	V
V _{F(TO)}	Threshold voltage		150	1,15	V
r _F	Forward slope resistance		150	0,685	mohm
SWITCHING					
t _{rr}	Reverse recovery time	I _F = 350 A di/dt= 80 A/μs VR = 100 V	150	4	μs
Q _{rr}	Reverse recovery charge			260	μC
I _{rr}	Peak reverse recovery current			140	A
s	Softness (s-factor), min			0,4	
V _{FR}	Peak forward recovery	di/dt= 400 A/μs	150	20	V
MOUNTING					
R _{th(j-h)}	Thermal impedance	Junction to heatsink, double side cooled		50	°C/kW
T _j	Operating junction temperature			-30 / 150	°C
F	Mounting force			8.0 / 9.0	kN
	Mass			85	g
ORDERING INFORMATION : ARF340 S 26					
standard specification _____ _____ VRRM/100					

FORWARD CHARACTERISTIC
T_j = 150 °C

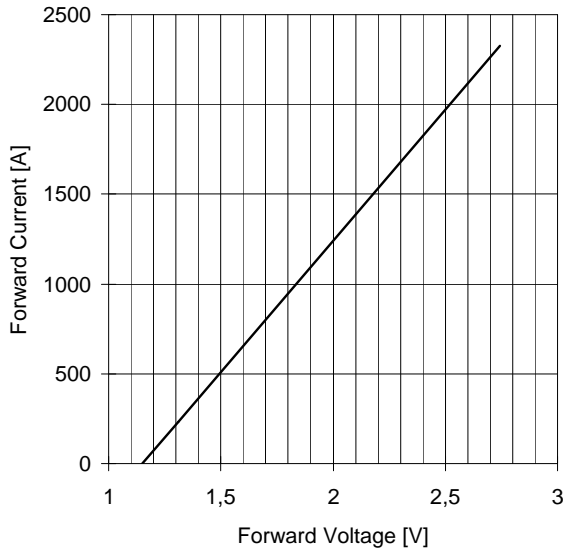

SURGE CHARACTERISTIC
T_j = 150 °C

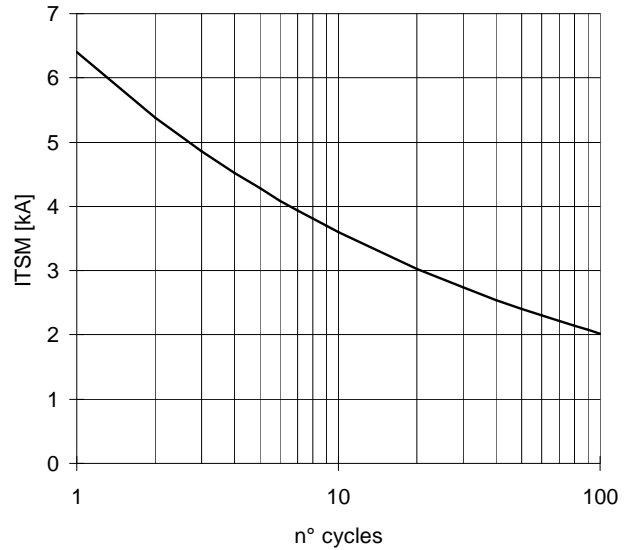

TRANSIENT THERMAL IMPEDANCE
DOUBLE SIDE COOLED

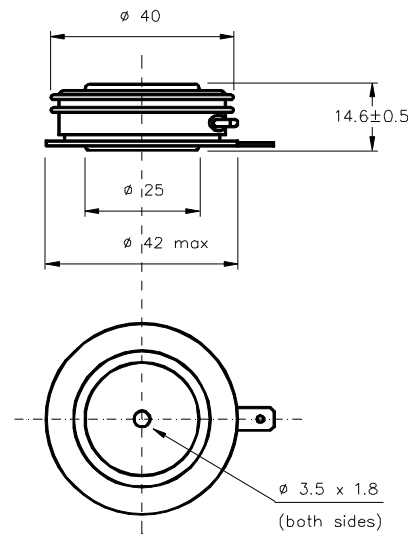
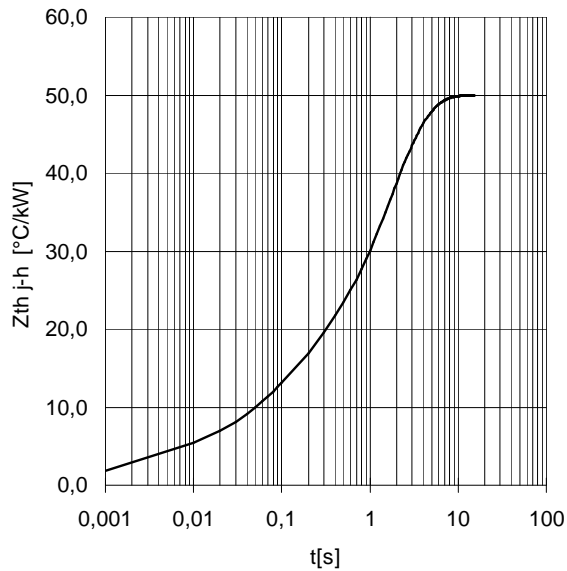

Dimensions
in mm



All the characteristics given in this data sheet are guaranteed only with uniform clamping force, cleaned and lubricated heatsink, surfaces with flatness < .03 mm and roughness < 2 μm.

In the interest of product improvement ANSALDO reserves the right to change any data given in this data sheet at any time without previous notice.

If not stated otherwise the maximum value of ratings (symbols over shaded background) and characteristics is reported.

Distributed by

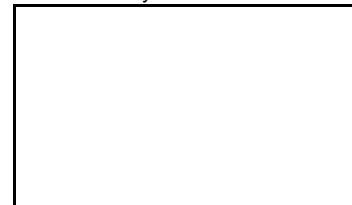

DISSIPATION CHARACTERISTICS

SQUARE WAVE

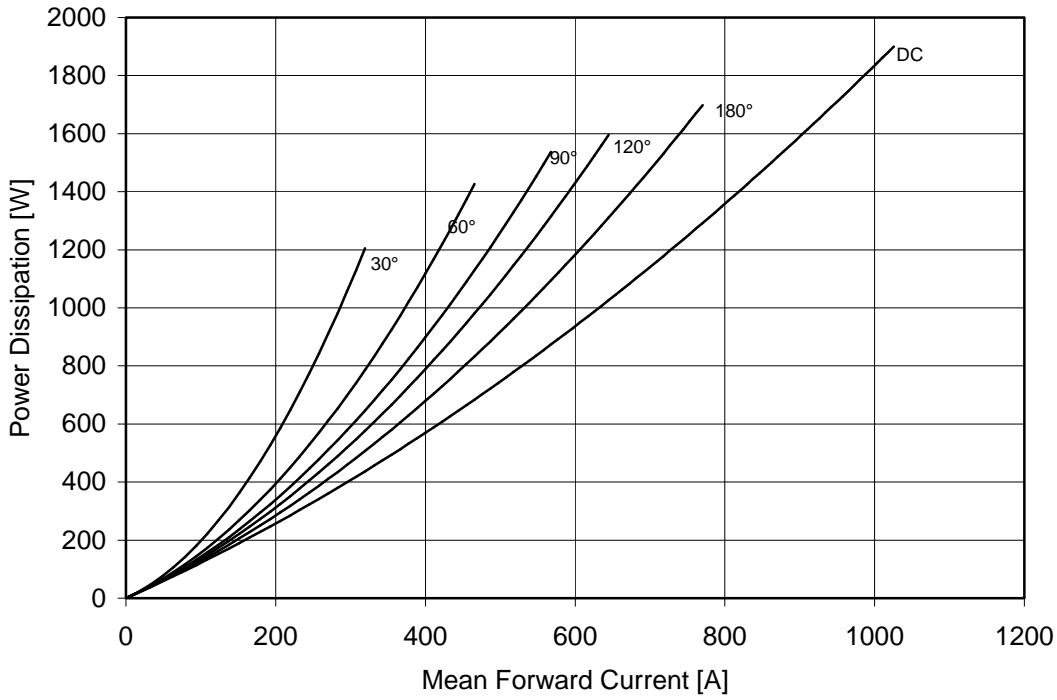

SINE WAVE

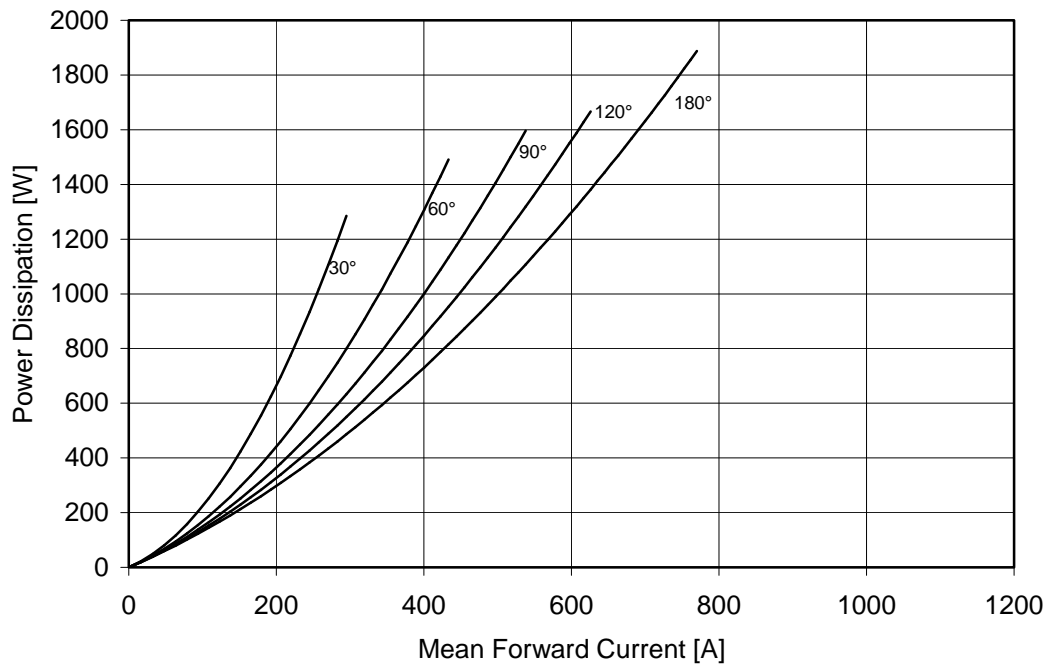

SWITCHING CHARACTERISTICS

FORWARD RECOVERY VOLTAGE

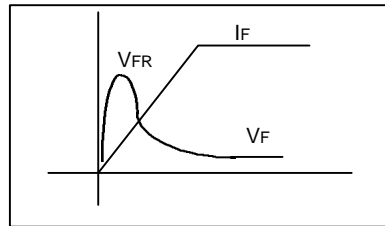
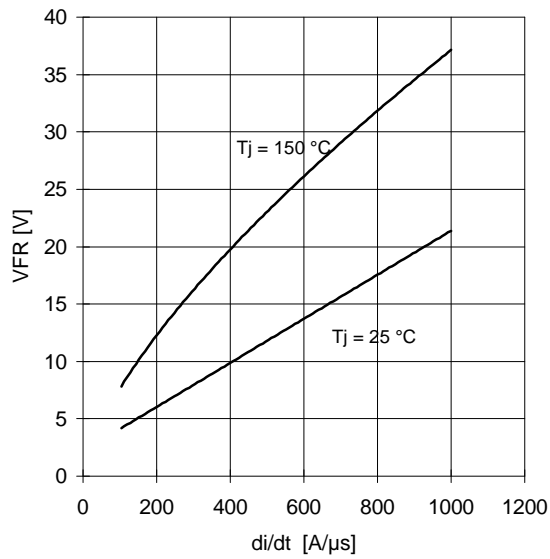

REVERSE RECOVERY CHARGE
Tj = 150 °C

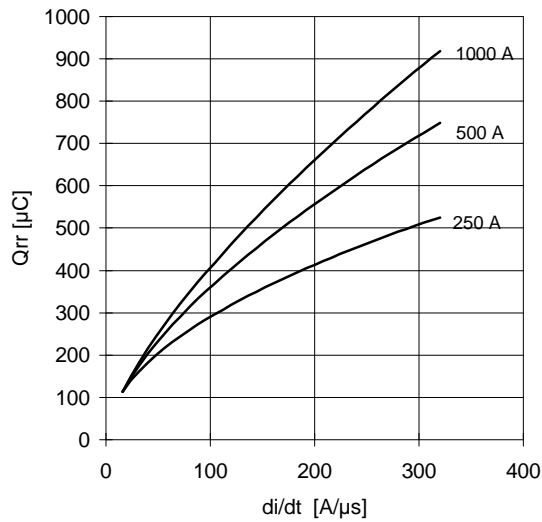

REVERSE RECOVERY CURRENT
Tj = 150 °C

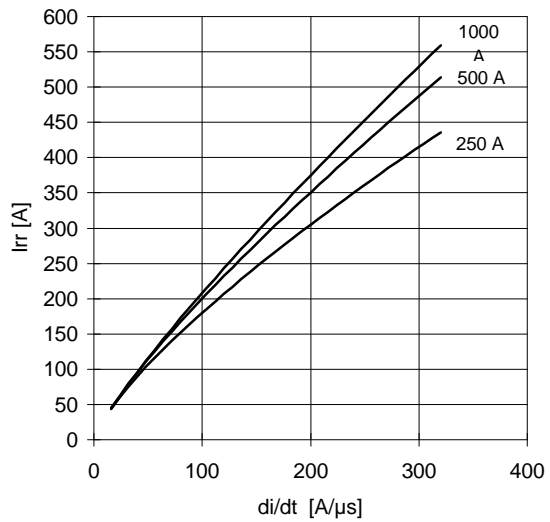

$$t_a = I_{rr} / (di/dt) \quad t_b = t_{rr} - t_a$$

Softness (s factor) $s = t_b / t_a$

Energy dissipation during recovery $E_r = V_r (Q_{rr} - I_{rr} t_a /$

