

PRELIMINARY

S1117

1.0A Adjustable LDO Linear Regulator

Features

- ◆ adjustable version.
- ◆ Space saving SMD types of SOT-223 and D-Pak(TO-252)
- ◆ 1.1V Drop-out Voltage
- ◆ 1.0A Output Current
- ◆ Current Limiting and Thermal protection
- ◆ Over Current Protection.
- ◆ Output trimmed to 2% Tolerance
- ◆ Fast Transient Response

General Description

The S1117 is a series of low dropout voltage regulators which can provide up to 1A of output current. On chip precision trimming adjusts the reference/output voltage to within $\pm 2\%$. Current limit is also trimmed to ensure specified output current and controlled short-circuit current. The S1117 series is available in SOT-223 and DPAK power packages. A minimum of 10uF tantalum capacitor is required at the output to improve the transient response and stability.

Applications

- ◆ Post Regulator for Switching DC/DC Converter
- ◆ High Efficiency Linear Regulator
- ◆ Battery Chargers
- ◆ PC Add on Card
- ◆ Motherboard clock supplies

Absolute Maximum Ratings

Parameter	Symbol	Value	Units
Input Voltage	$V_{IN(MAX)}$	18	V
Junction Temperature	T_J	-25°C ~ +125°C	°C
Storage Temperature	T_{STG}	-55°C ~ +150°C	°C

Electrical Characteristics

($V_{in} = 3.25V$, $C_o = 10\mu F$, $T_a = 25^\circ C$, unless otherwise specified)

Parameter	Symbol	Test Condition	Min.	Typ.	Max.	Units
Reference Voltage	V_{ref}	$V_{IN} = 3.25V, I_O = 10mA$	1.225	1.250	1.275	V
Line Regulation	dV_{OUT1}	$I_{OUT}=10mA, 3.25V < V_{IN} < 12.25V$	0	1.0	2.5	mV
Load Regulation	dV_{OUT2}	$V_{IN} = 3.25V, 10mA < I_{OUT} < 1A$	0	1.0	6.0	mV
Dropout Voltage 1	V_{DRO1}	$I_{OUT} = 100mA$	-	1.00	1.15	V
Dropout Voltage 2	V_{DRO2}	$I_{OUT} = 1A$	-	1.10	1.25	V
Quiescent Current	I_q	$V_{IN} < 12V$	-	5	10	mA
Ripple Rejection	RR	$f = 120Hz, C_{OUT} = 22\mu F$ Tantalum, $4.15V < V_{IN} < 4.35, I_{OUT} = 500mA$	55	100	200	dB

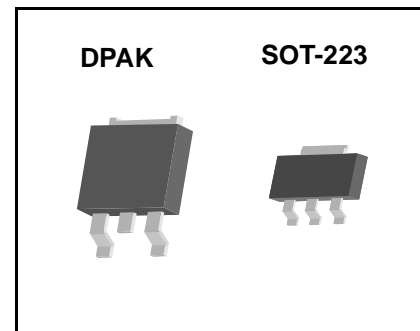
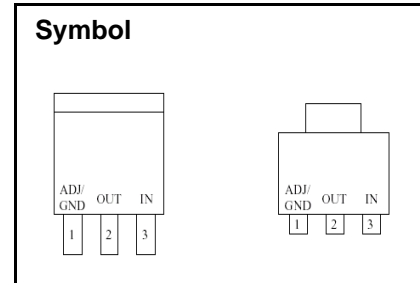

S1117

Electrical Characteristics

($V_{in} = 3.25V$, $C_o = 10\mu F$, $T_a = 25^\circ C$, unless otherwise specified)

Parameter	Symbol	Test Condition	Min.	Typ.	Max.	Units
Current Limit	I_{Limit}	$V_{IN} - V_{OUT} = 2V$	1	1.5	-	A
Adjust Pin Current	I_{adj}	$V_{in} = 3.25V$, $I_o = 10mA$	10	35	100	μA
Minimum Load Current	I_{Min}		10	-	-	mA
Long Term Stability	Stable	$T_A = 125^\circ C$, 1000hrs	-	0.03	1.0	%
RMS Output Noise		$10Hz < f < 10kHz$	-	0.003	-	%
Thermal Shutdown	T_{sd}	$V_{in} = 3.25V$ $T_j = 130$ to $210deg$	150	170	200	$^\circ C$
Thermal Shutdown Hysteresis	T_{hys}	$V_{in} = 3.25V$ $T_j = 210$ to $130deg$	5	10	35	$^\circ C$
Over Voltage Protection	V_{OVP}	$V_{in} = 10V$ to $25V$ $I_o = 10mA$	14.4	16.4	18.4	V

Fig 1. Output current vs. drop out voltage

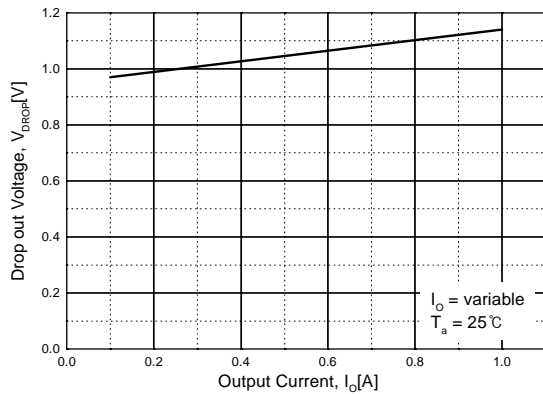

Fig 2. Quiescent current vs. drop out voltage

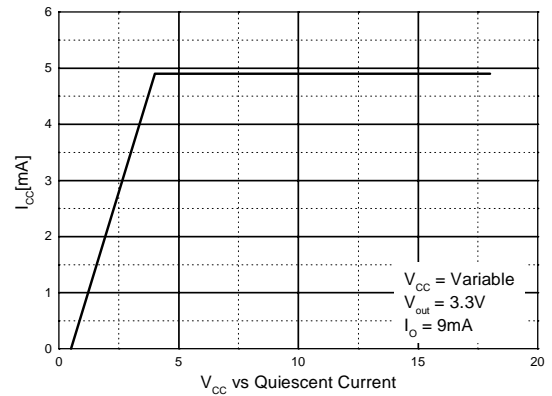

Fig 3. Output current vs. load regulation

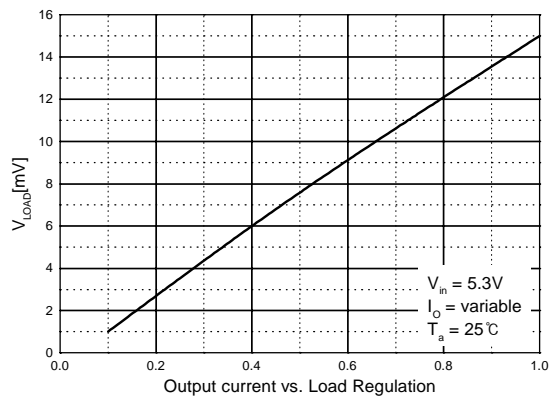

Fig 4. Absolute Maximum safe operating area

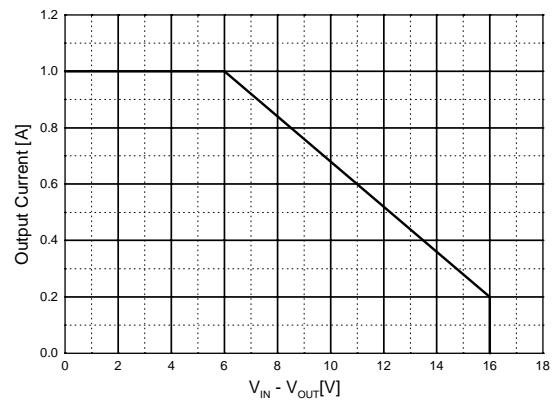

Fig 5. Quiescent current vs. Temperature.

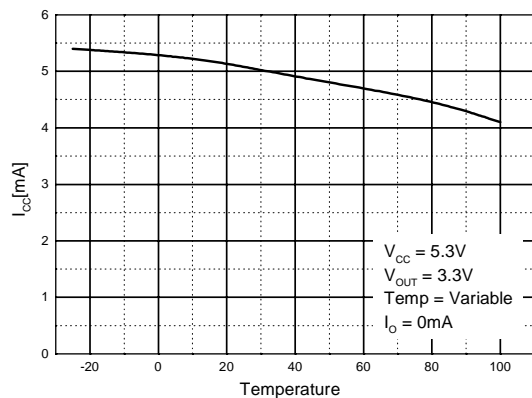
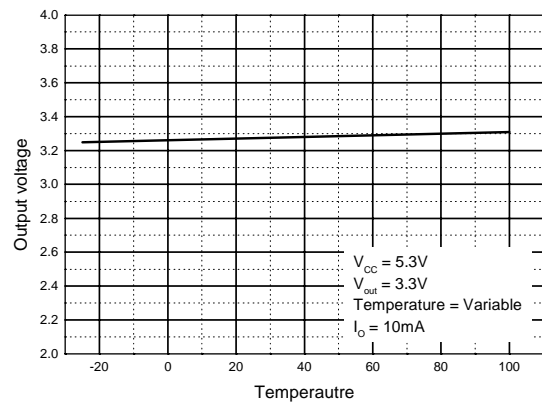
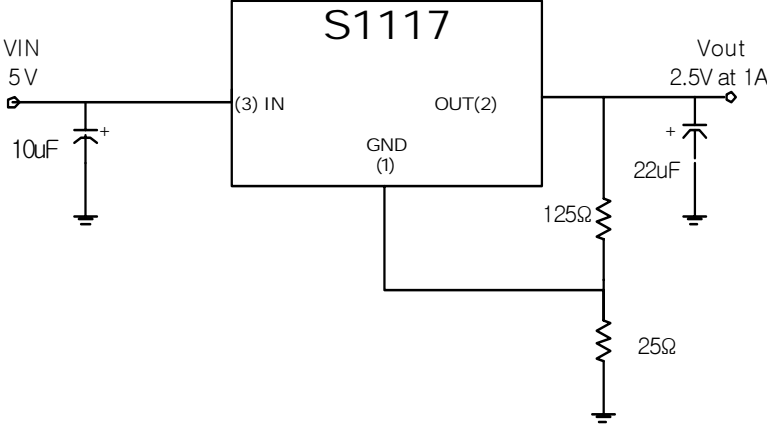

Fig 6. Output voltage vs. Temperature.



S1117

Typical Application



$$V_{out} = (1 + R_2/R_1) \times V_{ref}$$

Example) If R1 = 125ohm, Rd=25ohm,

$$V_{out} = (1 + 25/125) \times 1.25 = 1.5V$$

