

PNP Silicon Transistor

SMBTA 70

- For AF input stages and driver applications
- High current gain
- Low collector-emitter saturation voltage

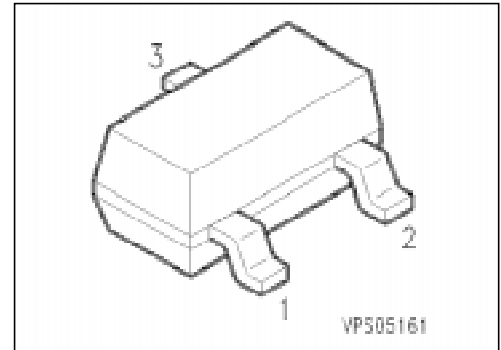

Type	Marking	Ordering Code (tape and reel)	Pin Configuration			Package ¹⁾
			1	2	3	
SMBTA 70	s2C	Q62702-M0003	B	E	C	SOT-23

Maximum Ratings

Parameter	Symbol	Values	Unit
Collector-emitter voltage	V_{CE0}	40	V
Emitter-base voltage	V_{EB0}	4	
Collector current	I_C	100	mA
Peak collector current	I_{CM}	200	
Peak base current	I_{BM}	100	
Total power dissipation, $T_s = 71\text{ °C}$	P_{tot}	330	mW
Junction temperature	T_j	150	°C
Storage temperature range	T_{stg}	- 65 ... + 150	

Thermal Resistance

Junction - ambient ²⁾	$R_{th\ JA}$	≤ 310	K/W
Junction - soldering point	$R_{th\ JS}$	≤ 240	

¹⁾ For detailed information see chapter Package Outlines.

²⁾ Package mounted on epoxy pcb 40 mm × 40 mm × 1.5 mm/6 cm² Cu.

Electrical Characteristics

at $T_A = 25\text{ °C}$, unless otherwise specified.

Parameter	Symbol	Values			Unit
		min.	typ.	max.	

DC characteristics

Collector-emitter breakdown voltage $I_C = 1\text{ mA}$	$V_{(BR)CE0}$	40	–	–	V
Emitter-base breakdown voltage $I_E = 100\text{ }\mu\text{A}$	$V_{(BR)EB0}$	4	–	–	
Collector-base cutoff current $V_{CB} = 30\text{ V}, I_E = 0$ $V_{CB} = 30\text{ V}, I_E = 0, T_A = 150\text{ °C}$	I_{CB0}	–	–	100 20	nA μA
Emitter-base cutoff current $V_{EB} = 4\text{ V}, I_C = 0$	I_{EB0}	–	–	20	nA
DC current gain $I_C = 5\text{ mA}, V_{CE} = 10\text{ V}$	h_{FE}	40	–	400	–
Collector-emitter saturation voltage ¹⁾ $I_C = 10\text{ mA}, I_B = 1\text{ mA}$	V_{CEsat}	–	–	0.25	V

AC characteristics

Transition frequency $I_C = 5\text{ mA}, V_{CE} = 10\text{ V}, f = 100\text{ MHz}$	f_t	125	–	–	MHz
Output capacitance $V_{CB} = 10\text{ V}, f = 1\text{ MHz}$	C_{obo}	–	–	4	pF

¹⁾ Pulse test conditions: $t \leq 300\text{ }\mu\text{s}$, $D \leq 2\%$.

Total power dissipation $P_{tot} = f(T_A^*; T_S)$

* Package mounted on epoxy

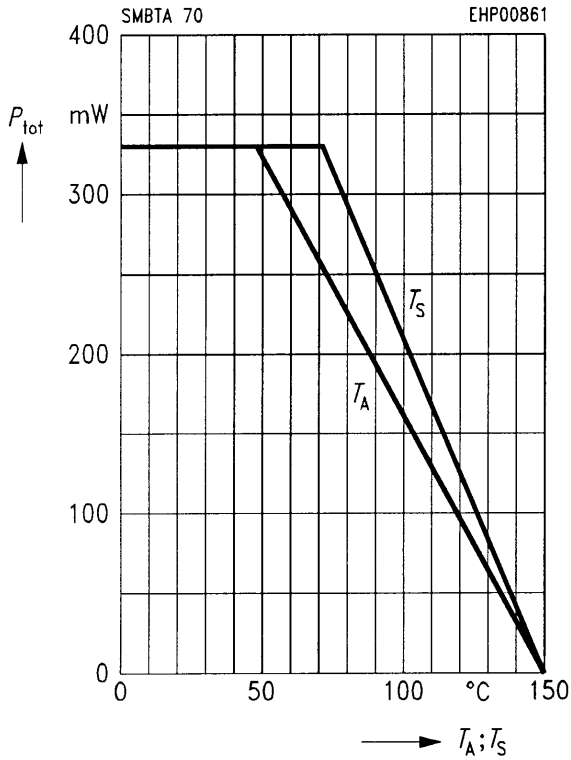

Permissible pulse load $P_{tot max}/P_{tot DC} = f(t_p)$

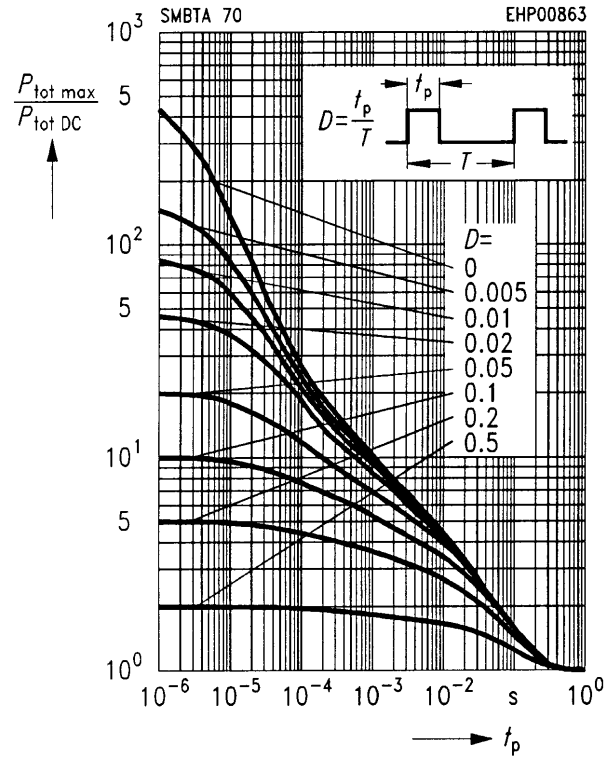

Transition frequency $f_T = f(I_C)$

$V_{CE} = 5 V$

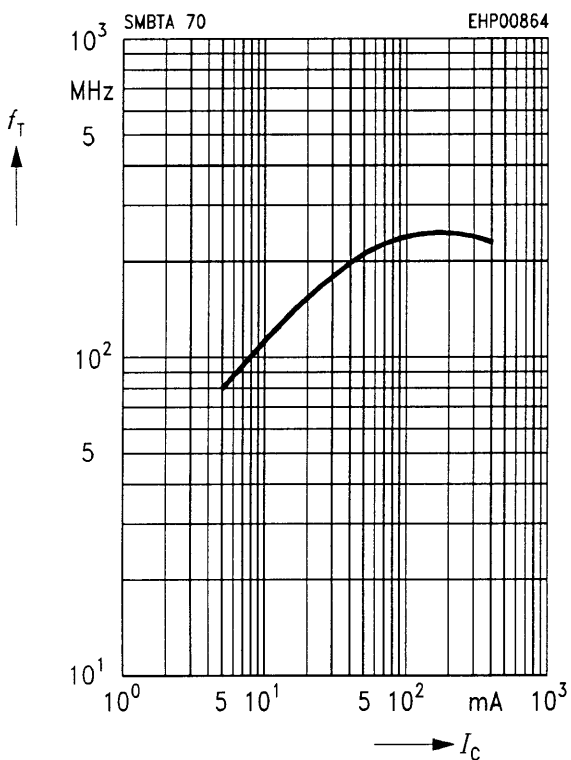

Base-emitter saturation voltage

$V_{BE sat} = f(I_C), h_{FE} = 40$

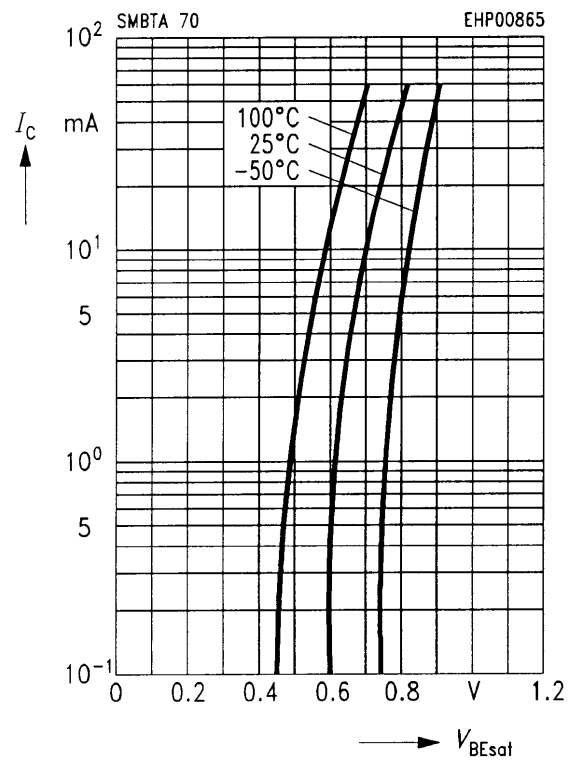

Collector-emitter saturation voltage

$I_C = f(V_{CE\ sat}), h_{FE} = 40$

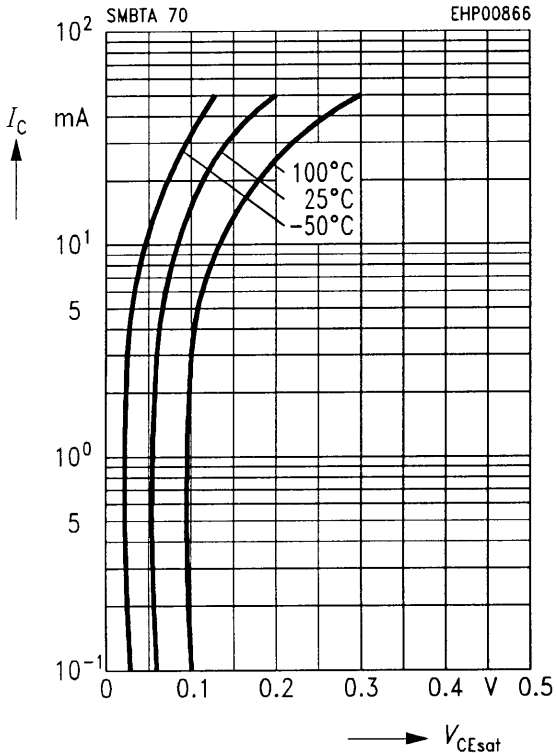

Collector current $I_C = f(V_{BE})$

$V_{CE} = 1\ V$

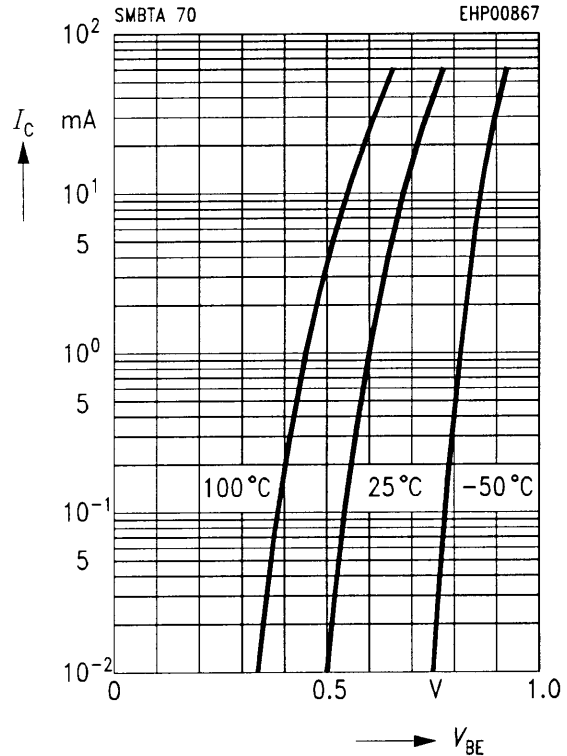

DC current gain $h_{FE} = f(I_C)$

$V_{CE} = 1\ V$

