

## MOS FET Relays

### G3VM-353H

### Analog-switching MOS FET Relay with SPST-NC (Single-pole, Single-throw, Normally Closed) Contacts

- New models in 350-V load voltage series with SPST-NC contacts and a 6-pin SOP package.
- Continuous load current of 120 mA.
- Dielectric strength of 1,500 Vrms between I/O.

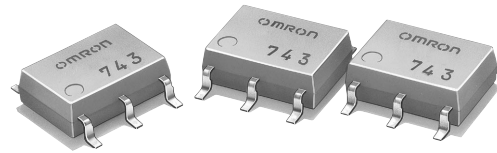

**NEW**

### Application Examples

- Broadband systems
- Measurement devices
- Data loggers
- Amusement machines

**Note:** The actual product is marked differently from the image shown here.

### List of Models

Contact form	Terminals	Load voltage (peak value)	Model	Number per stick	Number per tape
SPST-NC	Surface-mounting terminals	350 VAC	G3VM-353H	75	---
			G3VM-353H(TR)	---	2,500

### Dimensions

**Note:** All units are in millimeters unless otherwise indicated.

G3VM-353H

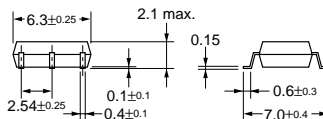
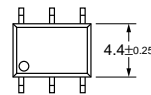
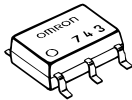

Weight: 0.13 g

**Note:** The actual product is marked differently from the image shown here.

### Terminal Arrangement/Internal Connections (Top View)

G3VM-353H

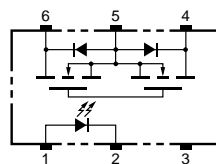

### Actual Mounting Pad Dimensions (Recommended Value, Top View)

G3VM-353H

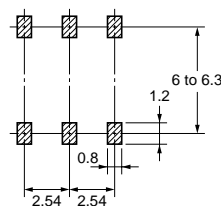

### Absolute Maximum Ratings (Ta = 25°C)

Item	Symbol	Rating	Unit	Measurement Conditions		
Input	LED forward current	$I_F$	50	mA		
	Repetitive peak LED forward current	$I_{FP}$	1	A	100 $\mu$ s pulses, 100 pps	
	LED forward current reduction rate	$\Delta I_F/^\circ\text{C}$	-0.5	mA/°C	Ta $\geq$ 25°C	
	LED reverse voltage	$V_R$	5	V		
	Connection temperature	$T_j$	125	°C		
Output	Output dielectric strength	$V_{OFF}$	350	V		
	Continuous load current	Connection A	$I_O$	120	mA	
		Connection B		120		
		Connection C		240		
	ON current reduction rate	Connection A	$\Delta I_{ON}/^\circ\text{C}$	-1.2	mA/°C	Ta $\geq$ 25°C
		Connection B		-1.2		
Connection C			-2.4			
Connection temperature	$T_j$	125	°C			
Dielectric strength between input and output (See note 1.)		$V_{I-O}$	1,500	Vrms	AC for 1 min	
Operating temperature		$T_a$	-40 to +85	°C	With no icing or condensation	
Storage temperature		$T_{stg}$	-55 to +125	°C	With no icing or condensation	
Soldering temperature (10 s)		---	260	°C	10 s	

**Note:** 1. The dielectric strength between the input and output was checked by applying voltage between all pins as a group on the LED side and all pins as a group on the light-receiving side.

Connection Diagram

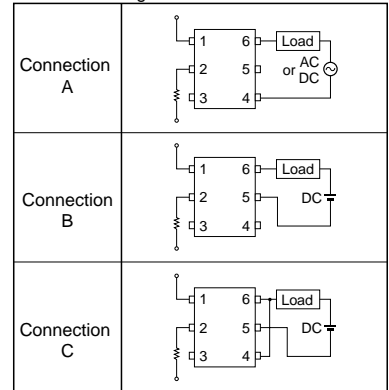

### Electrical Characteristics (Ta = 25°C)

Item	Symbol	Minimum	Typical	Maximum	Unit	Measurement conditions		
Input	LED forward voltage	$V_F$	1.0	1.15	1.3	V	$I_F = 10$ mA	
	Reverse current	$I_R$	---	---	10	$\mu$ A	$V_R = 5$ V	
	Capacity between terminals	$C_T$	---	30	---	pF	$V = 0$ , $f = 1$ MHz	
	Trigger LED forward current	$I_{FT}$	---	1.0	3.0	mA	$I_{OFF} = 10$ $\mu$ A	
Output	Maximum resistance with output ON	Connection A	$R_{ON}$	---	15	25	$\Omega$	$I_O = 120$ mA
		Connection B		---	8	14	$\Omega$	$I_O = 120$ mA
		Connection C		---	4	---	$\Omega$	$I_O = 240$ mA
	Current leakage when the relay is open	$I_{LEAK}$	---	---	1.0	$\mu$ A	$V_{OFF} = 350$ V, $I_F = 5$ mA	
Capacity between I/O terminals		$C_{I-O}$	---	0.8	---	pF	$f = 1$ MHz, $V_S = 0$ V	
Insulation resistance		$R_{I-O}$	1,000	---	---	M $\Omega$	$V_{I-O} = 500$ VDC, $RoH \leq 60\%$	
Turn-ON time		$t_{ON}$	---	---	1.0	ms	$I_F = 5$ mA, $R_L = 200$ $\Omega$ , $V_{DD} = 20$ V (See note 2.)	
Turn-OFF time		$t_{OFF}$	---	---	3.0	ms		

**Note:** 2. Turn-ON and Turn-OFF Times

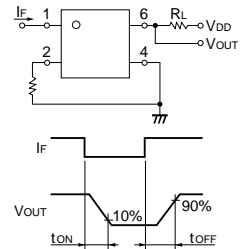

### Recommended Operating Conditions

Use the G3VM under the following conditions so that the Relay will operate properly.

Item	Symbol	Minimum	Typical	Maximum	Unit
Output dielectric strength	$V_{DD}$	---	---	280	V
Operating LED forward current	$I_F$	5	---	25	mA
Continuous load current	$I_O$	---	---	120	mA
Operating temperature	$T_a$	-20	---	65	°C

### Engineering Data

#### Load Current vs. Ambient Temperature

G3VM-353H

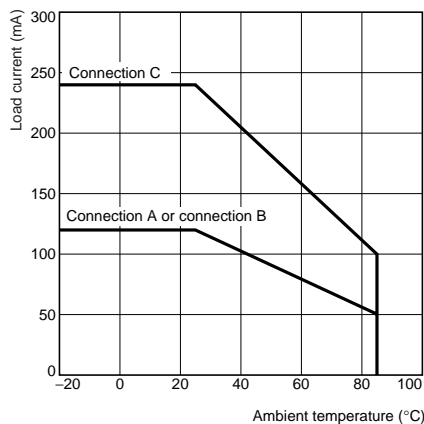

### Safety Precautions

Refer to page 6 for precautions common to all G3VM models.