

120mA LDO REGULATOR

NO.EA-074-110412

OUTLINE

The R1140Q Series are CMOS-based voltage regulator ICs with high output voltage accuracy, low supply current, low ON-resistance, and high ripple rejection. Each of these voltage regulator ICs consists of a voltage reference unit, an error amplifier, resistors for setting Output Voltage, a current limit circuit, and a chip enable circuit.

These ICs perform with low dropout voltage and a chip enable function. The line transient response and load transient response of the R1140Q Series are excellent, thus these ICs are very suitable for the power supply for hand-held communication equipment.

The output voltage of these ICs is internally fixed with high accuracy. Since the package for these ICs is SC-82AB (Super Mini-mold) package, high density mounting of the ICs on boards is possible.

FEATURES

- Ultra-Low Supply Current..... Typ. 75 μ A
- Standby Mode Typ. 0.1 μ A
- Low Dropout Voltage..... Typ. 0.15V ($I_{OUT}=100\text{mA}$, Output Voltage=3.0V Type)
- High Ripple Rejection Typ. 75dB ($f=1\text{kHz}$)
- Low Temperature-Drift Coefficient of Output Voltage... Typ. $\pm 100\text{ppm}/^\circ\text{C}$
- Excellent Line Regulation Typ. 0.05%/V
- High Output Voltage Accuracy $\pm 2.0\%$
- Output Voltage Range..... 1.5V to 4.0V
- Excellent Dynamic Response
- Small Package SC-82AB (Super Mini-mold)
- Built-in Chip Enable Circuit (B/D : active high)
- Built-in Fold-back Protection Circuit..... Typ. 40mA (Current at short mode)

APPLICATION

- Power source for cellular phones such as GSM, CDMA and various kinds of PCS.
- Power source for electrical appliances such as cameras, VCRs and camcorders.
- Power source for battery-powered equipment.

R1140Q

Discontinued

BLOCK DIAGRAMS

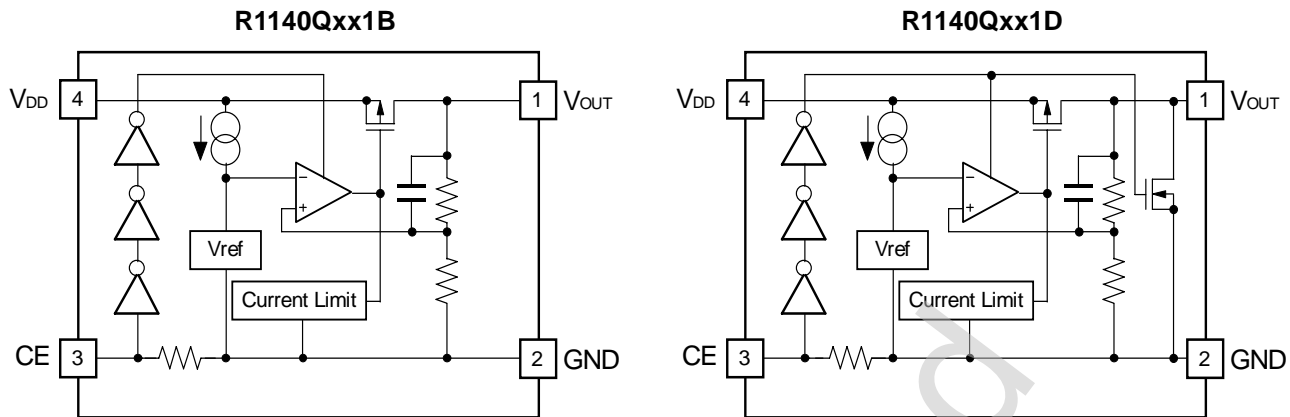

SELECTION GUIDE

The output voltage, mask option, and the taping type for the ICs can be selected at the user's request. The selection can be made by designating the part number as shown below;:

R1140Q \overline{xx} 1 \overline{x} - \overline{xx} - \overline{x} ← Part Number
 ↑ ↑ ↑ ↑ ↑
 a b c d e

Code	Contents
a	Designation of Package Type Q: SC-82AB (Super Mini-mold)
b	Setting Output Voltage (V_{OUT}): Stepwise setting with a step of 0.1V in the range of 1.5V to 4.0V is possible.
c	Designation of Mask Option : B: Without auto discharge function at OFF state. D: With auto discharge function at OFF state.
d	Designation of Taping Type : Ex. TR, TL (refer to Taping Specifications; TR type is the standard direction.)
e	Designation of composition of pin plating -F : Lead free plating

PIN CONFIGURATION

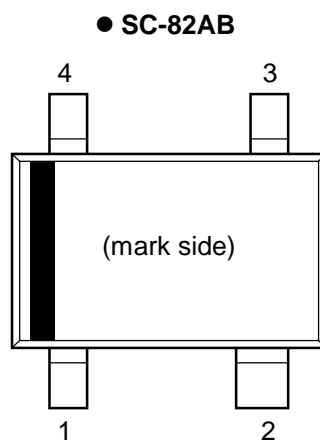

PIN DESCRIPTION

Pin No	Symbol	Pin Description
1	V_{OUT}	Output Pin
2	GND	Ground Pin
3	CE	Chip Enable Pin
4	V_{DD}	Input Pin

ABSOLUTE MAXIMUM RATINGS

Symbol	Item	Rating	Unit
V_{IN}	Input Voltage	6.5	V
V_{CE}	Input Voltage (CE Pin)	-0.3 to $V_{IN} + 0.3$	V
V_{OUT}	Output Voltage	-0.3 to $V_{IN} + 0.3$	V
I_{OUT}	Output Current	140	mA
P_D	Power Dissipation (SC-82AB)*	380	mW
T_{opt}	Operating Temperature Range	-40 to 85	°C
T_{stg}	Storage Temperature Range	-55 to 125	°C

*) For Power Dissipation, please refer to PACKAGE INFORMATION to be described.

R1140Q

Discontinued

ELECTRICAL CHARACTERISTICS

• R1140Qxx1B/D

T_{opt}=25°C

Symbol	Item	Conditions	Min.	Typ.	Max.	Unit
V _{OUT}	Output Voltage	V _{IN} =Set V _{OUT} +1.0V 1mA ≤ I _{OUT} ≤ 30mA	V _{OUT} × 0.98		V _{OUT} × 1.02	V
I _{OUT}	Output Current	V _{IN} -V _{OUT} =1.0V	120			mA
ΔV _{OUT} /ΔI _{OUT}	Load Regulation	V _{IN} =Set V _{OUT} +1.0V 1mA ≤ I _{OUT} ≤ 120mA		12	40	mV
V _{DIF}	Dropout Voltage	Refer to the ELECTRICAL CHARACTERISTICS by OUTPUT VOLTAGE				
I _{SS}	Supply Current	V _{IN} =Set V _{OUT} +1.0V		75	150	μA
I _{standby}	Supply Current (Standby)	V _{IN} =V _{CE} =Set V _{OUT} +1.0V		0.1	1.0	μA
ΔV _{OUT} /ΔV _{IN}	Line Regulation	Set V _{OUT} +0.5V ≤ V _{IN} ≤ 6.0V I _{OUT} =30mA (In case that V _{OUT} ≤ 1.6V, 2.2V ≤ V _{IN} ≤ 6.0V)		0.05	0.20	%/V
RR	Ripple Rejection	f=1kHz, Ripple 0.5Vp-p V _{IN} =Set V _{OUT} +1V, I _{OUT} =30mA (In case that V _{OUT} ≤ 1.7V, V _{IN} -V _{OUT} =1.2V)		75		dB
V _{IN}	Input Voltage		2.2		6.0	V
ΔV _{OUT} /ΔT _{opt}	Output Voltage Temperature Coefficient	I _{OUT} =30mA -40°C ≤ T _{opt} ≤ 85°C		±100		ppm/ °C
I _{LIM}	Short Current Limit	V _{OUT} =0V		40		mA
R _{PU}	\overline{CE} Pull up resistance		1.5	4.0	16.0	MΩ
V _{CEH}	\overline{CE} Input Voltage "H"		1.5		V _{IN}	V
V _{CEL}	\overline{CE} Input Voltage "L"		0.0		0.3	V
en	Output Noise	BW=10Hz to 100kHz		30		μVrms
R _{LOW}	Low Output Nch Tr. ON Resistance (of D version)	V _{CE} =0V		70		Ω

• ELECTRICAL CHARACTERISTICS by OUTPUT VOLTAGE

T_{opt} = 25°C

Output Voltage V _{OUT} (V)	Dropout Voltage V _{DIF} (V)		
	Condition	Typ.	Max.
1.5V ≤ V _{OUT} ≤ 1.6V	I _{OUT} =120mA	0.36	0.70
1.7V ≤ V _{OUT} ≤ 1.8V		0.30	0.50
1.9V ≤ V _{OUT} ≤ 2.0V		0.28	0.45
2.1V ≤ V _{OUT} ≤ 2.7V		0.24	0.40
2.8V ≤ V _{OUT} ≤ 4.0V		0.18	0.30

TECHNICAL NOTES

When using these ICs, consider the following points:

Phase Compensation

In these ICs, phase compensation is made for securing stable operation even if the load current is varied. For this purpose, be sure to use a $2.2\mu\text{F}$ or more capacitor C_{OUT} with good frequency characteristics and ESR (Equivalent Series Resistance).

(Note: When the additional ceramic capacitors are connected to the Output Pin with Output capacitor for phase compensation, the operation might be unstable. Because of this, test these ICs with as same external components as ones to be used on the PCB.)

PCB Layout

Make V_{DD} and GND line sufficient. When the impedance of these is high, it would be a cause of picking up the noise or unstable operation. Connect a capacitor with as much as $1.0\mu\text{F}$ capacitor between V_{DD} and GND pin as close as possible.

Set external components, especially output capacitor as close as possible to the ICs and make wiring shortest.

TYPICAL APPLICATION

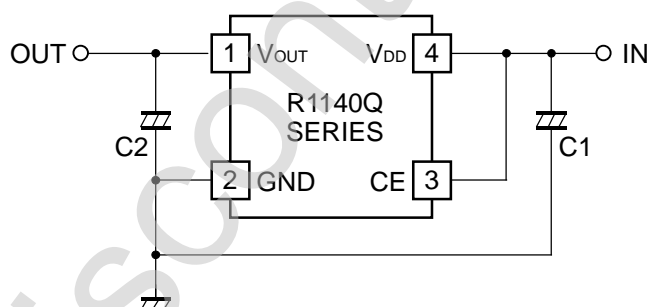

(External Components)
Output Capacitor; Tantalum Type

TEST CIRCUITS

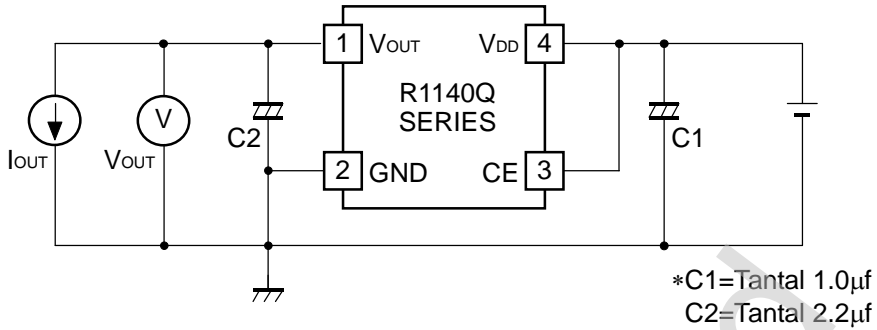

Fig.1 Standard test Circuit

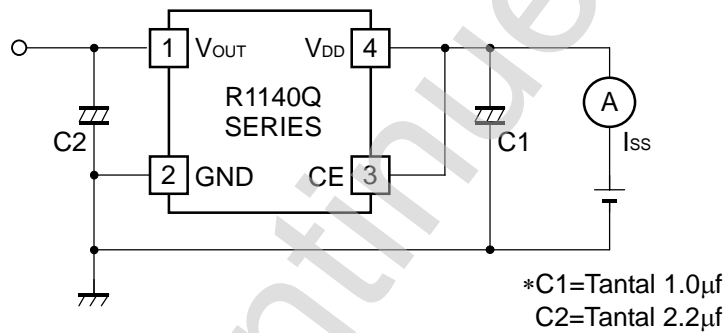

Fig.2 Supply Current Test Circuit

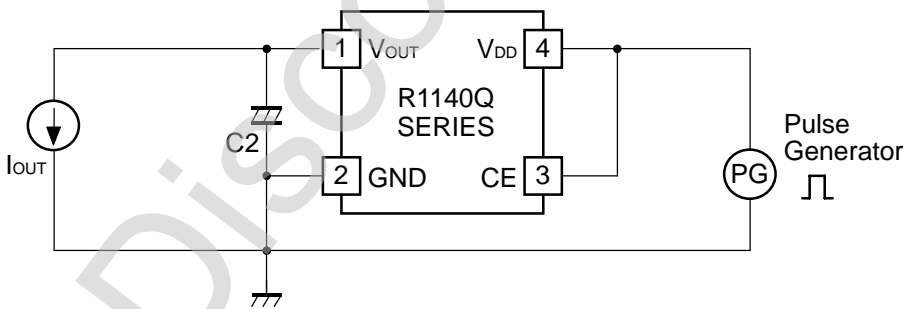

Fig.3 Ripple Rejection, Line Transient Response Test Circuit

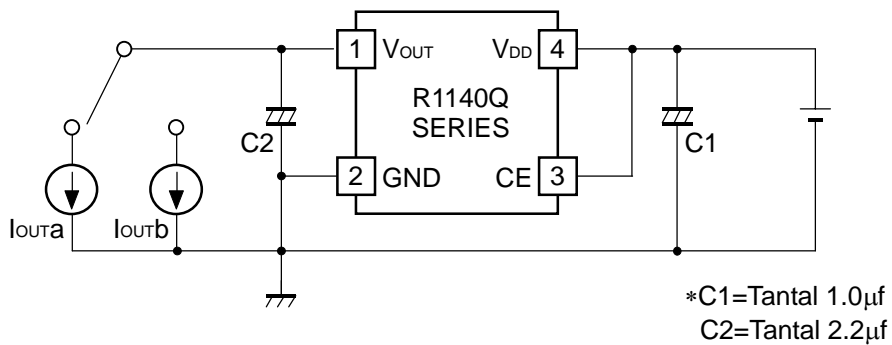
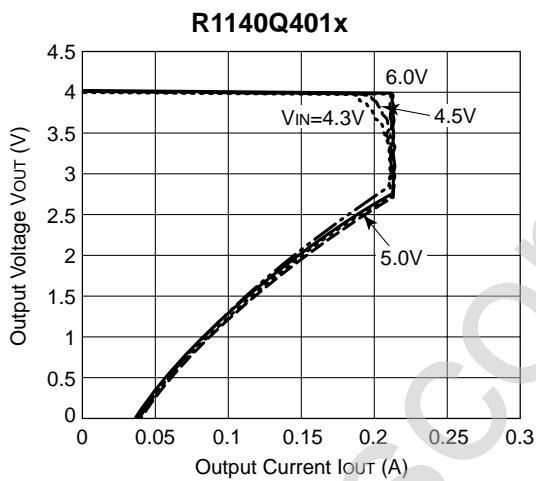
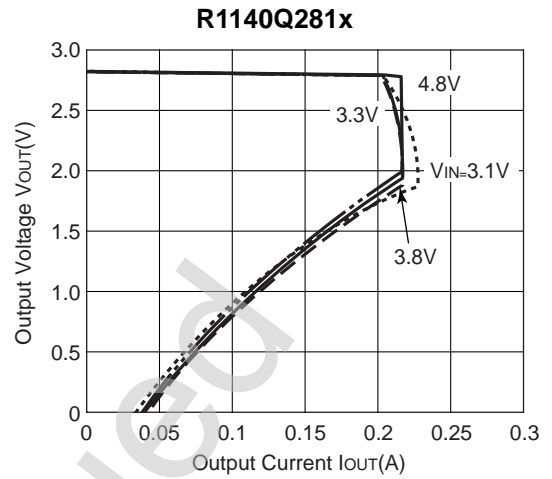
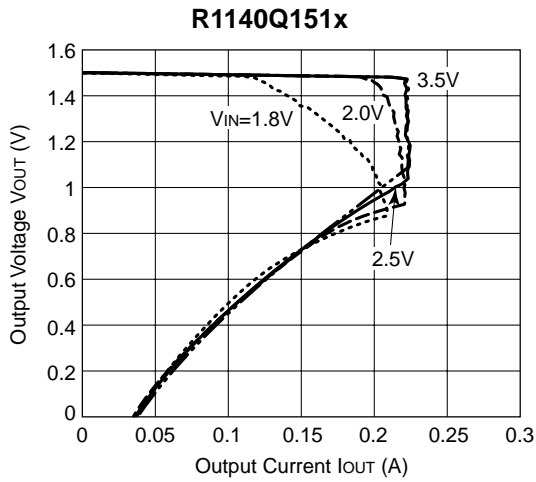

Fig.4 Load Transient Response Test Circuit

TYPICAL CHARACTERISTICS

1) Output Voltage vs. Output Current



2) Output Voltage vs. Input Voltage

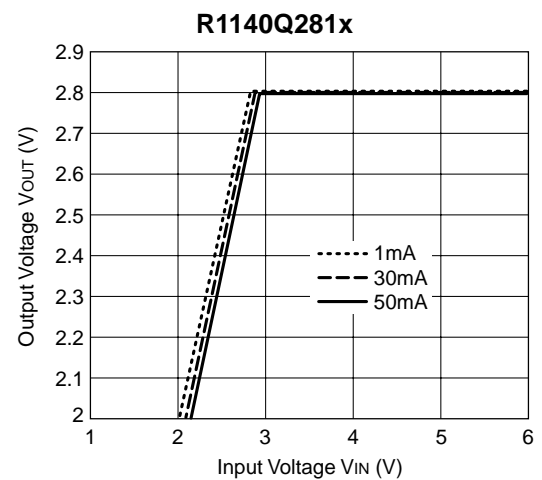
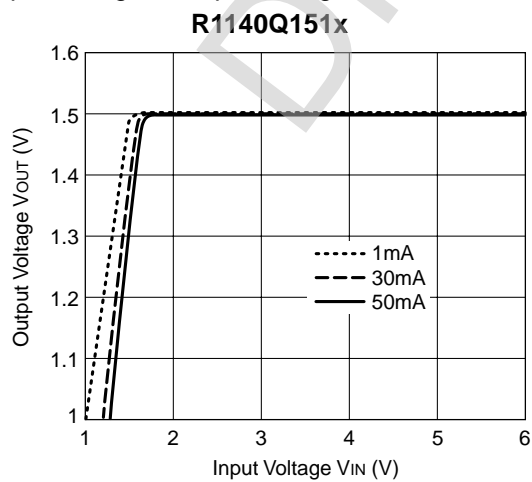

R1140Q

Discontinued

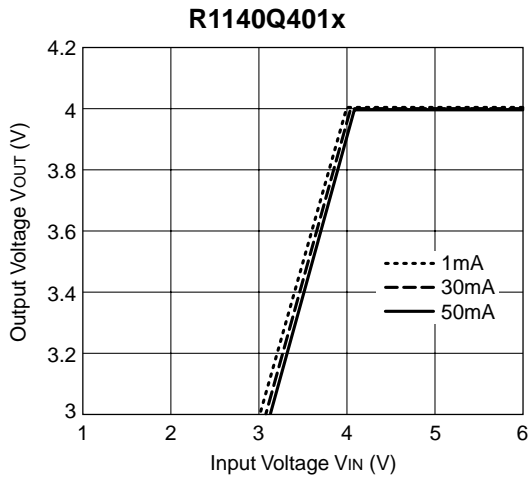

3) Dropout Voltage vs. Output Current

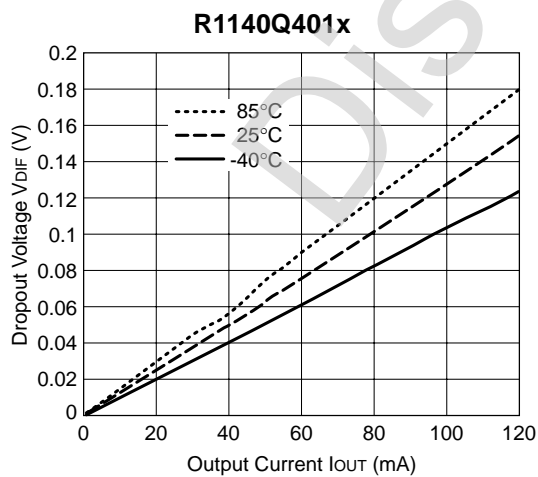
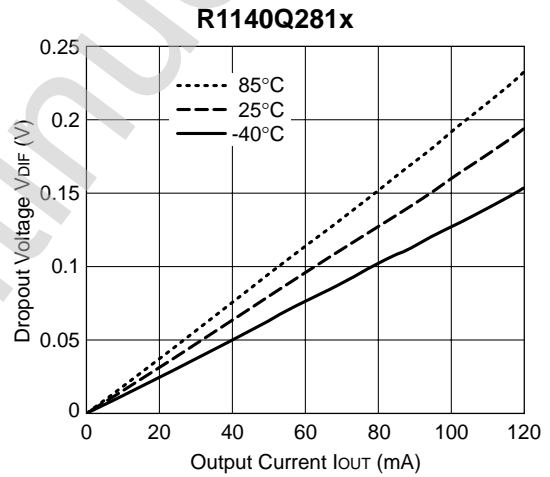
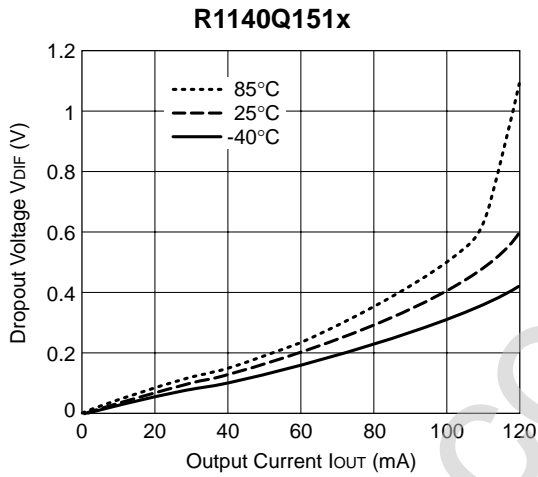

4) Output Voltage vs. Temperature

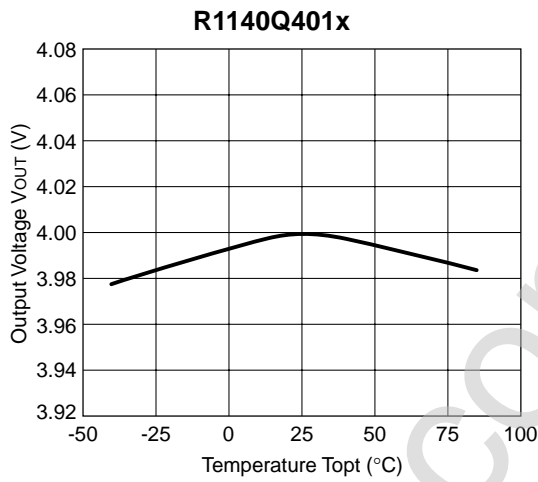
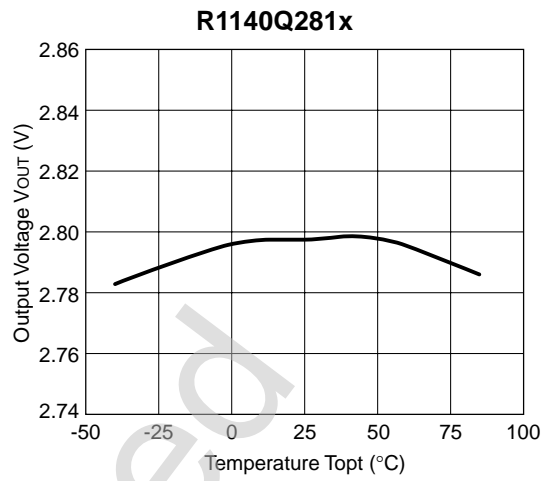
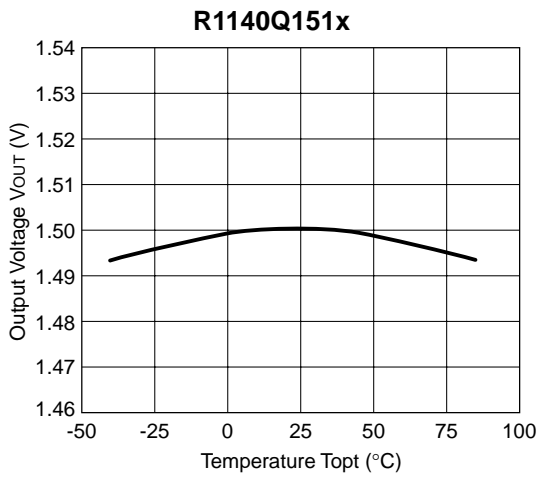

5) Supply Current vs. Input Voltage

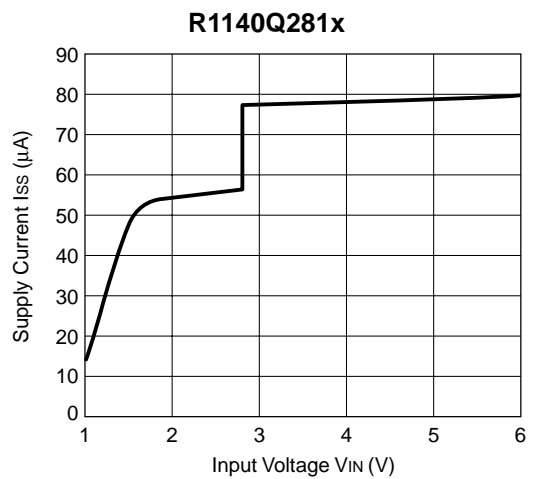
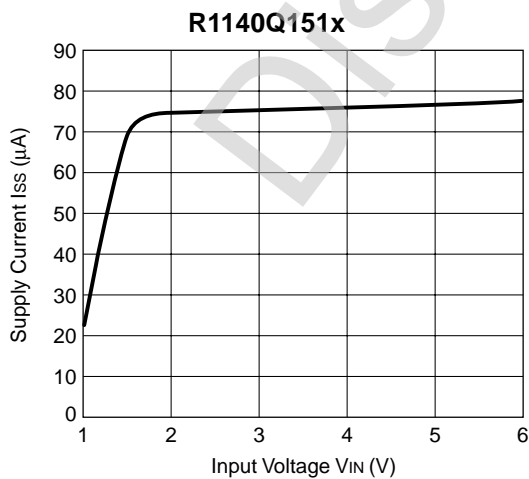

R1140Q

Discontinued

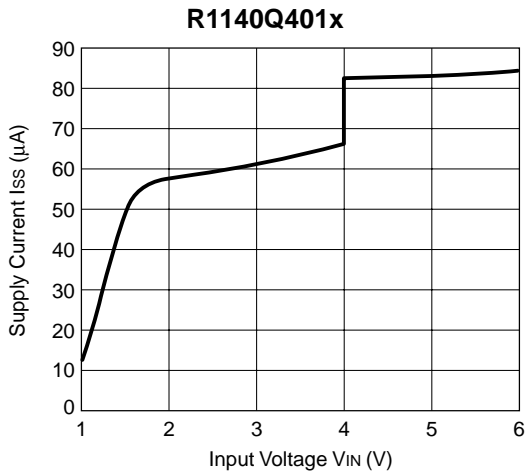

6) Supply Current vs. Temperature

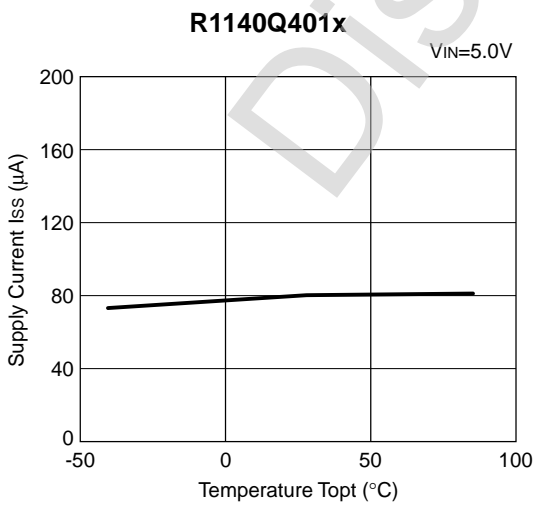
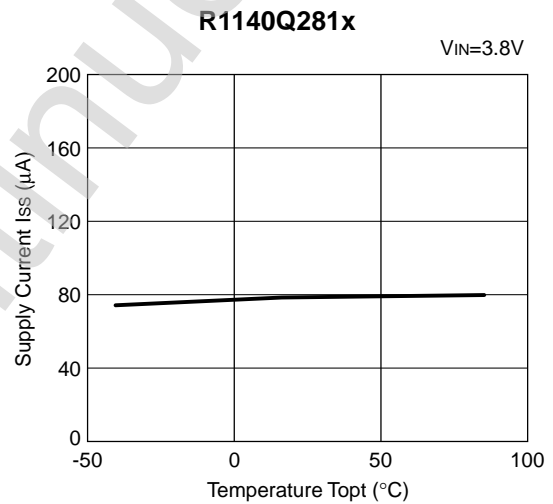
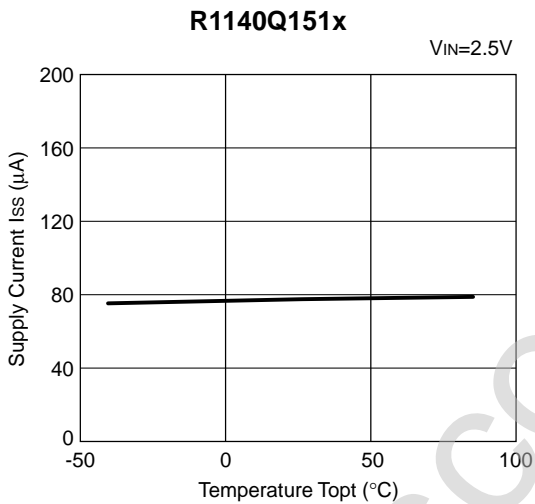

7) Dropout Voltage vs. Set Output Voltage

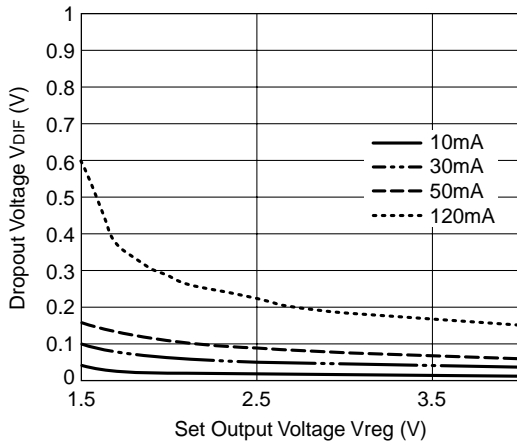

8) Ripple Rejection vs. Frequency

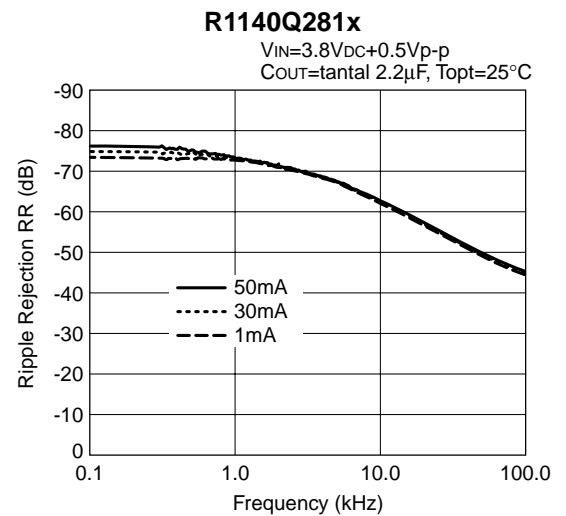
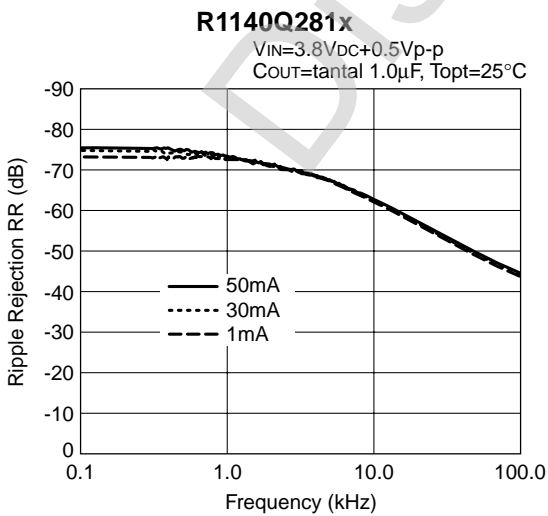
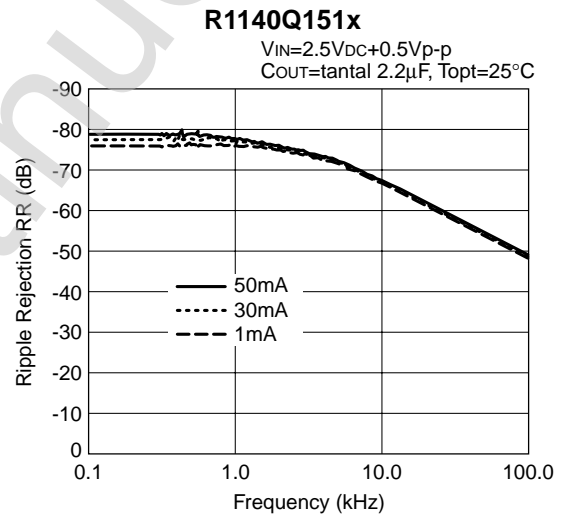
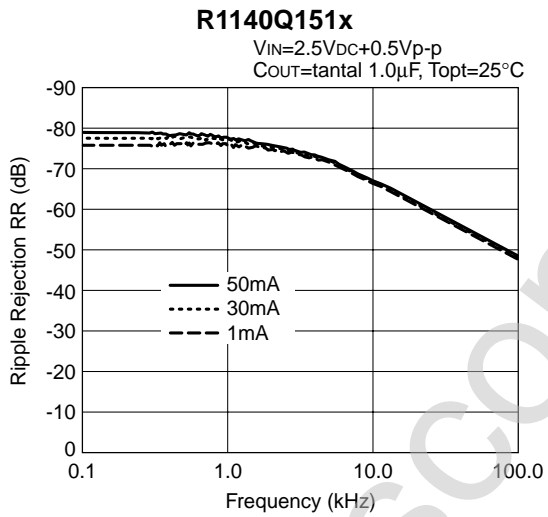

R1140Q

Discontinued

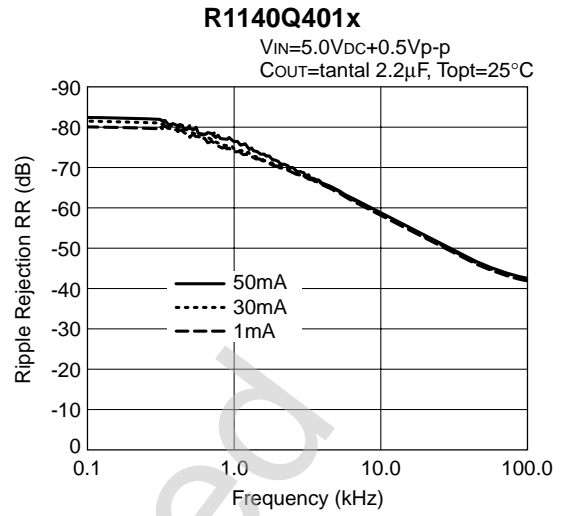
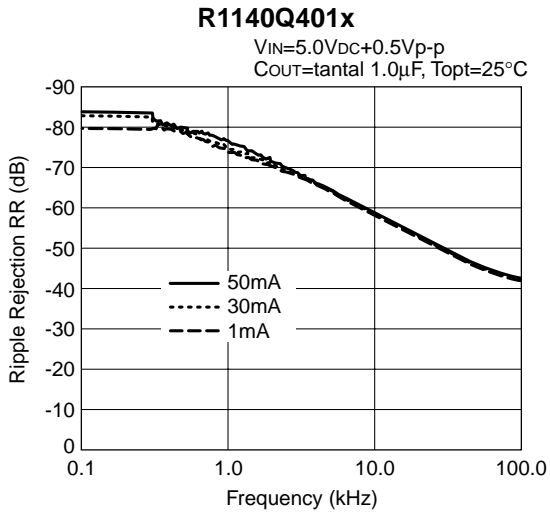

9) Ripple Rejection vs. Input Bias

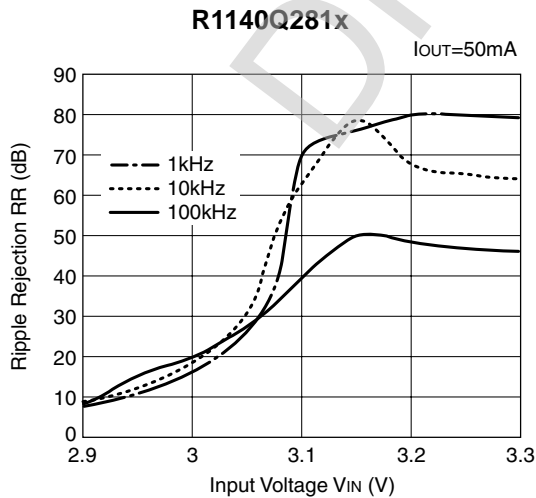
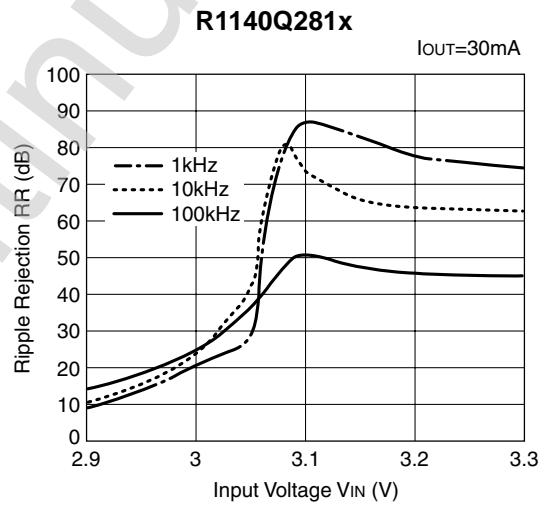
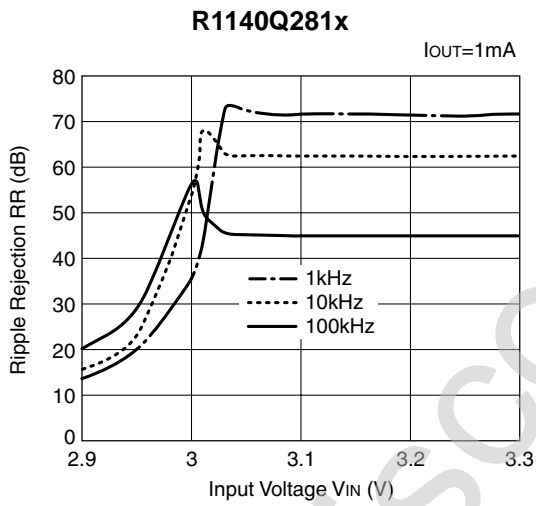

10) Input Transient Response

R1140Q281x

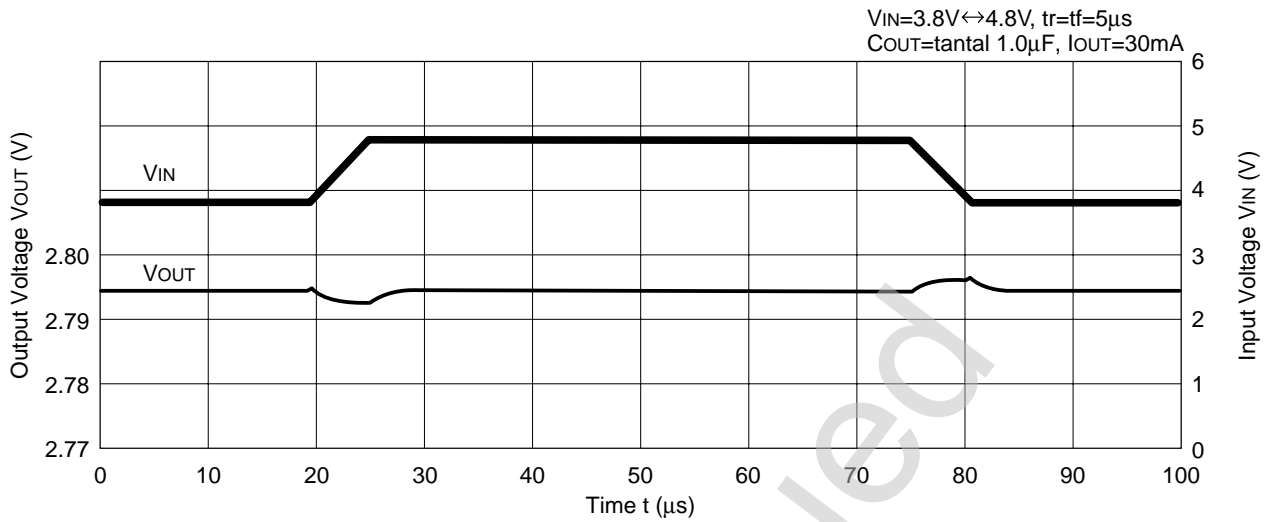

R1140Q281x

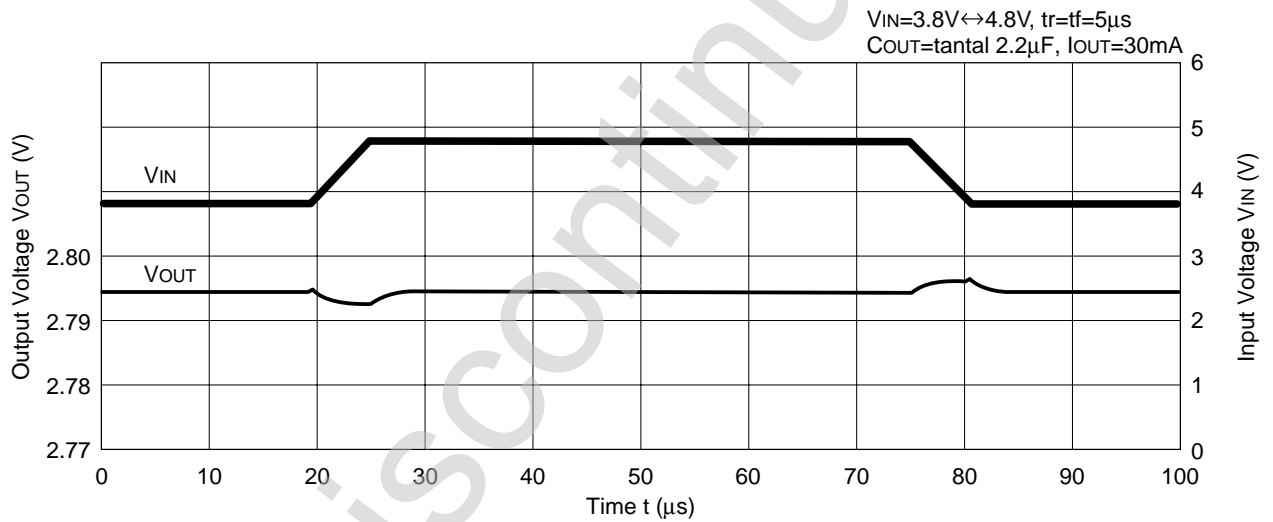

R1140Q281x

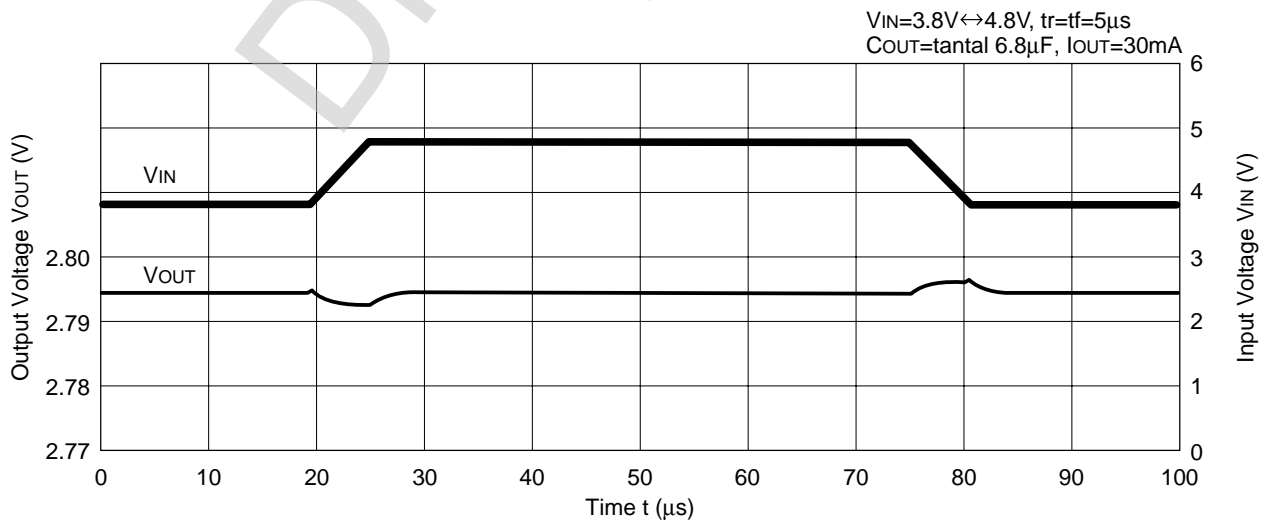

R1140Q

Discontinued

11) Input Transient Response

R1140Q281x

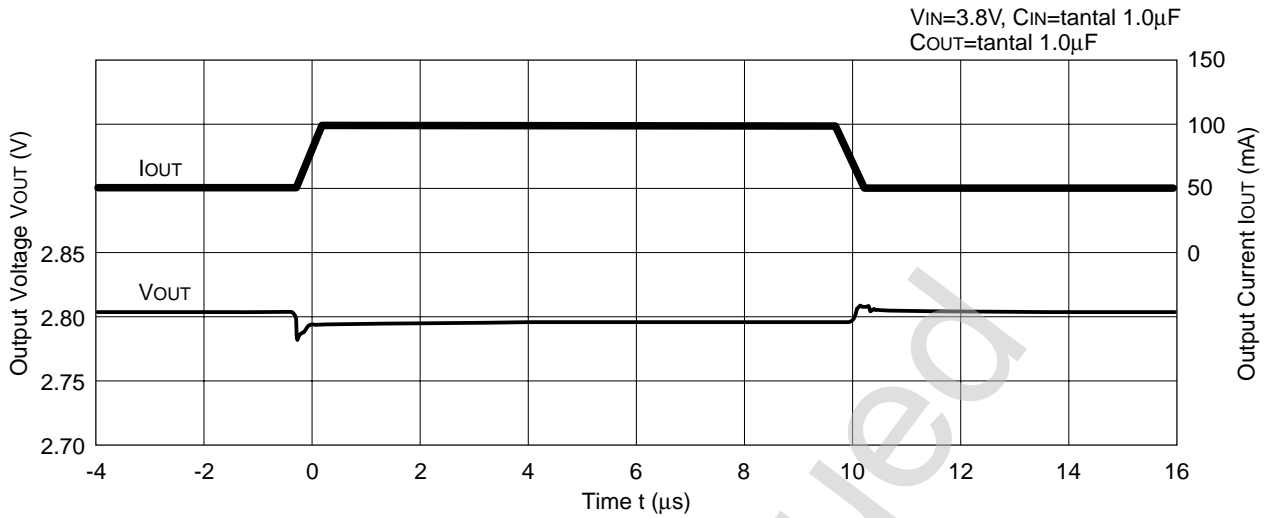

R1140Q281x

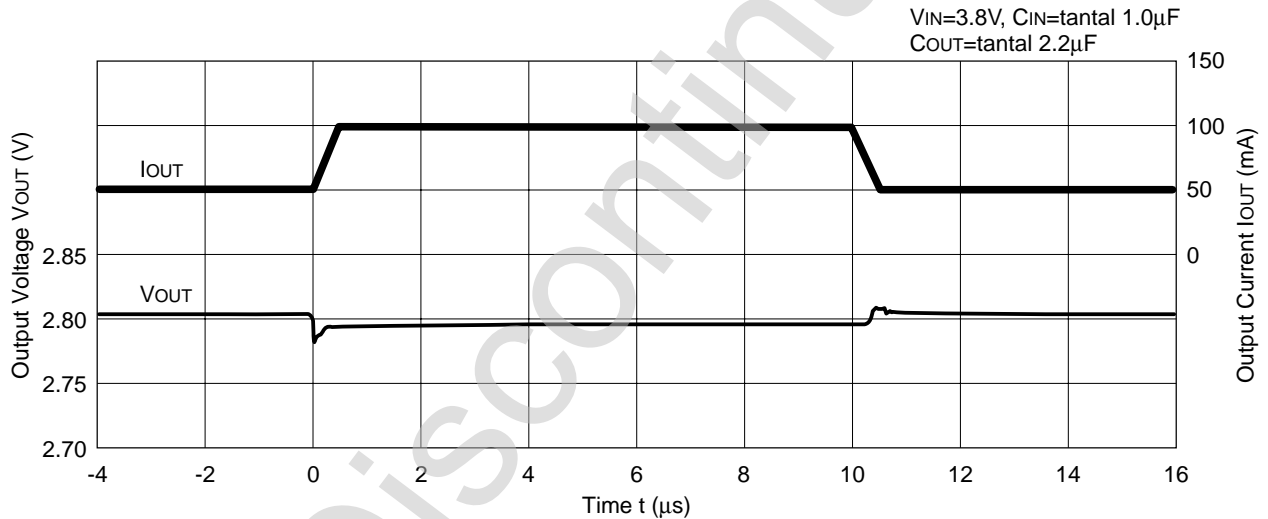

R1140Q281x

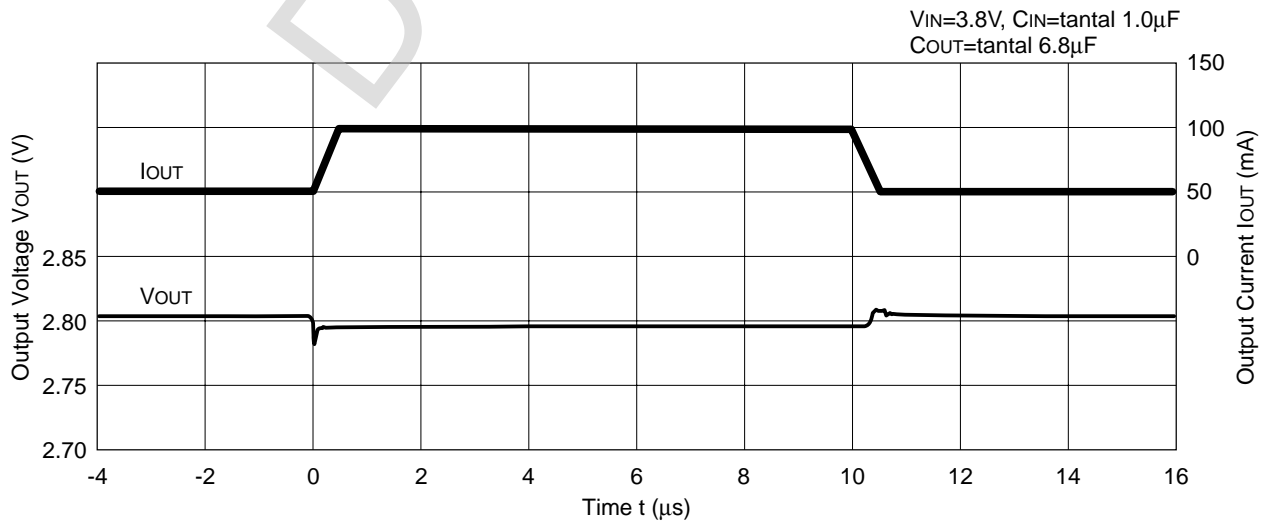

ESR vs. Output Current

When using these ICs, consider the following points:

In these ICs, phase compensation is made for securing stable operation even if the load current is varied. For this purpose, be sure to use a capacitor C_{OUT} with good frequency characteristics and ESR (Equivalent Series Resistance) of which is in the range described as follows:

The relations between I_{OUT} (Output Current) and ESR of Output Capacitor are shown below. The conditions when the white noise level is under $40\mu V$ (Avg.) are marked as the hatched area in the graph.

<Test conditions>

- (1) $V_{IN}=3.8V$
- (2) Frequency band: 10Hz to 2MHz
- (3) Temperature: $25^{\circ}C$

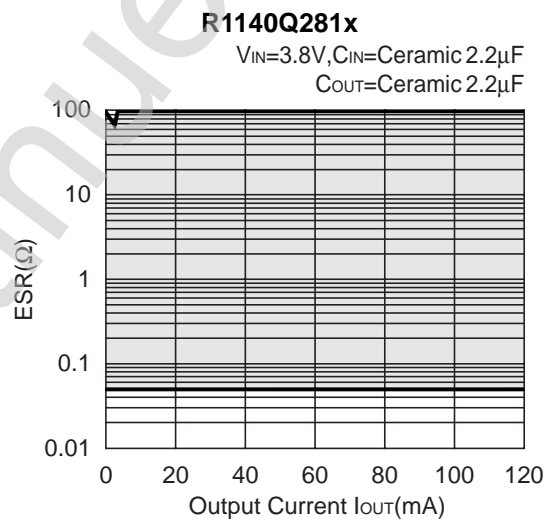
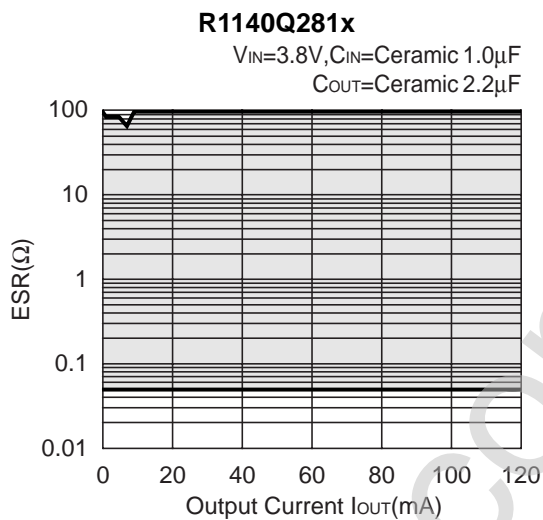



1. The products and the product specifications described in this document are subject to change or discontinuation of production without notice for reasons such as improvement. Therefore, before deciding to use the products, please refer to Ricoh sales representatives for the latest information thereon.
2. The materials in this document may not be copied or otherwise reproduced in whole or in part without prior written consent of Ricoh.
3. Please be sure to take any necessary formalities under relevant laws or regulations before exporting or otherwise taking out of your country the products or the technical information described herein.
4. The technical information described in this document shows typical characteristics of and example application circuits for the products. The release of such information is not to be construed as a warranty of or a grant of license under Ricoh's or any third party's intellectual property rights or any other rights.
5. The products listed in this document are intended and designed for use as general electronic components in standard applications (office equipment, telecommunication equipment, measuring instruments, consumer electronic products, amusement equipment etc.). Those customers intending to use a product in an application requiring extreme quality and reliability, for example, in a highly specific application where the failure or misoperation of the product could result in human injury or death (aircraft, spacevehicle, nuclear reactor control system, traffic control system, automotive and transportation equipment, combustion equipment, safety devices, life support system etc.) should first contact us.
6. We are making our continuous effort to improve the quality and reliability of our products, but semiconductor products are likely to fail with certain probability. In order to prevent any injury to persons or damages to property resulting from such failure, customers should be careful enough to incorporate safety measures in their design, such as redundancy feature, firecontainment feature and fail-safe feature. We do not assume any liability or responsibility for any loss or damage arising from misuse or inappropriate use of the products.
7. Anti-radiation design is not implemented in the products described in this document.
8. Please contact Ricoh sales representatives should you have any questions or comments concerning the products or the technical information.

RICOH COMPANY., LTD. Electronic Devices Company



■ Ricoh presented with the Japan Management Quality Award for 1999.
Ricoh continually strives to promote customer satisfaction, and shares the achievements of its management quality improvement program with people and society.



■ Ricoh awarded ISO 14001 certification.
The Ricoh Group was awarded ISO 14001 certification, which is an international standard for environmental management systems, at both its domestic and overseas production facilities. Our current aim is to obtain ISO 14001 certification for all of our business offices.

<http://www.ricoh.com/LSI/>

RICOH COMPANY, LTD. Electronic Devices Company

● **Shin-Yokohama office (International Sales)**
3-2-3, Shin-Yokohama, Kohoku-ku, Yokohama City, Kanagawa 222-8530, Japan
Phone: +81-45-477-1697 Fax: +81-45-477-1698

RICOH EUROPE (NETHERLANDS) B.V.

● **Semiconductor Support Centre**
Prof. W.H.Keesomlaan 1, 1183 DL Amstelveen, The Netherlands
P.O.Box 114, 1180 AC Amstelveen
Phone: +31-20-5474-309 Fax: +31-20-5474-791

RICOH ELECTRONIC DEVICES KOREA Co., Ltd.

11 floor, Haesung 1 building, 942, Daechidong, Gangnamgu, Seoul, Korea
Phone: +82-2-2135-5700 Fax: +82-2-2135-5705

RICOH ELECTRONIC DEVICES SHANGHAI Co., Ltd.

Room403, No.2 Building, 690#Bi Bo Road, Pu Dong New district, Shanghai 201203,
People's Republic of China
Phone: +86-21-5027-3200 Fax: +86-21-5027-3299

RICOH COMPANY, LTD. Electronic Devices Company

● **Taipei office**
Room109, 10F-1, No.51, Hengyang Rd., Taipei City, Taiwan (R.O.C.)
Phone: +886-2-2313-1621/1622 Fax: +886-2-2313-1623



Ricoh completed the organization of the Lead-free production for all of our products. After Apr. 1, 2006, we will ship out the lead free products only. Thus, all products that will be shipped from now on comply with RoHS Directive.