

LWD-SERIES

Dual output 15W ~ 50W

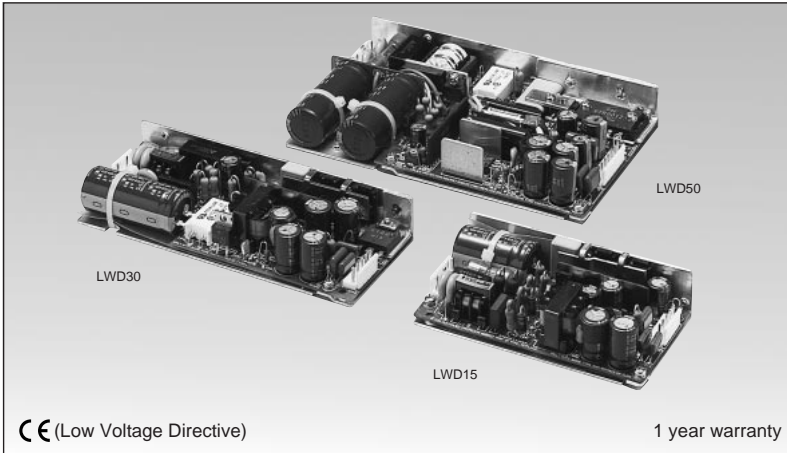

Model name **LWD 50-1212**

Name of series Output power : 15W, 30W, 50W Output voltage (Ex. of display) 1212 : 12V, 12V
0512 : 5V, 12V
0524 : 5V, 24V

Features

- CE marking (Low Voltage Directive): E. L. V output
- Wide input voltage range
85 ~ 265VAC universal input
- Low profile, 15 models, Dual output 15W ~ 50W
Thickness: Approx. 1 inch (26mm)
- Isolation between dual outputs
- 1 year warranty

Specifications

1. Input voltage range	85 ~ 265VAC (47 ~ 440 kHz), DC110 ~ 350V universal input
2. Output voltage range	CH1: +5%, CH2: Fixed
3. Cooling	Convection Cooling
4. Operating ambient temperature (Standard mounting)	0 ~ +60°C Output derating 0 ~ +40°C : 100%, +50°C : 60%, +60°C : 40%
5. Withstand voltage	Input-output: 2kVAC, input-FG: 2kVAC for 1 min.
6. Safety standard	Approved by UL1950 , CSA1402C and EN60950 (Approved as E.L.V output)
7. EMI	Conforms to FCC class A
8. Functions	Over voltage protection (CH1), Over current protection

Product lineup





Model name	CH	Nominal output voltage	Max. output current	Total max. output power	UL	CSA	EN
LWD15	LWD15-0512	CH1	5V	1.5A	14.7W	○	○
	CH2	12V	0.6A				
	LWD15-0524	CH1	5V	1.5A	14.7W	○	○
		CH2	24V	0.3A			
	LWD15-1212	CH1	12V	0.6A	14.4W	○	○
		CH2	12V	0.6A			
LWD15-1224	CH1	12V	0.6A	14.4W	○	○	
	CH2	24V	0.3A				
LWD15-1515	CH1	15V	0.5A	15.0W	○	○	
	CH2	15V	0.5A				
LWD30	LWD30-0512	CH1	5V	3.0A	29.4W	○	○
		CH2	12V	1.2A			
	LWD30-0524	CH1	5V	3.0A	29.4W	○	○
		CH2	24V	0.6A			
	LWD30-1212	CH1	12V	1.2A	28.8W	○	○
		CH2	12V	1.2A			
	LWD30-1224	CH1	12V	1.2A	28.8W	○	○
		CH2	24V	0.6A			
	LWD30-1515	CH1	15V	1.0A	30.0W	○	○
		CH2	15V	1.0A			

Model name	CH	Nominal output voltage	Max. output current	Total max. output power	UL	CSA	EN
LWD50	LWD50-0512	CH1	5V	5.0A	49.0W	○	○
		CH2	12V	2.0A			
	LWD50-0524	CH1	5V	5.0A	49.0W	○	○
		CH2	24V	1.0A			
	LWD50-1212	CH1	12V	2.0A	48.0W	○	○
		CH2	12V	2.0A			
	LWD50-1224	CH1	12V	2.0A	48.0W	○	○
		CH2	24V	1.0A			
	LWD50-1515	CH1	15V	1.6A	48.0W	○	○
		CH2	15V	1.6A			

○ : Safety standard approved

- Request customer specification for further details of specifications, outline, characteristics, etc. Read the instruction manual before usage.
- Contact us about delivery before ordering.

Recommended Noise Filter

LWD15	LWD30 / LWD50
MAW-1201-22	MAW-1202-22
	
 P134	 P134

LWD-SERIES

Unit Type Power Supply

LWD15

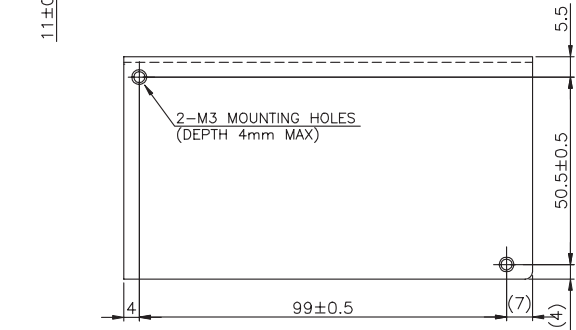
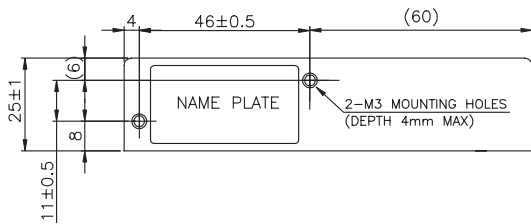
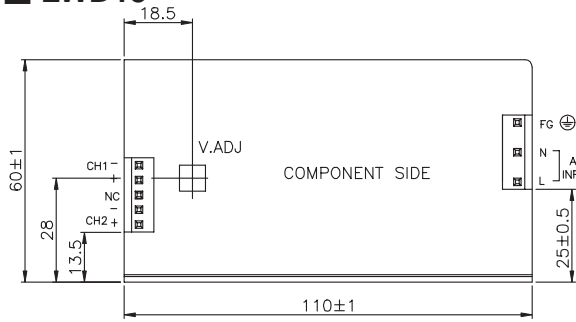

LWD50

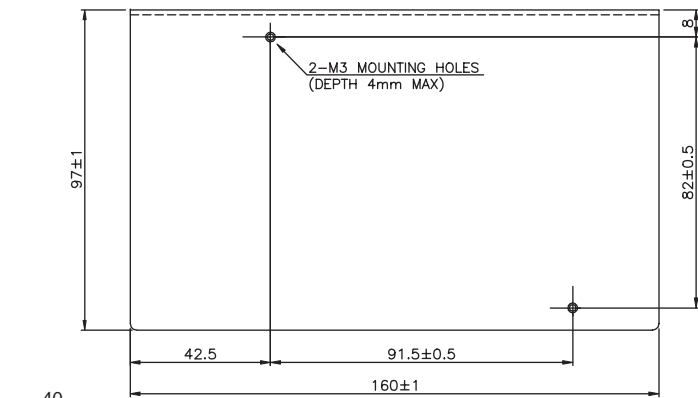
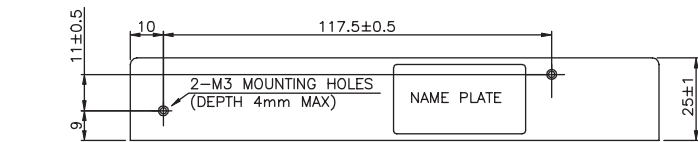
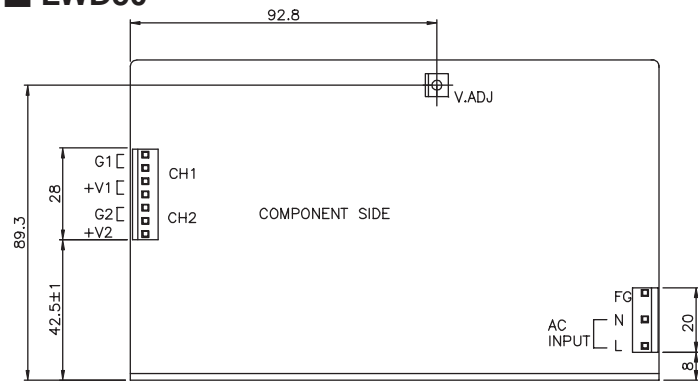

LWD30

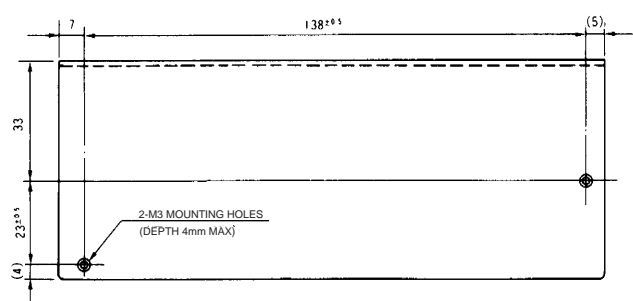
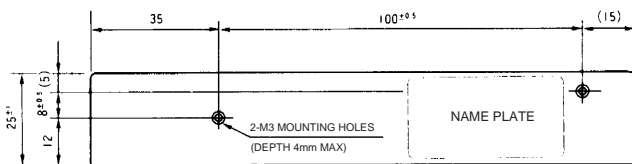
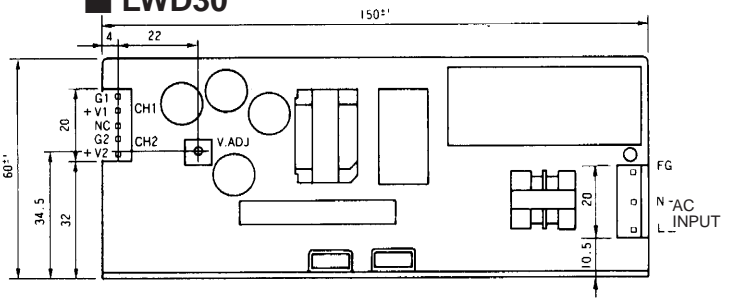

<Height of LWD-series>

● LWD15

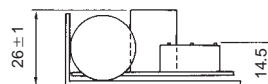

● LWD30

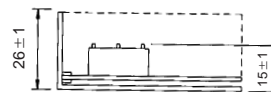

● LWD50

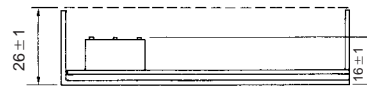

* Chassis plating dimension shall be 25mm. Dimension including mounting parts shall be 26±1mm.

(Unit: mm)