

500W Low Capacitance Surface Mount Transient Voltage Suppressor

Features

- For surface mounted applications in order to optimize board space
- Low profile package
- Built-in strain relief
- Typical maximum temperature coefficient $\Delta V_{BR}=0.1\% \times V_{BR}@25^{\circ} C \times \Delta T$
- Glass passivated chip junction
- 500W peak pulse power capability at 10x1000 μ s waveform, repetition rate (duty cycles): 0.01%
- Fast response time: typically less than 1.0ps from 0V to BVmin
- Excellent clamping capability
- Low incremental surge resistance
- High temperature to reflow soldering guaranteed: 260°C/40 seconds at terminals
- SACB series is UL recognized under component index. File number E315008
- RoHS Compliant, Halogen-Free



SMB



HALOGEN
FREE



Mechanical Data

Case:	JEDEC SMB (DO-214AA), molded plastic body over glass passivated junction
Epoxy:	Plastic package has UL flammability classification 94V-0
Terminals:	Matte Tin-plated leads. Solderable per JESD22-B102D.
Polarity:	Color band denotes the cathode end
Mounting position:	Any
Weight:	0.003 ounces, 0.093 gram

Maximum Ratings ($T_{Ambient}=25^{\circ}C$ unless noted otherwise)

Symbol	Description	Value	Unit	Conditions
PPPM	Peak Pulse Power Dissipation at $T_A=25^{\circ} C$ by 10x1000 μ s waveform	500	W	Non-repetitive current pulse, per Fig.3 and derated above $T_A=25^{\circ} C$ per Fig.2
PM(AV)	Power Dissipation on Infinite Heat Sink at $T_L=50^{\circ} C$	3	W	
IPPM	Peak Pulse Current at $T_A=25^{\circ} C$ by 10x1000 μ s waveform	See Table	A	
TJ	Operating Temperature Range	-65 to 150	$^{\circ} C$	
TSTG	Storage Temperature Range	-65 to 175	$^{\circ} C$	

500W Low Capacitance Surface Mount Transient Voltage Suppressor

SACB5.0 - SACB50

Electrical Characteristics ($T_{Ambient}=25^{\circ}C$ unless noted otherwise)

500W	Marking Code	Min. Breakdown Voltage @ Test Current		Stand-off Voltage	Max. Reverse Leakage @ V_R	Max. Clamping Voltage @ IPPM=5.0A	Max. Peak Pulse Current @ 10/1000us	Max. Junction Capacitance @ 0V	Peak Inverse Blocking Voltage	Working Inverse Blocking Voltage @ $I_{IB}=1.0mA$
		V(BR) (V)	I_T (mA)	V_R (V)	$I_R(\mu A)$	$V_C(V)$	IPPM(A)	C(pF)	V_{PIB} (V)	V_{WIB} (V)
SACB5.0	SKE	7.60	1.0	5.0	300.0	10.0	44.0	45	100	75
SACB6.0	SKG	7.90	1.0	6.0	300.0	11.2	41.0	45	100	75
SACB7.0	SKM	8.33	1.0	7.0	300.0	12.6	38.0	45	100	75
SACB8.0	SKR	8.89	1.0	8.0	100.0	13.4	36.0	45	100	75
SACB8.5	SKT	9.44	1.0	8.5	50.0	14.0	34.0	45	100	75
SACB10	SKX	11.10	1.0	10.0	5.0	16.3	29.0	45	100	75
SACB12	SLE	13.30	1.0	12.0	5.0	19.0	25.0	45	100	75
SACB15	SLM	16.70	1.0	15.0	5.0	23.6	20.0	45	100	75
SACB18	SLT	20.00	1.0	18.0	5.0	28.8	15.0	45	100	75
SACB22	SLX	24.40	1.0	22.0	5.0	35.4	14.0	45	100	75
SACB26	SME	28.90	1.0	26.0	5.0	42.3	11.1	45	100	75
SACB30	SMK	33.30	1.0	30.0	5.0	48.6	10.0	45	100	75
SACB36	SMP	40.00	1.0	36.0	5.0	60.0	8.6	45	100	75
SACB45	SMV	50.00	1.0	45.0	5.0	77.0	6.8	45	200	150
SACB50	SMZ	55.50	1.0	50.0	5.0	88.0	5.8	45	200	150

Typical Characteristics Curves

PPPM - Peak Pulse Power Dissipation (kW)

Fig.1- Peak Pulse Power Rating Curve

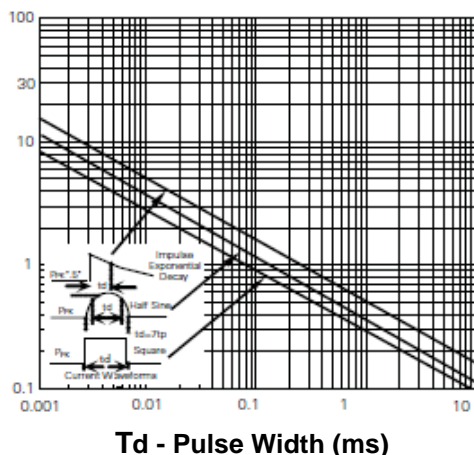

Percentage of Peak Pulse Power (%)

Fig.2- Peak Pulse Power Derating Curve

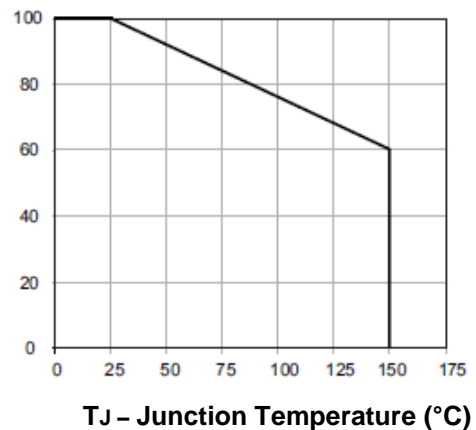

500W Low Capacitance Surface Mount Transient Voltage Suppressor

SACB5.0 - SACB50

Fig.3- Pulse Waveform

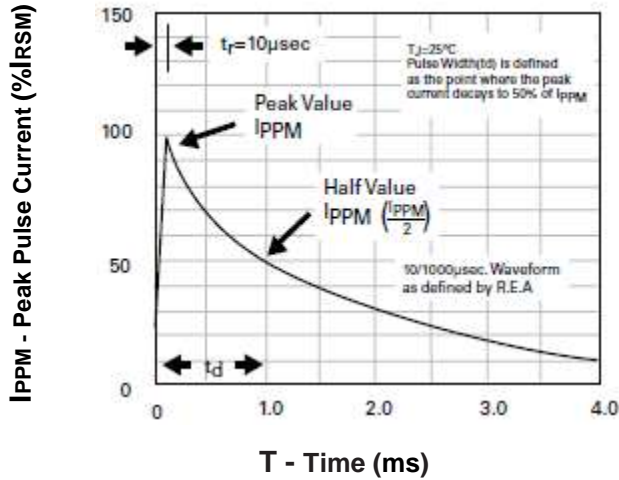
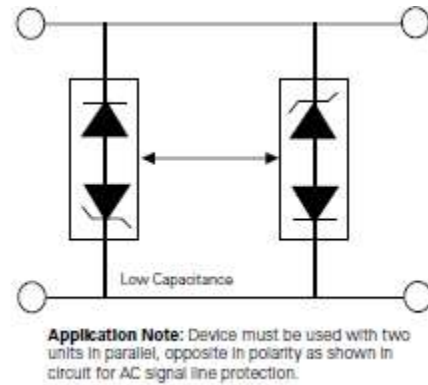
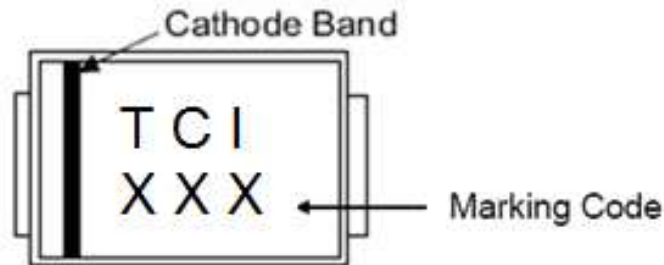

Fig.4- AC Line Protection Application



Marking Information:



500W Low Capacitance Surface Mount Transient Voltage Suppressor

SACB5.0 - SACB50

Dimensions in inch (mm)

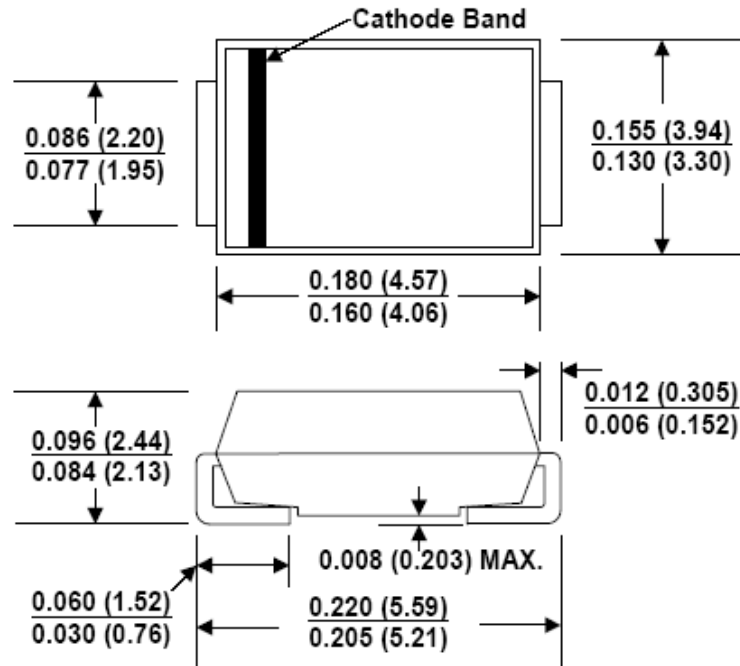

SMB

Mounting Pad Layout in inch (mm)

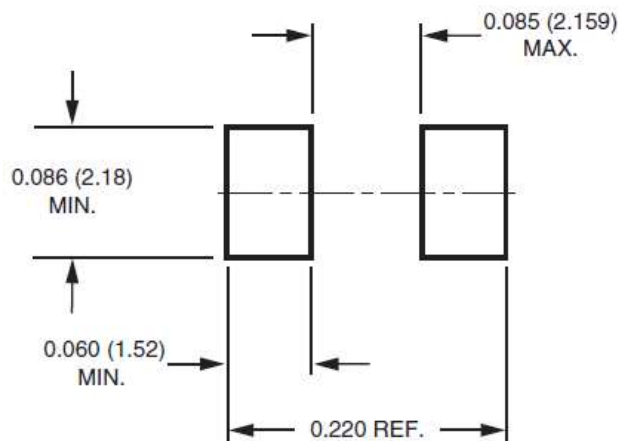

500W Low Capacitance Surface Mount Transient Voltage Suppressor

SACB5.0 - SACB50

Ordering Information

SAC B XX - XX - XX

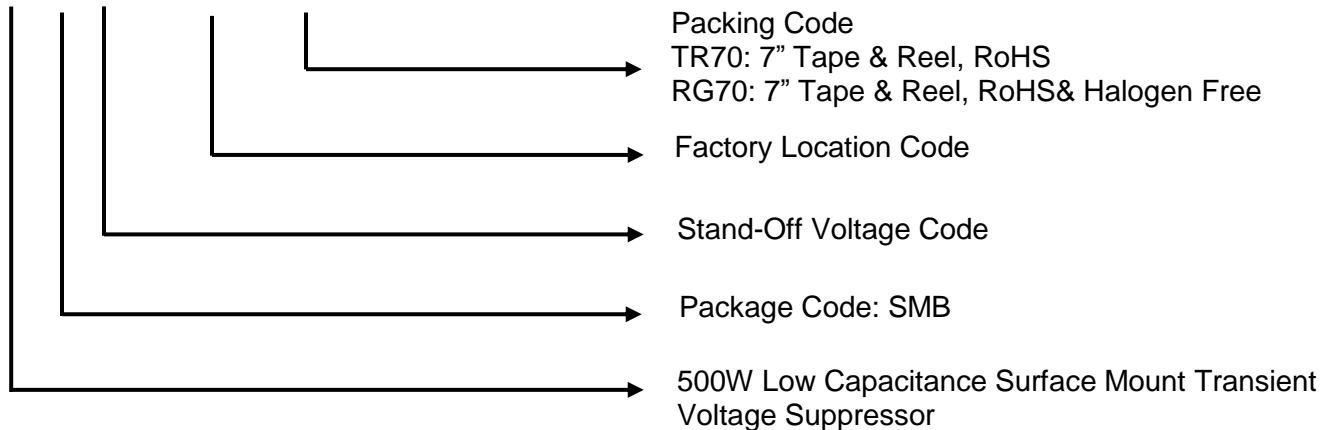

How to contact us

USA HEADQUARTERS

28040 WEST HARRISON PARKWAY, VALENCIA, CA 91355-4162

Tel: (800)-TAITRON (800)-824-8766 (661)-257-6060

Fax: (800)-TAITFAX (800)-824-8329 (661)-257-6415

Email: taitron@taitroncomponents.com

Http://www.taitroncomponents.com

TAITRON COMPONENTS INCORPORATED TAIWAN BRANCH

6F., NO.190, SEC. 2, ZHONGXING RD., XINDIAN DIST., NEW TAIPEI CITY 23146, TAIWAN R.O.C.

Tel: 886-2-2913-6238

Fax: 886-2-2913-6239

TAITRON COMPONENT TECHNOLOG SHANGHAI CORPORATION

SUITE 1503, METROBANK PLAZA, 1160 WEST YAN'AN ROAD, SHANGHAI, 200052, CHINA

Tel: +86-21-5424-9942

Fax: +86-21-2302-5027