



Höchstzulässige Werte / Maximum rated values

Elektrische Eigenschaften / Electrical properties

Kollektor-Emitter-Sperrspannung collector-emitter voltage		V_{CES}	1200	V
Kollektor-Dauergleichstrom DC-collector current	$T_C = 80\text{ °C}$	$I_{C,nom.}$	100	A
	$T_C = 25\text{ °C}$	I_C	160	A
Periodischer Kollektor Spitzenstrom repetitive peak collector current	$t_p = 1\text{ ms}, T_C = 80\text{ °C}$	I_{CRM}	200	A
Gesamt-Verlustleistung total power dissipation	$T_C=25\text{ °C}, \text{ Transistor}$	P_{tot}	650	W
Gate-Emitter-Spitzenspannung gate-emitter peak voltage		V_{GES}	+/- 20V	V
Dauergleichstrom DC forward current		I_F	100	A
Periodischer Spitzenstrom repetitive peak forw. current	$t_p = 1\text{ ms}$	I_{FRM}	200	A
Grenzlastintegral der Diode I^2t - value, Diode	$V_R = 0V, t_p = 10\text{ms}, T_{vj} = 125\text{ °C}$	I^2t	1,71	kA^2s
Isolations-Prüfspannung insulation test voltage	RMS, $f = 50\text{ Hz}, t = 1\text{ min.}$	V_{ISOL}	2,5	kV

Charakteristische Werte / Characteristic values

Transistor / Transistor

min. typ. max.

Kollektor-Emitter Sättigungsspannung collector-emitter saturation voltage	$I_C = 100A, V_{GE} = 15V, T_{vj} = 25\text{ °C}$	$V_{CE\text{ sat}}$	-	2,1	2,6	V
	$I_C = 100A, V_{GE} = 15V, T_{vj} = 125\text{ °C}$		-	2,4	2,9	V
Gate-Schwellenspannung gate threshold voltage	$I_C = 4\text{mA}, V_{CE} = V_{GE}, T_{vj} = 25\text{ °C}$	$V_{GE(th)}$	4,5	5,5	6,5	V
Gateladung gate charge	$V_{GE} = -15V...+15V$	Q_G	-	1,1	-	μC
Eingangskapazität input capacitance	$f = 1\text{MHz}, T_{vj} = 25\text{ °C}, V_{CE} = 25V, V_{GE} = 0V$	C_{ies}	-	6,5	-	nF
Rückwirkungskapazität reverse transfer capacitance	$f = 1\text{MHz}, T_{vj} = 25\text{ °C}, V_{CE} = 25V, V_{GE} = 0V$	C_{res}	-	0,42	-	nF
Kollektor-Emitter Reststrom collector-emitter cut-off current	$V_{CE} = 1200V, V_{GE} = 0V, T_{vj} = 25\text{ °C}$	I_{CES}	-	10	500	μA
	$V_{CE} = 1200V, V_{GE} = 0V, T_{vj} = 125\text{ °C}$		-	500	-	μA
Gate-Emitter Reststrom gate-emitter leakage current	$V_{CE} = 0V, V_{GE} = 20V, T_{vj} = 25\text{ °C}$	I_{GES}	-	-	400	nA

prepared by: Mark Münzer	date of publication: 09.09.1999
approved by: M. Hierholzer	revision: 2



Charakteristische Werte / Characteristic values

Transistor / Transistor		min.	typ.	max.		
Einschaltverzögerungszeit (ind. Last) turn on delay time (inductive load)	$I_C = 100A, V_{CC} = 600V$ $V_{GE} = \pm 15V, R_G = 5,6\Omega, T_{vj} = 25^\circ C$	$t_{d,on}$	-	0,06	-	μs
	$V_{GE} = \pm 15V, R_G = 5,6\Omega, T_{vj} = 125^\circ C$		-	0,06	-	μs
Anstiegszeit (induktive Last) rise time (inductive load)	$I_C = 100A, V_{CC} = 600V$ $V_{GE} = \pm 15V, R_G = 5,6\Omega, T_{vj} = 25^\circ C$	t_r	-	0,05	-	μs
	$V_{GE} = \pm 15V, R_G = 5,6\Omega, T_{vj} = 125^\circ C$		-	0,05	-	μs
Abschaltverzögerungszeit (ind. Last) turn off delay time (inductive load)	$I_C = 100A, V_{CC} = 600V$ $V_{GE} = \pm 15V, R_G = 5,6\Omega, T_{vj} = 25^\circ C$	$t_{d,off}$	-	0,35	-	μs
	$V_{GE} = \pm 15V, R_G = 5,6\Omega, T_{vj} = 125^\circ C$		-	0,40	-	μs
Fallzeit (induktive Last) fall time (inductive load)	$I_C = 100A, V_{CC} = 600V$ $V_{GE} = \pm 15V, R_G = 5,6\Omega, T_{vj} = 25^\circ C$	t_f	-	0,06	-	μs
	$V_{GE} = \pm 15V, R_G = 5,6\Omega, T_{vj} = 125^\circ C$		-	0,08	-	μs
Einschaltverlustenergie pro Puls turn-on energy loss per pulse	$I_C = 100A, V_{CC} = 600V, V_{GE} = 15V$ $R_G = 5,6\Omega, T_{vj} = 125^\circ C, L_S = 60nH$	E_{on}	-	10	-	mWs
Abschaltverlustenergie pro Puls turn-off energy loss per pulse	$I_C = 100A, V_{CC} = 600V, V_{GE} = 15V$ $R_G = 5,6\Omega, T_{vj} = 125^\circ C, L_S = 60nH$	E_{off}	-	12	-	mWs
Kurzschlußverhalten SC Data	$t_P \leq 10\mu sec, V_{GE} \leq 15V, R_G = 5,6\Omega$ $T_{vj} \leq 125^\circ C, V_{CC} = 900V, V_{CEmax} = V_{CES} - L_{sCE} \cdot di/dt$	I_{SC}	-	650	-	A
Modulinduktivität stray inductance module		L_{sCE}	-	25	-	nH
Modul Leitungswiderstand, Anschlüsse – Chip module lead resistance, terminals – chip	$T_C = 25^\circ C$	R_{CC+EE}	-	1,8	-	m Ω

Charakteristische Werte / Characteristic values

Diode / Diode		min.	typ.	max.		
Durchlaßspannung forward voltage	$I_F = 100A, V_{GE} = 0V, T_{vj} = 25^\circ C$	V_F	-	1,8	2,3	V
	$I_F = 100A, V_{GE} = 0V, T_{vj} = 125^\circ C$		-	1,7	2,2	V
Rückstromspitze peak reverse recovery current	$I_F = 100A, -di_F/dt = 2700A/\mu sec$ $V_R = 600V, V_{GE} = -15V, T_{vj} = 25^\circ C$	I_{RM}	-	125	-	A
	$V_R = 600V, V_{GE} = -15V, T_{vj} = 125^\circ C$		-	155	-	A
Sperrverzögerungsladung recovered charge	$I_F = 100A, -di_F/dt = 2700A/\mu sec$ $V_R = 600V, V_{GE} = -15V, T_{vj} = 25^\circ C$	Q_r	-	12	-	μAs
	$V_R = 600V, V_{GE} = -15V, T_{vj} = 125^\circ C$		-	22	-	μAs
Abschaltenergie pro Puls reverse recovery energy	$I_F = 100A, -di_F/dt = 2700A/\mu sec$ $V_R = 600V, V_{GE} = -15V, T_{vj} = 25^\circ C$	E_{rec}	-	4	-	mWs
	$V_R = 600V, V_{GE} = -15V, T_{vj} = 125^\circ C$		-	9	-	mWs



Thermische Eigenschaften / Thermal properties

			min.	typ.	max.	
Innerer Wärmewiderstand thermal resistance, junction to case	Transistor / transistor, DC	R_{thJC}	-	-	0,19	K/W
	Diode/Diode, DC		-	-	0,36	K/W
Übergangs-Wärmewiderstand thermal resistance, case to heatsink	pro Modul / per module $\lambda_{Paste} = 1 \text{ W/m} \cdot \text{K}$ / $\lambda_{grease} = 1 \text{ W/m} \cdot \text{K}$	R_{thCK}	-	0,009	-	K/W
Höchstzulässige Sperschichttemperatur maximum junction temperature		T_{vj}	-	-	150	°C
Betriebstemperatur operation temperature		T_{op}	-40	-	125	°C
Lagertemperatur storage temperature		T_{stg}	-40	-	150	°C

Mechanische Eigenschaften / Mechanical properties

Gehäuse, siehe Anlage case, see appendix						
Innere Isolation internal insulation				AL ₂ O ₃		
CTI comperative tracking index				225		
Anzugsdrehmoment f. mech. Befestigung mounting torque	screw M5	M1	3	6		Nm
Anzugsdrehmoment f. elektr. Anschlüsse terminal connection torque						Nm
Gewicht weight		G		300		g

Mit dieser technischen Information werden Halbleiterbauelemente spezifiziert, jedoch keine Eigenschaften zugesichert. Sie gilt in Verbindung mit den zugehörigen Technischen Erläuterungen.

This technical information specifies semiconductor devices but promises no characteristics. It is valid in combination with the belonging technical notes.



Ausgangskennlinie (typisch)
Output characteristic (typical)

$I_C = f(V_{CE})$
 $V_{GE} = 15V$

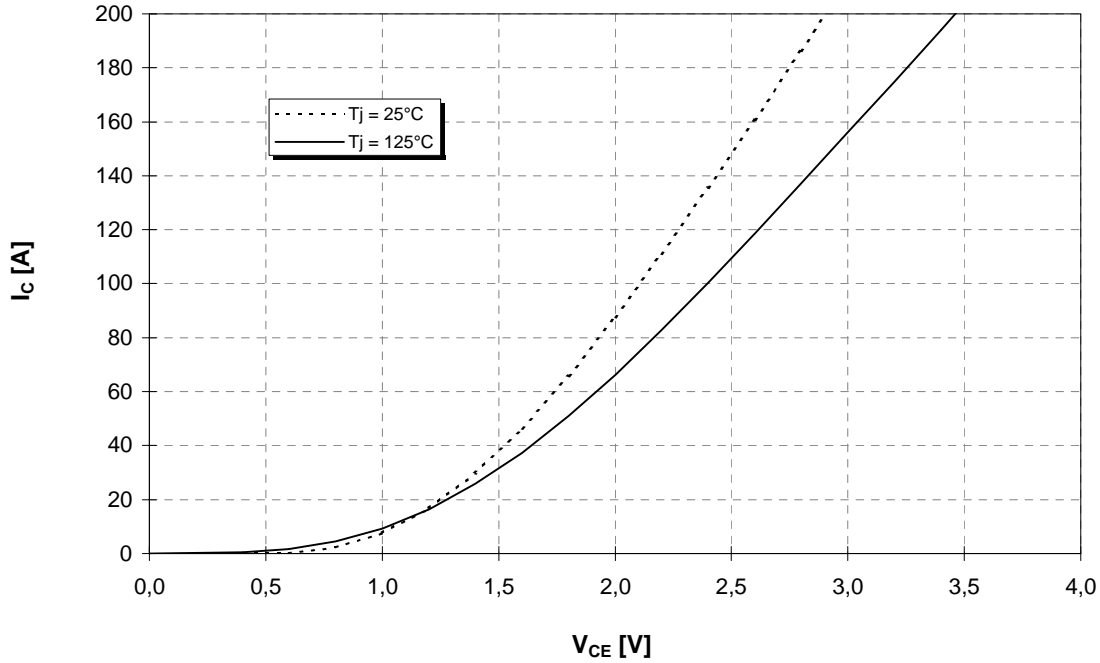

Ausgangskennlinienfeld (typisch)
Output characteristic (typical)

$I_C = f(V_{CE})$
 $T_{vj} = 125°C$

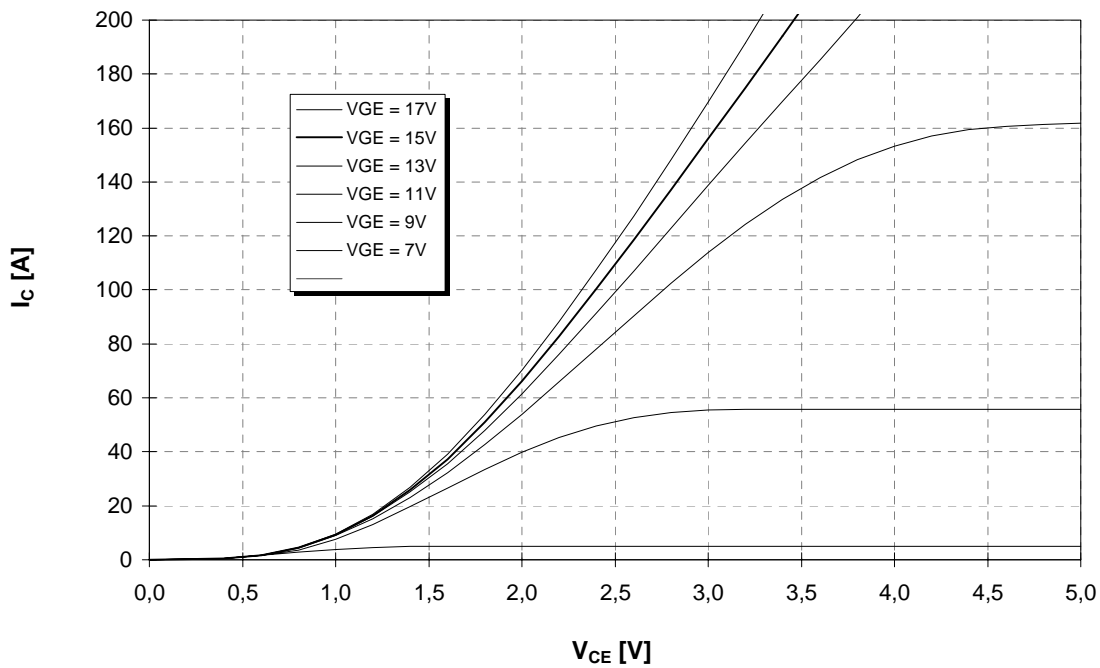



Übertragungscharakteristik (typisch)
Transfer characteristic (typical)

$I_C = f(V_{GE})$
 $V_{CE} = 20V$

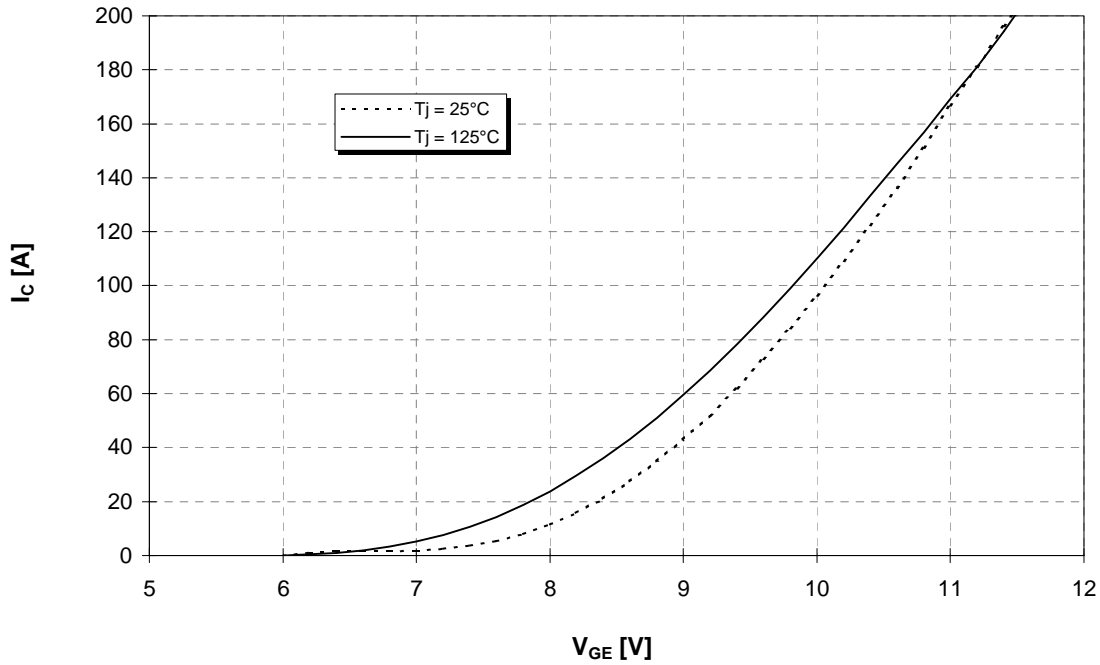

Durchlaßkennlinie der Inversdiode (typisch)
Forward characteristic of inverse diode (typical)

$I_F = f(V_F)$

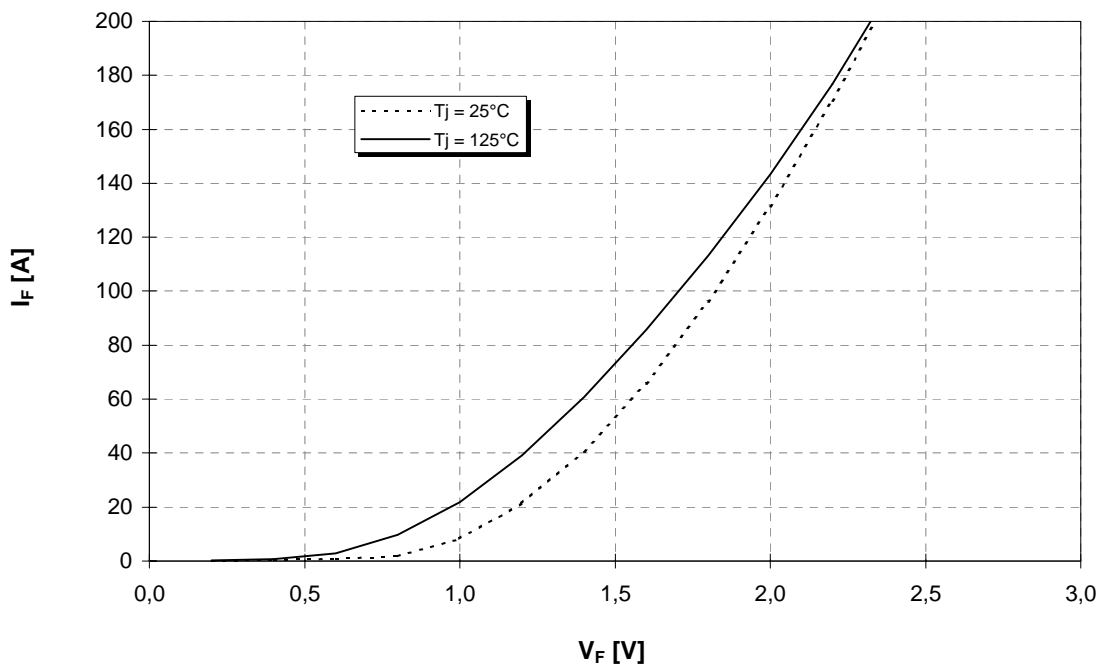



Schaltverluste (typisch) $E_{on} = f(I_C)$, $E_{off} = f(I_C)$, $E_{rec} = f(I_C)$
Switching losses (typical) $V_{GE}=15V$, $R_{gon} = R_{goff} = 5,6 \Omega$, $V_{CE} = 600V$, $T_j = 125^\circ C$

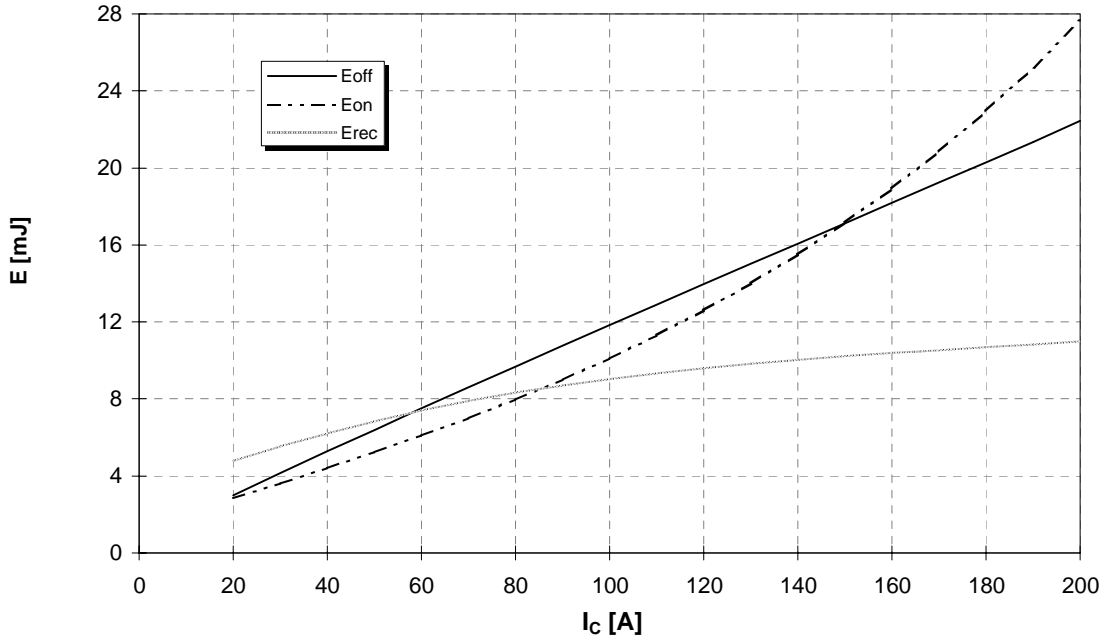

Schaltverluste (typisch) $E_{on} = f(R_G)$, $E_{off} = f(R_G)$, $E_{rec} = f(R_G)$
Switching losses (typical) $V_{GE}=15V$, $I_C = 100A$, $V_{CE} = 600V$, $T_j = 125^\circ C$

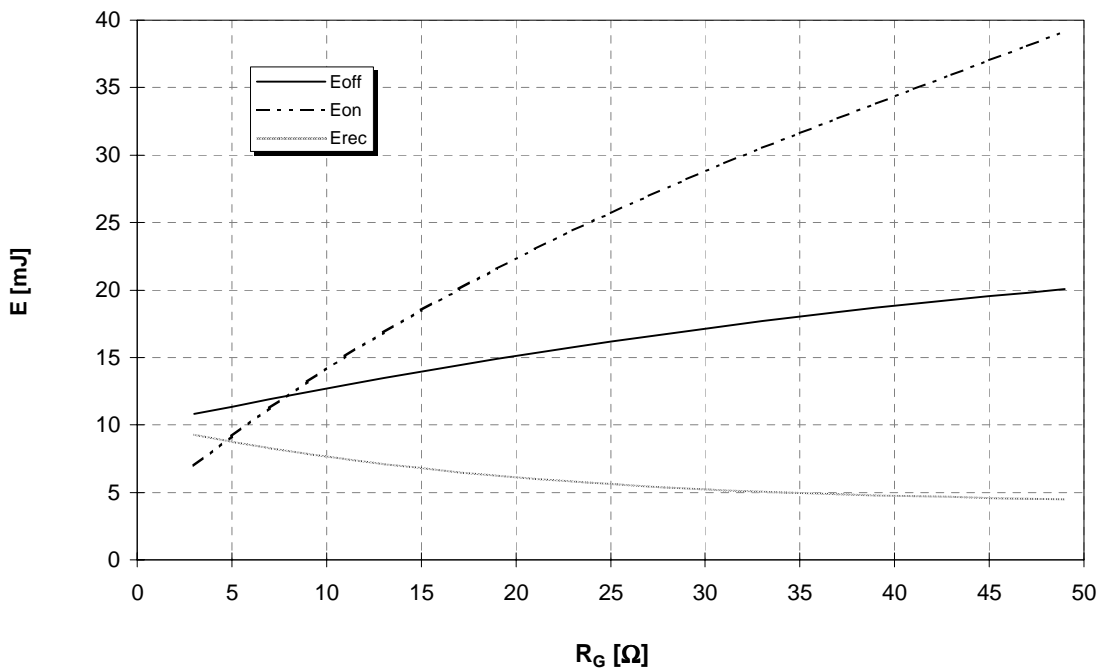



Transienter Wärmewiderstand
Transient thermal impedance

$Z_{thJC} = f(t)$

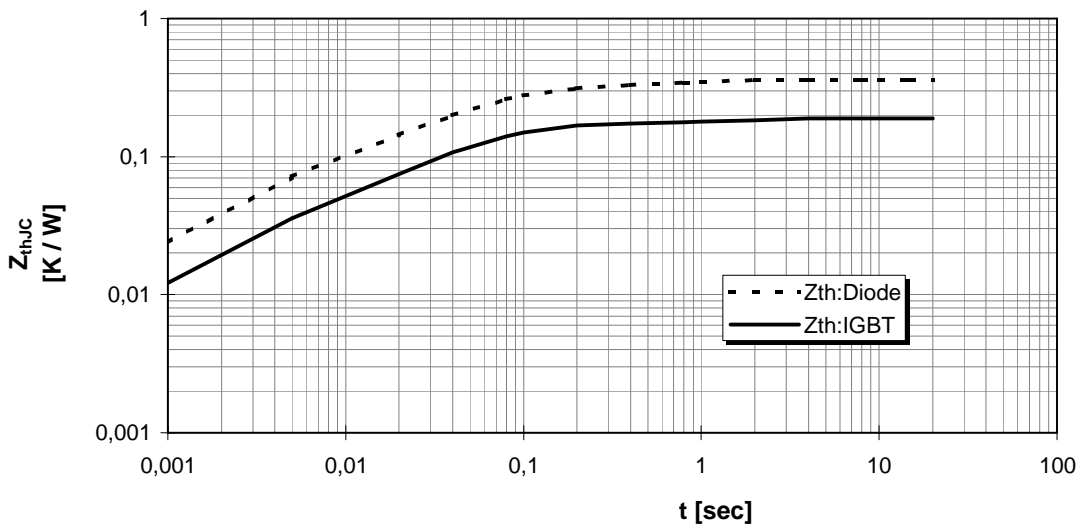

i	1	2	3	4
r_i [K/kW] : IGBT	21,25	64,32	83,81	20,62
τ_i [sec] : IGBT	0,002	0,03	0,066	1,655
r_i [K/kW] : Diode	47,11	124,78	136,14	51,97
τ_i [sec] : Diode	0,002	0,03	0,072	0,682

Sicherer Arbeitsbereich (RBSOA)

Reverse bias safe operation area (RBSOA)

$V_{GE} = 15V, R_g = 5,6 \text{ Ohm}, T_{vj} = 125^\circ C$

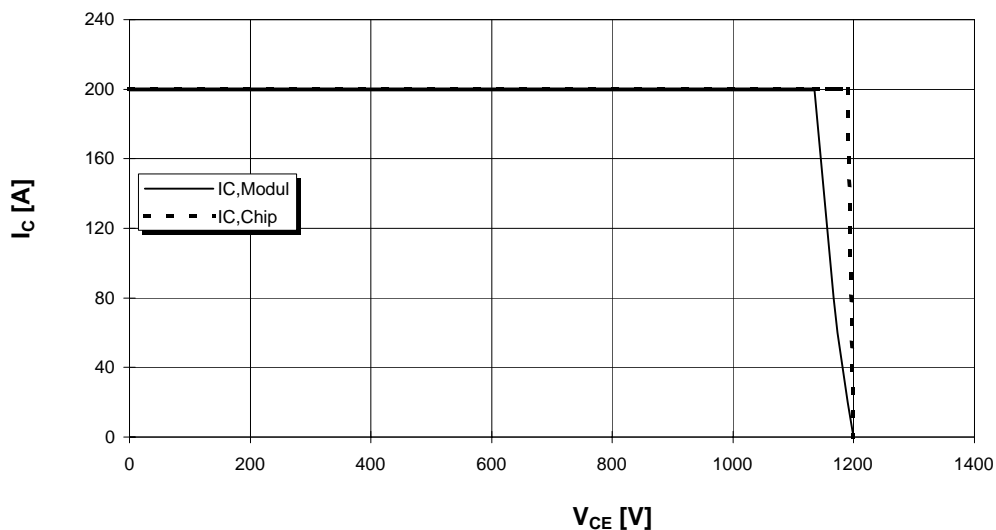



Econo 3

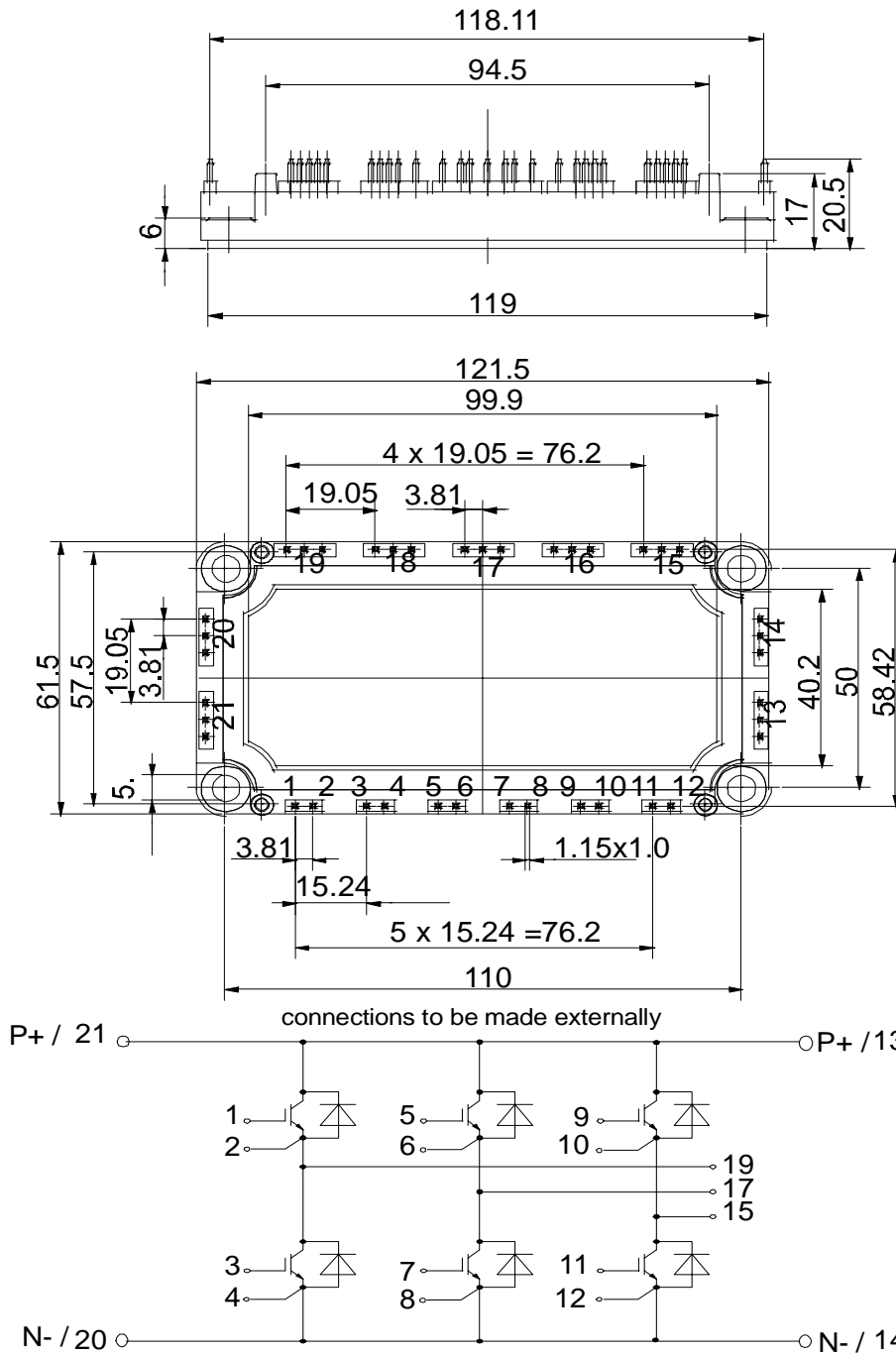

IS8