

STANDARD RECOVERY DIODES

Stud Version

Features

- High surge current capability
- Avalanche types available
- Stud cathode and stud anode version
- Wide current range
- Types up to 1200V V_{RRM}

12 A

Typical Applications

- Battery charges
- Converters
- Power supplies
- Machine tool controls

Major Ratings and Characteristics

Parameters	12F(R)	Units
$I_{F(AV)}$	12	A
@ T_C	144	°C
$I_{F(RMS)}$	19	A
I_{FSM} @ 50Hz	265	A
@ 60Hz	280	A
I^2t @ 50Hz	351	A ² s
@ 60Hz	320	A ² s
V_{RRM} range	100 to 1200	V
T_J range	- 65 to 175	°C



12F(R) Series

Bulletin I20205 rev. A 09/98

International
IR Rectifier

ELECTRICAL SPECIFICATIONS

Voltage Ratings

Type number	Voltage Code	V_{RRM} , maximum repetitive peak reverse voltage V	V_{RSM} , maximum non-repetitive peak reverse voltage V	$V_{R(BR)}$, minimum avalanche voltage V (1)	I_{RRM} max. @ $T_J = 175^\circ\text{C}$ mA
12F(R)	10	100	150	--	12
	20	200	275	--	
	40	400	500	500	
	60	600	725	750	
	80	800	950	950	
	100	1000	1200	1150	
	120	1200	1400	1350	

(1) Avalanche version only available from V_{RRM} 400V to 1200V.

Forward Conduction

Parameter	12F(R)	Units	Conditions
$I_{F(AV)}$ Max. average forward current @ Case temperature	12	A	180° conduction, half sine wave
	144	°C	
$I_{F(RMS)}$ Max. RMS forward current	19	A	
P_R Maximum non-repetitive peak reverse power	7	K/W	10µs square pulse, $T_J = T_J$ max. see note (2)
I_{FSM} Max. peak, one-cycle forward, non-repetitive surge current	265	A	t = 10ms No voltage reappplied
	280		t = 8.3ms
	225		t = 10ms 100% V_{RRM} reappplied
	235		t = 8.3ms
I^2t Maximum I^2t for fusing	351	A ² s	t = 10ms No voltage reappplied
	320		t = 8.3ms
	250		t = 10ms 100% V_{RRM} reappplied
	226		t = 8.3ms
$I^2\sqrt{t}$ Maximum $I^2\sqrt{t}$ for fusing	3510	A ² √s	t = 0.1 to 10ms, no voltage reappplied
$V_{F(TO)1}$ Low level value of threshold voltage	0.77	V	$(16.7\% \times \pi \times I_{F(AV)} < I < \pi \times I_{F(AV)})$, $T_J = T_J$ max.
$V_{F(TO)2}$ High level value of threshold voltage	0.97		$(I > \pi \times I_{F(AV)})$, $T_J = T_J$ max.
r_{f1} Low level value of forward slope resistance	10.70	mΩ	$(16.7\% \times \pi \times I_{F(AV)} < I < \pi \times I_{F(AV)})$, $T_J = T_J$ max.
r_{f2} High level value of forward slope resistance	6.20		$(I > \pi \times I_{F(AV)})$, $T_J = T_J$ max.
V_{FM} Max. forward voltage drop	1.26	V	$I_{pk} = 38\text{A}$, $T_J = 25^\circ\text{C}$, $t_p = 400\mu\text{s}$ rectangular wave

(2) Available only for Avalanche version, all other parameters the same as 12F.

Thermal and Mechanical Specifications

Parameter	12F(R)	Units	Conditions
T _J Max. junction operating temperature range	-65 to 175	°C	
T _{stg} Max. storage temperature range	-65 to 200		
R _{thJC} Max. thermal resistance, junction to case	2	K/W	DC operation
R _{thCS} Max. thermal resistance, case to heatsink	0.5		Mounting surface, smooth, flat and greased
T Mounting torque, ± 10%	1.2 (1.5)	Nm	Lubricated threads (Not lubricated threads)
wt Approximate weight	7 (0.25)	g (oz)	
Case style	DO-203AA (DO-4)		See Outline Table

ΔR_{thJC} Conduction

(The following table shows the increment of thermal resistance R_{thJC} when devices operate at different conduction angles than DC)

Conduction angle	Sinusoidal conduction	Rectangular conduction	Units	Conditions
180°	0.33	0.26	K/W	T _J = T _J max.
120°	0.41	0.44		
90°	0.53	0.58		
60°	0.78	0.81		
30°	1.28	1.29		

Ordering Information Table

Device Code

A	12	F	R	120	M
①	②	③	④	⑤	⑥

- 1** - A = Avalanche diode
None = Standard diode
- 2** - Current rating: Code = I_{F(AV)}
- 3** - F = Standard device
- 4** - None = Stud Normal Polarity (Cathode to Stud)
R = Stud Reverse Polarity (Anode to Stud)
- 5** - Voltage code: Code x 10 = V_{RRM} (See Voltage Ratings table)
- 6** - None = Stud base DO-203AA (DO-4) 10-32UNF-2A
M = Stud base DO-203AA (DO-4) M5 X 0.8 - (Not available for Avalanche diodes)

12F(R) Series

Bulletin I20205 rev. A 09/98

Outlines Table

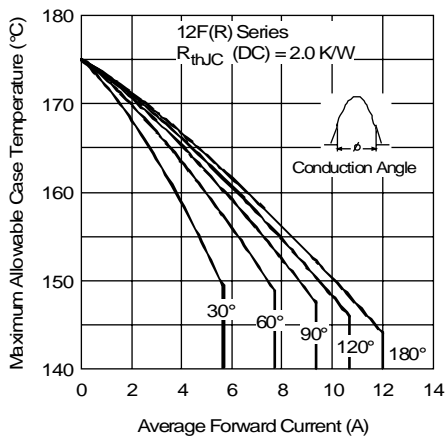
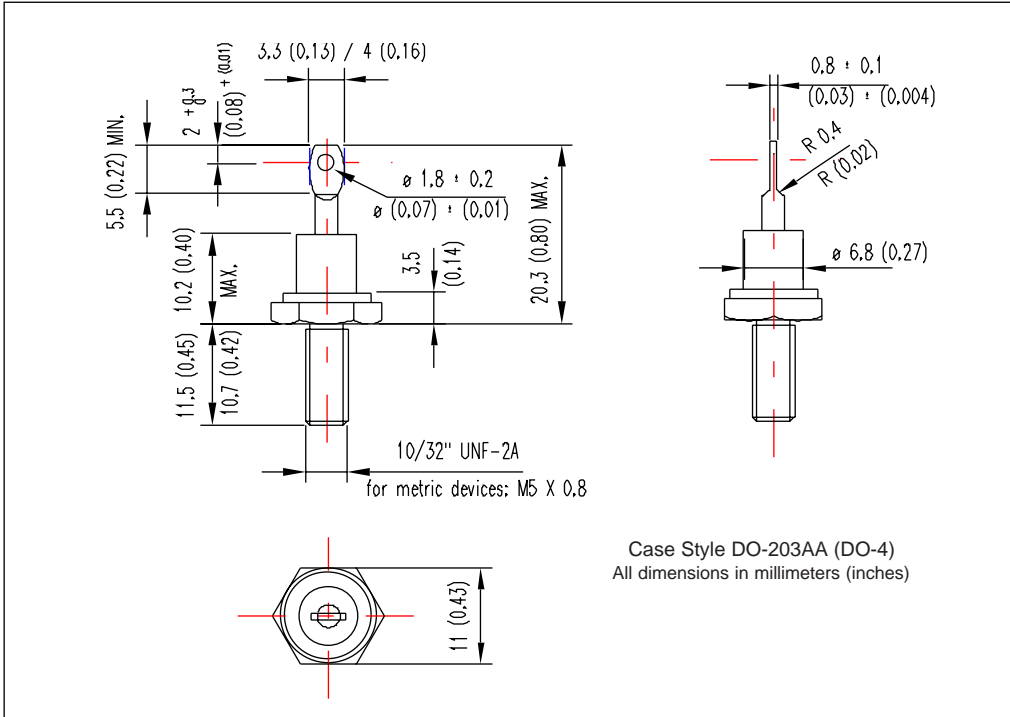

Fig. 1 - Current Ratings Characteristics

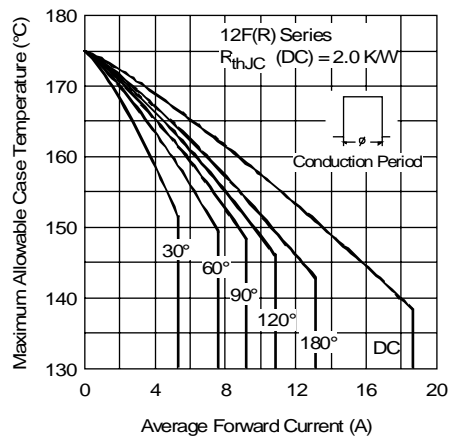

Fig. 2 - Current Ratings Characteristics

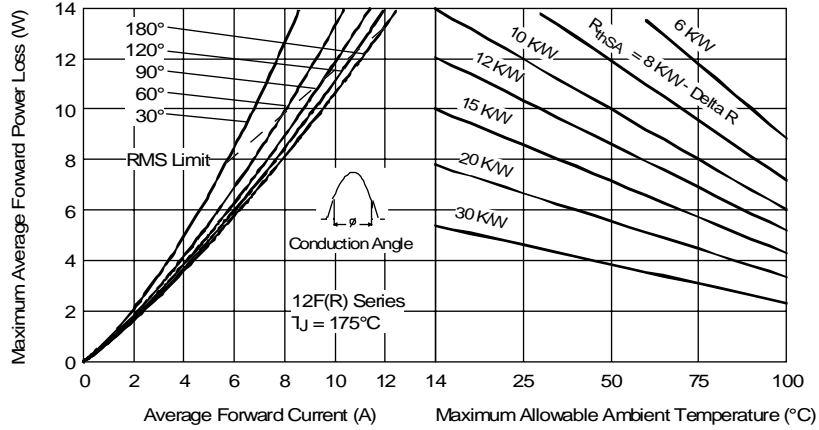

Fig. 3 - Forward Power Loss Characteristics

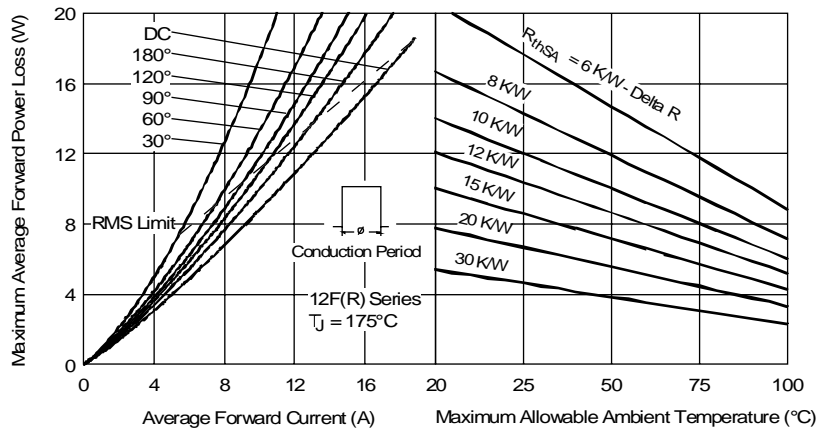

Fig. 4 - Forward Power Loss Characteristics

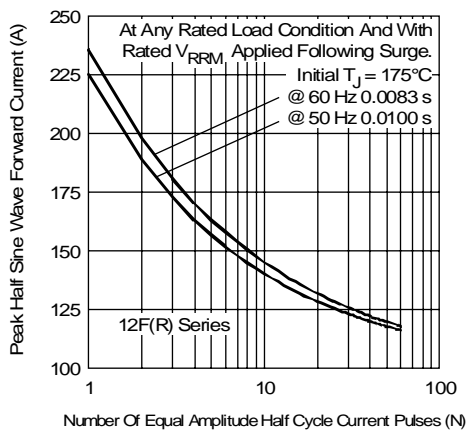

Fig. 5 - Maximum Non-Repetitive Surge Current

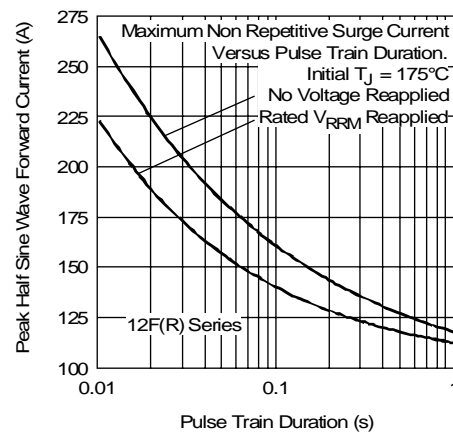

Fig. 6 - Maximum Non-Repetitive Surge Current

12F(R) Series

Bulletin I20205 rev. A 09/98

International
IR Rectifier

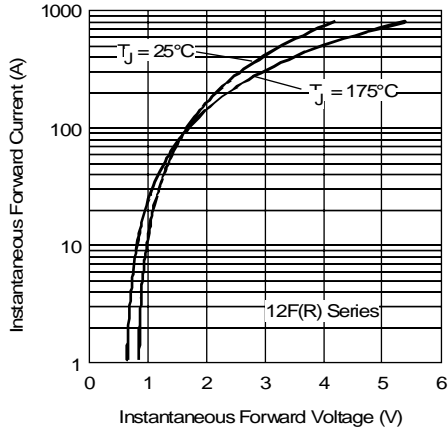

Fig. 7 - Forward Voltage Drop Characteristics

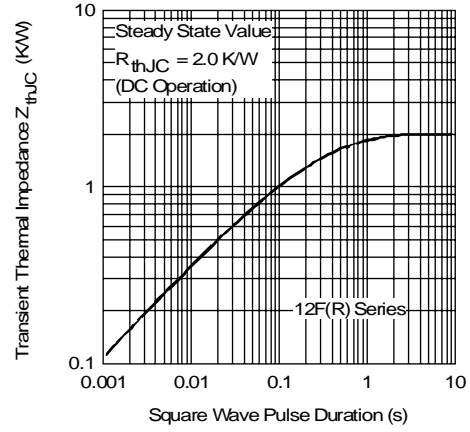

Fig. 8 - Thermal Impedance Z_{thJC} Characteristics

International
IR Rectifier

WORLD HEADQUARTERS: 233 Kansas St., El Segundo, California 90245 U.S.A. Tel: (310) 322 3331. Fax: (310) 322 3332.

EUROPEAN HEADQUARTERS: Hurst Green, Oxted, Surrey RH8 9BB, U.K. Tel: ++ 44 1883 732020. Fax: ++ 44 1883 733408.

IR CANADA: 15 Lincoln Court, Brampton, Markham, Ontario L6T3Z2. Tel: (905) 453 2200. Fax: (905) 475 8801.

IR GERMANY: Saalburgstrasse 157, 61350 Bad Homburg. Tel: ++ 49 6172 96590. Fax: ++ 49 6172 965933.

IR ITALY: Via Liguria 49, 10071 Borgaro, Torino. Tel: ++ 39 11 4510111. Fax: ++ 39 11 4510220.

IR FAR EAST: K&H Bldg., 2F, 30-4 Nishi-Ikebukuro 3-Chome, Toshima-Ku, Tokyo, Japan 171. Tel: 81 3 3983 0086.

IR SOUTHEAST ASIA: 1 Kim Seng Promenade, Great World City West Tower, 13-11, Singapore 237994. Tel: ++ 65 838 4630.

IR TAIWAN: 16 Fl. Suite D.207, Sec. 2, Tun Haw South Road, Taipei, 10673, Taiwan. Tel: 886 2 2377 9936.

<http://www.irf.com>

Fax-On-Demand: +44 1883 733420

Data and specifications subject to change without notice.