

**SINGLE CHIP “SPEAKERPHONE” WITH
8 - OHM LOUDSPEAKER AMPLIFIER**

1 Scope

This application note describes a low-cost add-on circuit for driving an 8Ω-Loudspeaker to get a simple loudhearing (“Speakerphone”) Telephone.

To possible ways of supplying the amplifier are shown:

SAN2202a:	Amplifier supply in shunt transistor path
SAN2202b:	Amplifier supply by power extraction circuit (SAN3020)

It can be added to any SA253x application without interfering with PTT-relevant parameters, like AC-impedance, Sidetone cancellation or DC-mask.

2 Key Features

- Low cost additional circuit enables use of loudhearing function
- Full duplex “handsfree” operation via handset microphone and loudspeaker (at distances <2m between telephone and user)
- Can be added to any SA253x- application
- Enables use of low cost 8Ω - Loudspeaker
- High output power with low distortion
- Entirely powered from the telephone line
- No influence of loudspeaker amplifier in AC-impedance, sidetone cancellation or DC-mask
- Loudspeaker volume adjustable by potentiometer
- Excellent sidetone cancellation of SAS253x circuits enables high loudspeaker volume without howling between handset microphone and loudspeaker

TABLE OF CONTENTS

1 SCOPE	1
2 KEY FEATURES	1
3 OTHER APPLICABLE DOCUMENTS AND PAPERS	3
4 REVISION STATUS	3
5 GENERAL DESCRIPTION	3
5.1 AMPLIFIER SUPPLY: COMPARISON OF SAN2202A AND SAN2202B:	3
6 BLOCK DIAGRAM	4
6.1 HOW TO AVOID HOWLING	4
7 CIRCUIT DESCRIPTION	5
7.1 8Ω LOUDSPEAKER AMPLIFIER.....	5
7.2 AMPLIFIER SUPPLY IN SHUNT TRANSISTOR PATH	5
7.3 AMPLIFIER SUPPLY BY POWER EXTRACTION CIRCUIT SAN3020	5
8 MEASUREMENT RESULTS & CURVES	6
8.1 FREQUENCY RESPONSE	6
8.2 MAXIMUM SENDING LEVEL	6
8.3 MAXIMUM OUTPUT POWER	6
8.4 ON-RESISTANCE IN PULSE DIALING	7
9 APPLICATION SCHEMATIC	8
10 LIABILITY AND COPYRIGHT STATEMENT	9



3 Other applicable documents and papers

1. Data Sheet SA2531/2 Single Chip Telephone
2. Application Note SAN3020: Power extraction for external loads

4 Revision status

SAN2202 Application Note (this document)

5 General description

The amplifier is a simple, low cost add-on circuit to the SA253x single chip telephone family. It is supplied by the line current and amplifies the receive signal, taken from either RO1 or RO2 (Receive outputs), see Fig.1.

Compared to more complex “real” handsfree circuits there is no channel switching or anti-larsen circuit implemented, therefore the receive and transmit gains must be lower to avoid howling.

However, at short distances between user and telephone (<2m, which is adequate for normal office work) there is even full duplex “handsfree” operation possible, when the handset is placed next to the telephone with the microphone facing to the user.

Due to the excellent sidetone cancellation of the SA253x circuits, howling between handset microphone and loudspeaker will only occur, when both are put very close to each other. In normal operation, no howling will occur, even with maximum loudspeaker volume.

Due to the unique structure of the SA253x family’s line adaption, adding the amplifier has no influence on the important PTT related parameters, like AC-impedance, DC-mask, etc. (see Pt. 5.1 below).

Note: all subsequent component numbering refers to the schematic, shown in Pt. 9

5.1 Amplifier supply: Comparison of SAN2202a and SAN2202b:

The following table describes the difference between the two types of amplifier supply: while the simple SAN2202a supply shows slight influence in maximum sending level and “Make”-resistance in pulse dialing , the SAN2202b (3 extra components) supply has no influence in these parameters and has a more stable maximum output driving capability at high line currents (see Fig.4 & 5).

Parameter	SAN2202a (Shunt path supply)	SAN2202b (Power extraction)
AC impedance	no influence	no influence
off -hook DC mask	no influence	no influence
Tx-/Rx-gains	no influence	no influence
“Make”-resistance in pulse dialing	<230Ω @ 20mA	<160Ω @20mA
max. sending level (soft clip level = 4Vpp)	no influence for $I_{Line} < 40mA$ <4Vpp for $I_{Line} > 40mA$ (see.Fig.3)	no influence ; soft clip level
max. 8Ω output power; THD <2%	≈26mW	≈27mW
max. 8Ω output power; THD <3%	≈32mW	≈34mW
number of extra components	none	3parts: 1 transistor,1diode,1resistor

6 Block diagram

Fig. 1 shows the block diagram of the speech paths: the transmitted signal is fed to the line via the 2-4 wire interface and the receive signal coming from line is fed to the Rx amplifier. The same Rx signal passes an attenuator for volume control and is then amplified by the loudspeaker amplifier.

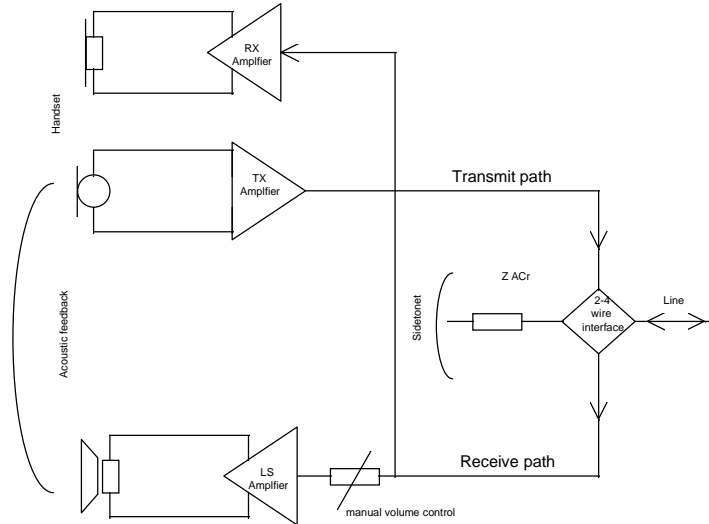

Fig. 1: speakerphone block diagram

6.1 how to avoid howling

As can be seen on Fig.1, there is an acoustic loop from

loudspeaker ⇒ acoustic feedback (determined by the mechanical distance between loudspeaker and handset microphone) ⇒ Tx amplifier ⇒ sidetone ⇒ LS amplifier.

Howling will occur, when the total loop gain is ≥ 1 (equal to $\geq 0\text{dB}$). Therefore the following conditions will have an effect in loop gain:

Parameter:	measure to reduce howling	Note:
Transmit gain	reduce gain	must meet the SLR limits
Sidetone	increase sidetone cancellation	can be done by optimizing the sidetone network, the better the sidetone cancellation, the more gain can be given to the loudspeaker
Loudspeaker volume	decrease loudspeaker volume	for good performance, a maximum of loudspeaker volume is desirable, therefore this should be the least step
Loudspeaker frequency response	limit bandwidth	howling will occur with the frequency of the highest amplification. Therefore the frequency response curve should be as flat as possible and limited to the speech band ($\approx 300..3400\text{Hz}$)
acoustic coupling between loudspeaker and handset microphone	increase distance between loudspeaker and handset microphone	In normal operation, the distance can be down to a few centimeters, when the handset is put onto or off the cradle. The loop should be adjusted such that in normal speech mode there is no howling at distances $>5..10\text{ cm}$. Additionally, the loudspeaker can be mounted away from the handset microphone position, like on the side or on the rear, if possible.

7 Circuit description

7.1 8Ω loudspeaker amplifier

The amplifier is a simple Class-A type amplifier. Gain is set by R6, the bandwidth is limited by CC4 (to avoid howling). Q4 and Q6 should be matched in gain (complementary types).

Nearly all the line current will flow through these transistors, independent of the signal output amplitude. The maximum power dissipation of Q4 and Q6 is

$$P_{\text{tot}} = V_{\text{CE}} * (I_{\text{Line}} - I_{\text{IC1}})$$

where: $V_{\text{CE,Q4}} = V_{\text{BE,Q4}} + U_{\text{D2}}$ and
 $V_{\text{CE,Q6}} = V_{\text{BE,Q6}} + U_{\text{D1}}$

$V_{\text{BE}}(\text{Q4,Q6}) \approx 0.7\text{V}$, $V_{\text{TH}}(\text{D2,D1}) \approx 0.52\text{V}$.
 $I_{\text{SA2531/2}} = \text{typ. } 3\text{mA}$ (see data sheet)

Power dissipation at $I_{\text{line}} = 100\text{mA}$: $P_{\text{tot}} = (0.7+0.52) * (0.1-0.003) = \underline{118\text{mW}}$

In order to maintain no interference of the circuit to AC-impedance, DC-mask, maximum sending level, etc..., the amplifiers' supply voltage V_{CC} must be limited to $<2.44\text{V}$ ¹⁾.

This is accomplished by

$$V_{\text{CC}} = V_{\text{BE}}(\text{Q6}) + V_{\text{TH}}(\text{D1}) + V_{\text{TH}}(\text{D2}) + V_{\text{BE}}(\text{Q4}) .$$

$$V_{\text{CC}} = 0.68\text{V} + 0.5\text{V} + 0.5\text{V} + 0.68\text{V} = \underline{2.36\text{V}}$$

¹⁾ Critical for SAN2202a configuration, not critical for SAN2202b configuration.

VLI can range between 2.5...6.5V $\Rightarrow 4.5\text{V} \pm 2V_{\text{peak}}$ (max. sending level),
 the C-E saturation voltage of Q3 is assumed $>60\text{mV}$

To maintain full transmit swing ($\pm 2V_{\text{peak}}$) $\Rightarrow V_{\text{C}}(\text{Q3}) = V_{\text{CC}} = (2.5\text{V}-60\text{mV}) < \underline{2.44\text{V}}$

Transistor Q1, R1, R2 and R3 forms an impedance matching circuit to provide better matching between the receive output of the IC and the output amplifier stage.

7.2 Amplifier supply in shunt transistor path

This configuration requires no extra components. However, the maximum voltage of V_{PP} must be considered: If V_{PP} rises $>2.44\text{V}$, the maximum transmit level will be slightly distorted at the negative half-wave.

Additionally, the "Make"-resistance in pulse dialing will be higher, because with CS being pulled to V_{SS} , V_{LI} cannot be shorted to V_{BE} (as in the standard application AN1500 with the collector of Q3 being connected to V_{SS}).

During pulse dialing, VLI will be $\approx 2.5\text{V}$, thus increasing the total "ON"-resistance by

$$\Delta R_{\text{ON}} = \frac{2.5\text{V} - 0.6\text{V}}{I_{\text{Line}} - 3\text{mA}} = \underline{\underline{11\Omega(20\text{mA}) \dots 19.6\Omega(100\text{mA})}}$$

7.3 Amplifier supply by power extraction circuit SAN3020

This power extraction can be used to supply any external load by the available line current without affecting the performance of the single chip telephone. A detailed description of this circuit is given in application note SAN3020. "ON"-resistance in pulse dialing (compared to the standard application AN1500) is only increased by $\approx 10\Omega$ (see Fig. 6).



8 Measurement results & curves

8.1 Frequency response

Fig. 2 shows the frequency response curve of the loudspeaker amplifier. The curve shows the output level on an 8Ω resistor (solid line) and an 8Ω loudspeaker (dotted line; PHILIPS AD3371 series 80mmØ 8Ω speaker) measured with maximum volume and -10dBm Rx level on line. The peak at 200Hz is a resonant frequency of the specific loudspeaker type.

Gain of the amplifier is set by the resistors R6 and the attenuation of VR1. The bandwidth is adjusted by CC4.

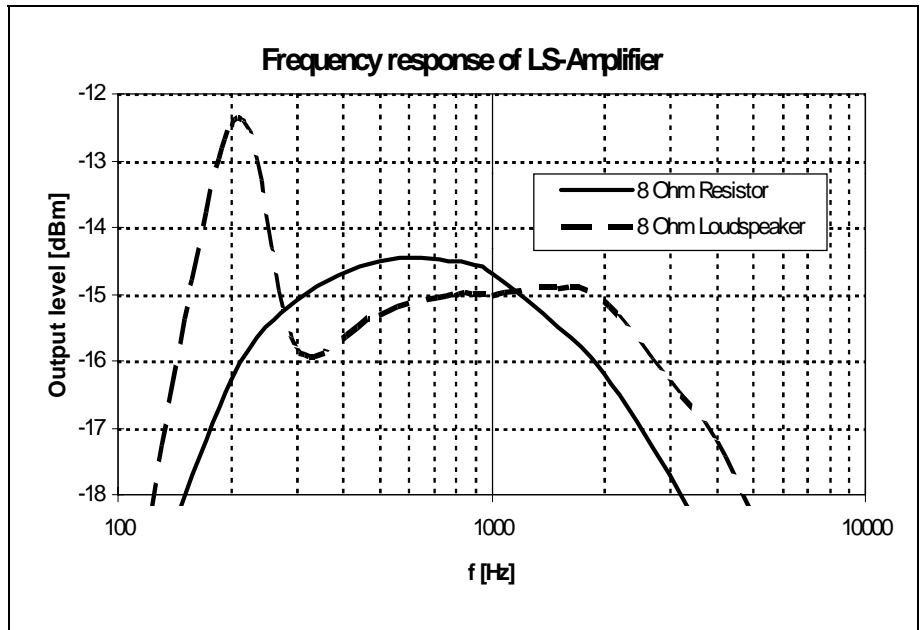

Fig. 2: Frequency response of loudspeaker amplifier ($P_{Line} = -10dBm$)

8.2 maximum sending level

Fig.3 shows the maximum Transmit sending level, measured at LI vs. line current, assuming a total harmonic distortion (THD) of less than 1%.

AN2201a (dotted line): At line currents >40mA, VPP will rise up to 2.5V (@ 90mA) and sending level will be slightly distorted before it reaches the soft clip level ($\pm 2V_{peak}$).

AN2202b (solid line): There is no influence in maximum sending level, the transmit signal can be up to the soft clip level at line currents of >12mA.

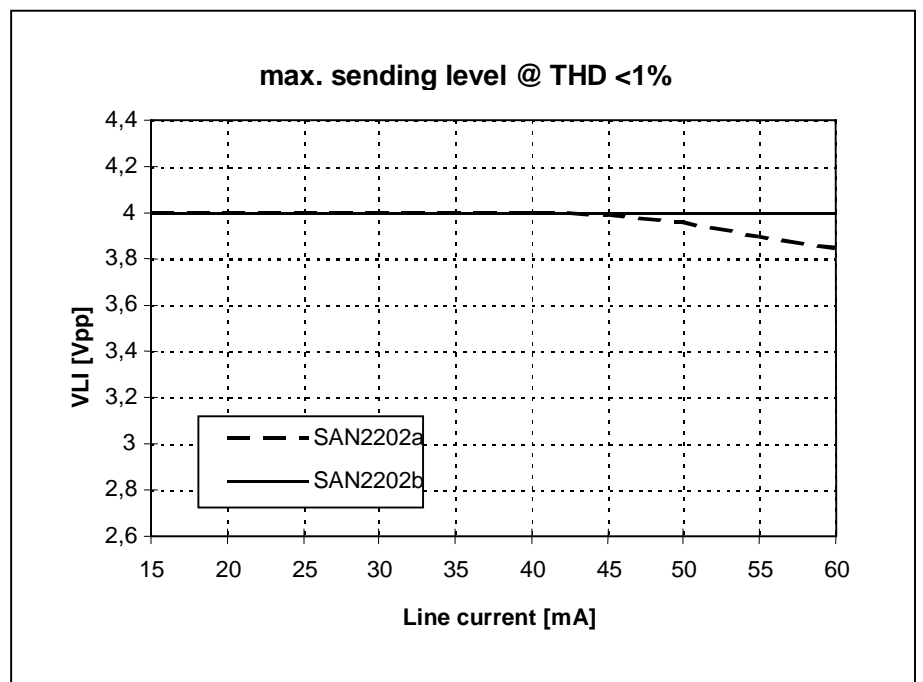

Fig. 3: maximum sending level vs. line current (@ THD <1%)

8.3 maximum output power

Fig.4 and Fig.5 show the maximum output power on an 8Ω loudspeaker at f=1kHz: the curves indicate the maximum output power with <2% and <3% total harmonic distortion.

SAN2202a: The lower output drive capability at higher line currents results from nonlinearities at higher collector currents and mismatch in the complementary transistor types.

SAN2202b: Maximum output power is not decreased with higher line currents.

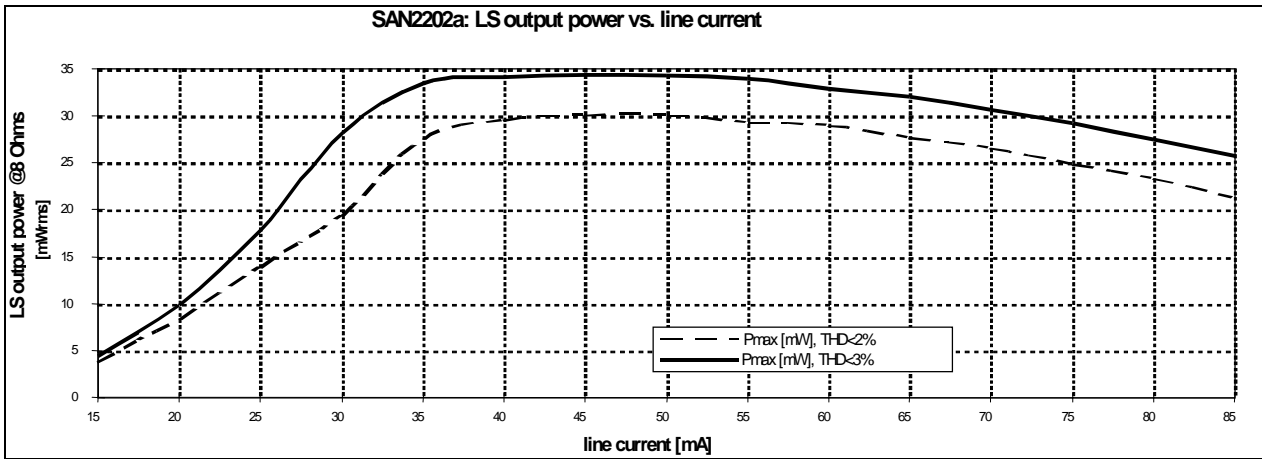

Fig. 4: SAN2202a: maximum output power on 8Ω loudspeaker vs. line current, f=1kHz

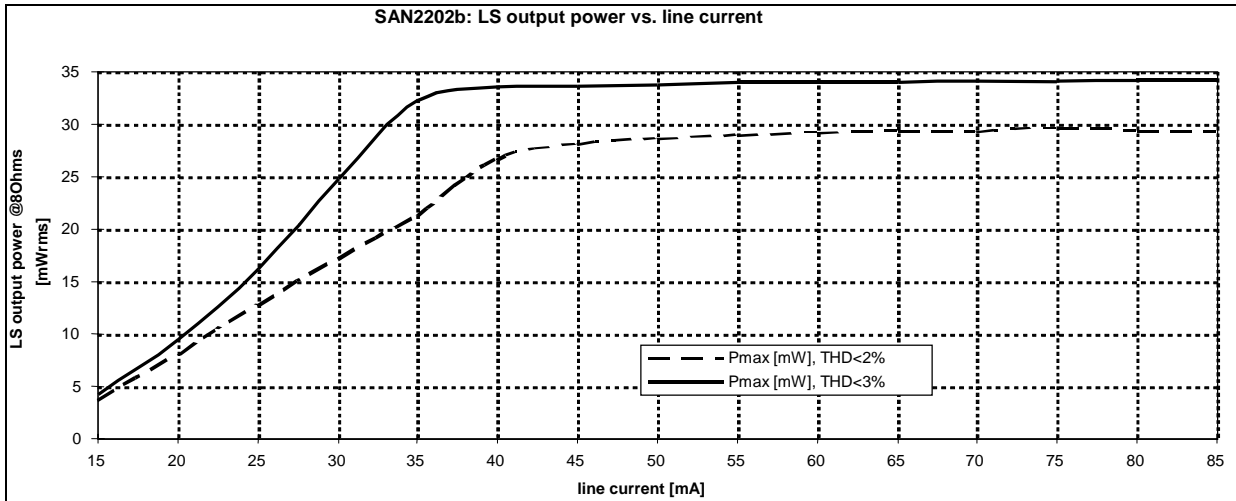

Fig. 5: SAN2202b: maximum output power on 8Ω loudspeaker vs. line current, f=1kHz

8.4 On-resistance in pulse dialing

As described in Pt. 7.2 and 7.3, the ON-resistance (=“Make”-resistance) in both applications is higher than with the standard application, AN1500. However, the ON-resistance in pulse dialing is generally low with SA253x - applications, this parameter allows a wide tolerance to meet the PTT specs. Germany’s BAPT223 ZV5, for example, allows $RON \leq 390\Omega @ I_{Line} > 24mA$.

Fig. 6 shows the ON-resistance ,measured on a-and b-terminals in pulse dialing with the SAN2202 applications compared to the standard application SAN2201.

Note: since the measurement is taken at a- and b-terminals, the overall resistance including ON-resistance of line-transistor) will be measured.

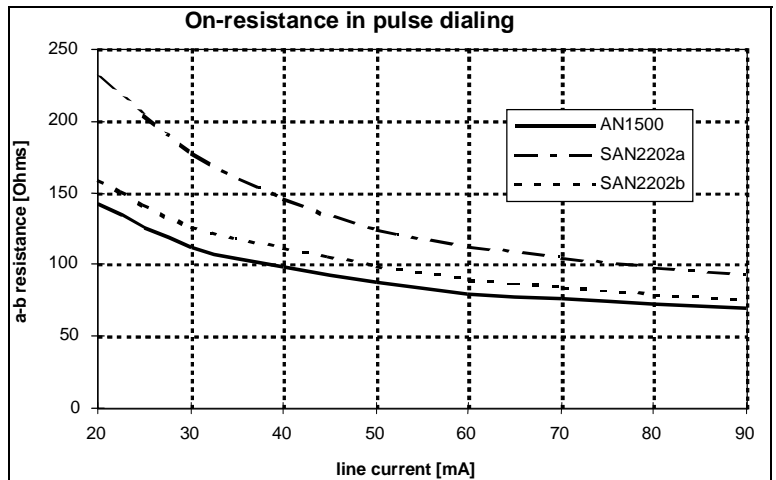
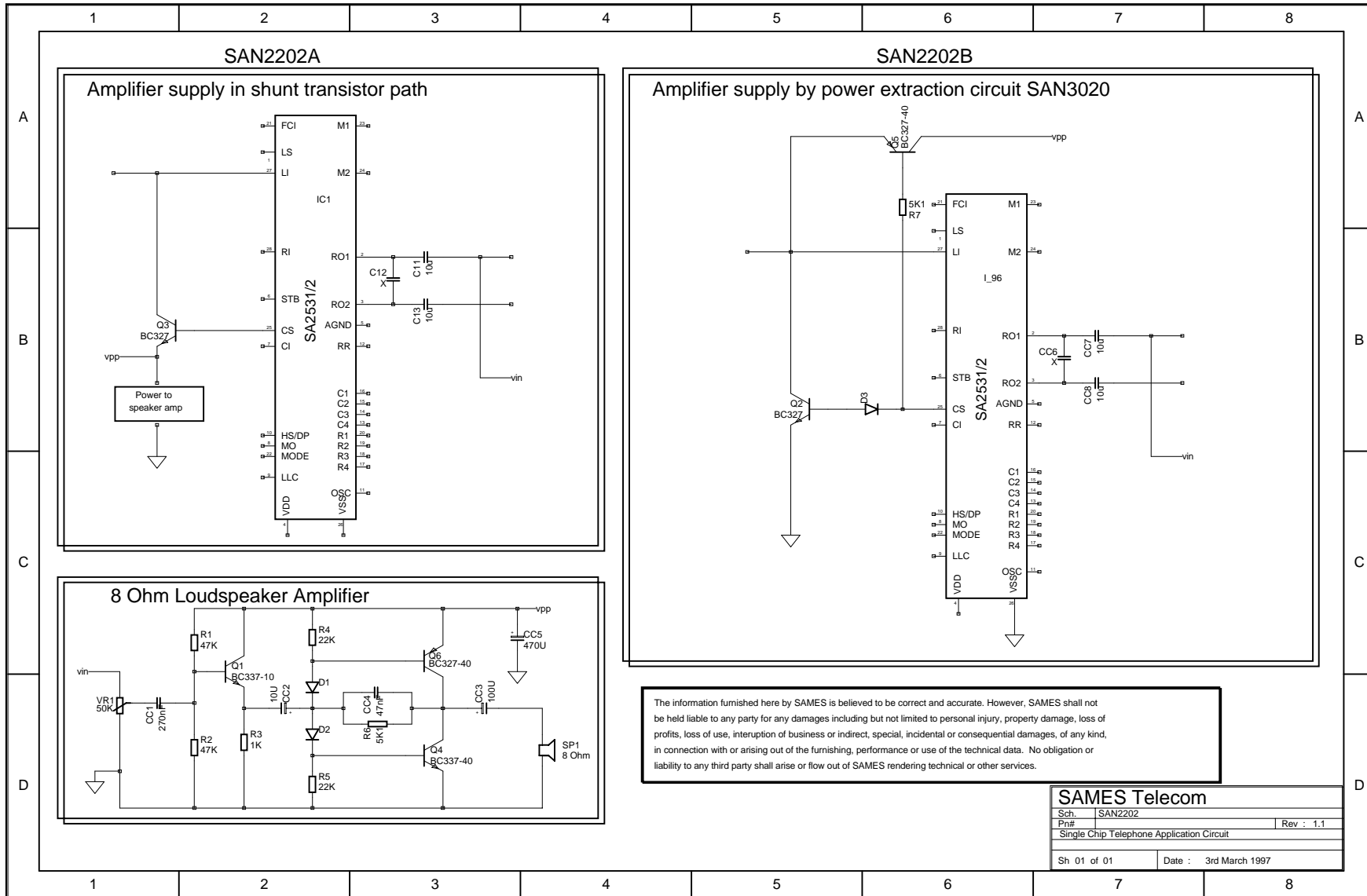

Fig. 6: On-resistance in pulse dialing with SAN2201, SAN2202a and -b

9 Application schematic



10 Liability and Copyright Statement

Disclaimer: The information contained in this document is confidential and proprietary to South African Micro-Electronic Systems (Pty) Ltd ("SAMES") and may not be copied or disclosed to a third party, in whole or in part, without the express written consent of SAMES. The information contained herein is current as of the date of publication; however, delivery of this document shall not under any circumstances create any implication that the information contained herein is correct as of any time subsequent to such date. SAMES does not undertake to inform any recipient of this document of any changes in the information contained herein, and SAMES expressly reserves the right to make changes in such information, without notification, even if such changes would render information contained herein inaccurate or incomplete. SAMES makes no representation or warranty that any circuit designed by reference to the information contained herein, will function without errors and as intended by the designer.

South African Micro-Electronic Systems (Pty) Ltd

P O Box 15888,
Lynn East,
0039
Republic of South Africa,

33 Eland Street,
Koedoespoort Industrial Area,
Pretoria,
Republic of South Africa

Tel: 012 333-6021
Fax: 012 333-3158

Tel: Int +27 12 333-6021
Fax: Int +27 12 333-3158

Web Site : <http://www.sames.co.za>

