

Converter thyristor Type N1483xx36xxx to N1483xx42xxx

Absolute maximum ratings

	VOLTAGE RATINGS	MAXIMUM LIMITS	UNITS
V_{DRM}	Repetitive peak off-state voltage, (note 1).	3600-4200	V
V_{DSM}	Non-repetitive peak off-state voltage, (note 1).	3600-4200	V
V_{RRM}	Repetitive peak reverse voltage, (note 1).	3600-4200	V
V_{RSM}	Non-repetitive peak reverse voltage, (note 1).	3700-4300	V

	RATINGS	MAXIMUM LIMITS	UNITS
$I_{T(AV)}$	Mean on-state current, $T_{sink}=55^{\circ}C$, (note 2).	3400	A
$I_{T(AV)}$	Mean on-state current. $T_{sink}=85^{\circ}C$, (note 5).	2400	A
$I_{T(AV)}$	Mean on-state current. $T_{sink}=85^{\circ}C$, (note 3).	1500	A
$I_{T(RMS)}$	Nominal RMS on-state current, $25^{\circ}C$, (note 2).	6650	A
$I_{T(d.c.)}$	D.C. on-state current, $25^{\circ}C$, (note 7).	5950	A
I_{TSM}	Peak non-repetitive surge $t_p=10ms$, $V_{RM}=0.6V_{RRM}$, (note 4).	54.0×10^3	A
I_{TSM2}	Peak non-repetitive surge $t_p=10ms$, $V_{RM} \leq 10V$, (note 4).	60.0×10^3	A
I^2t	I^2t capacity for fusing $t_p=10ms$, $V_{RM}=0.4V_{RRM}$, (note 4).	12.2×10^6	A^2s
I^2t	I^2t capacity for fusing $t_p=10ms$, $V_{RM} \leq 10V$, (note 4).	15.1×10^6	A^2s
I^2t	I^2t capacity for fusing $t_p=3ms$, $V_{RM} \leq 0.4V_{RRM}$, (note 4).	10.1×10^6	A^2s
di/dt	Critical rate of rise of on-state current (continuous), (note 6).	150	$A/\mu s$
di/dt	Critical rate of rise of on-state current (Intermittent), (note 6).	300	$A/\mu s$
I_{FGM}	Peak forward gate current.	10	A
V_{RGM}	Peak reverse gate voltage.	5	V
$P_{G(AV)}$	Mean forward gate power.	5	W
P_{GM}	Peak forward gate power.	30	W
V_{GD}	Non-trigger gate voltage, (Note 5).	0.25	V
T_{HS}	Operating temperature range.	-40 to +125	$^{\circ}C$
T_{stg}	Storage temperature range.	-40 to +150	$^{\circ}C$

Notes:-

- 1) De-rating factor of 0.13% per K is applicable for T_j below $25^{\circ}C$.
- 2) Doubleside cooled, single phase; 50Hz, 180° half-sinewave.
- 3) Singleside cooled, single phase; 50Hz, 180° half-sinewave.
- 4) Half-sinewave, $125^{\circ}C$ T_j initial.
- 5) Rated V_{DRM} .
- 6) $V_D=67\%V_{DRM}$, $I_T=6000A$, $I_{FG}=2A$, $t_r=500ns$.
- 7) Doubleside cooled.

Characteristics

	CHARACTERISTICS	MIN	TYP	MAX	TEST CONDITIONS	UNITS
V_{TM}	Maximum peak on-state voltage.	-	-	1.87	$I_T=6000A$.	V
V_0	Threshold voltage.	-	-	0.85		V
R_T	Slope resistance.	-	-	0.17		m Ω
dv/dt	Critical rate of rise of off-state voltage.	200	1000	2000	$V_D=80\% V_{DRM}$.	V/ μ s
I_{DRM}	Peak off-state current.	-	-	250	Rated V_{DRM} note 2.	mA
I_{RRM}	Peak reverse current.	-	-	250	Rated V_{RRM} note 2.	mA
V_{GT}	Gate trigger voltage	-	-	3.0	$T_J=25^\circ C$.	V
I_{GT}	Gate trigger current	-	-	300	$T_J=25^\circ C$. $V_D=10V$, $I_A=3A$	mA
I_H	Holding current	-	-	1000	$T_J=25^\circ C$.	mA
R_θ	Thermal resistance junction to sink.	-	-	9	Double side cooled.	K/KW
		-	-	18	Single side cooled.	K/KW
F	Mounting force.	81	-	98		kN
W_t	Weight.	-	2.80	-		kg

Notes:-

- 1) Unless otherwise indicated $T_J=125^\circ C$.
- 2) Leakage current limit, this will be increased in the future to 400mA

Notes on Ratings and Characteristics

1 Voltage Grade Table

Voltage Grade 'H'	V_{DSM} V_{DRM} V_{RRM} V	V_{RSM} V	V_D V_R V_{DC}
36	3600	3700	2000
37	3700	3800	2050
38	3800	3900	2100
39	3900	4000	2150
40	4000	4100	2200
41	4100	4200	2250
42	4200	4300	2300

2 Extension of Voltage Grades

This report is applicable to other and higher voltage grades when supply has been agreed by Sales/Production.

3 De-rating Factor

A blocking voltage de-rating factor of 0.13% per °C is applicable to this device for T_J below 25 °C.

4 Repetitive dv/dt

Higher dv/dt selections are available up to 2000V/μs on request.

5 Computer modelling parameters

5.1 Device dissipation calculations

$$I_{AV} = \frac{-V_o + \sqrt{V_o^2 + 4 \cdot ff^2 \cdot r_s \cdot W_{AV}}}{2 \cdot ff^2 \cdot r_s}$$

Where $V_o = 0.850V$, $r_s = 0.170m\Omega$

$$W_{AV} = \frac{\Delta T}{R_{th}} \quad \Delta T = T_{jMax} - T_{Hs}$$

R_{th} = Supplementary thermal impedance, see table below.

ff = Form factor, see table below.

Supplementary Thermal Impedance (at 50Hz operating frequency)				
Conduction Angle	6 phase (60°)	3 phase (120°)	Half wave (180°)	d.c.
Square wave Double Side Cooled	0.0098	0.0095	0.0093	0.0090
Square wave Single Side Cooled	0.0196	0.0190	0.0186	0.0180
Sine wave Double Side Cooled	0.0096	0.0093	0.0090	
Sine wave Single Side Cooled	0.0196	0.0186	0.0180	

Form Factors				
Conduction Angle	60°	120°	180°	d.c.
Square wave	2.45	1.73	1.41	1
Sine wave	2.78	1.88	1.57	

5.2 Calculating V_T using ABCD coefficients

The on-state characteristic I_T vs V_T , on Fig. 9, is represented in two ways; (i) the well established V_0 and r_S tangent and (ii) a set of constants A, B, C, D, forming the coefficients of the representative equation for V_T in terms of I_T given below:

$$V_T = A + B \cdot \ln(I_T) + C \cdot I_T + D \cdot \sqrt{I_T}$$

The constants, derived by curve fitting software, are given in this report for both hot and cold characteristics where possible. The resulting values for V_T agree with the true device characteristic over a current range, which is limited to that plotted.

125°C Coefficients		25°C Coefficients	
A	1.24×10^{00}	A	1.17×10^{00}
B	-1.25×10^{-01}	B	-1.42×10^{-02}
C	3.81×10^{-05}	C	1.25×10^{-04}
D	1.87×10^{-02}	D	8.03×10^{-04}

5.3 D.C. Thermal impedance calculation

$$r_t = \sum_{p=1}^{p=n} r_p \left(1 - e^{-\frac{t}{\tau_p}} \right)$$

Where $p = 1$ to n , n is the number of terms in the series.

t = Duration of heating pulse in seconds.

r_t = Thermal resistance at time t .

r_p = Amplitude of p_{th} term.

τ_p = Time Constant of r_{th} term.

D.C. Double Side Cooled			
Term	1	2	3
r_p	4.06E-03	2.91E-03	1.92E-03
τ_p	1.42E+00	2.92E-01	3.16E-02

D.C. Single Side Cooled			
Term	1	2	3
r_p	1.2E-02	5.10E-03	9.95E-04
τ_p	1.23E+01	2.88E-01	8.57E-04

Curves

Figure 1, Maximum on-state characteristic

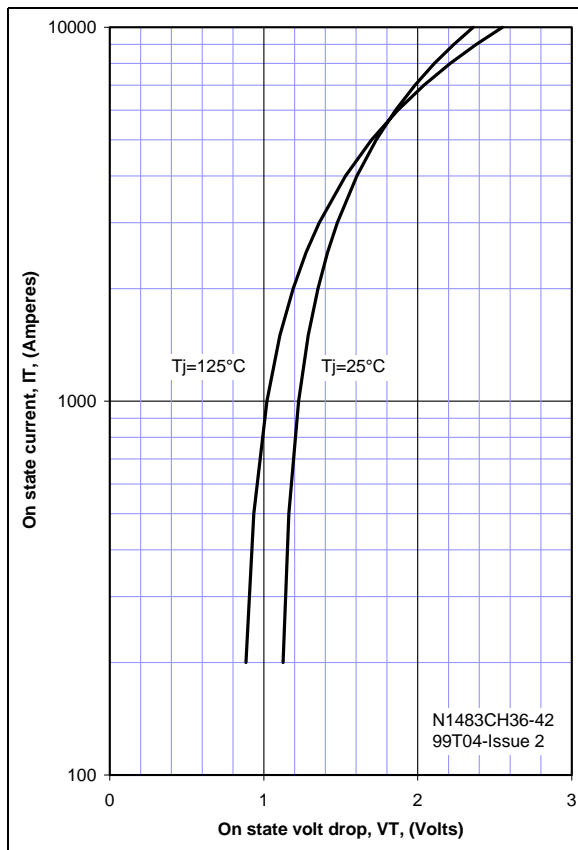

Figure 2, Transient thermal impedance

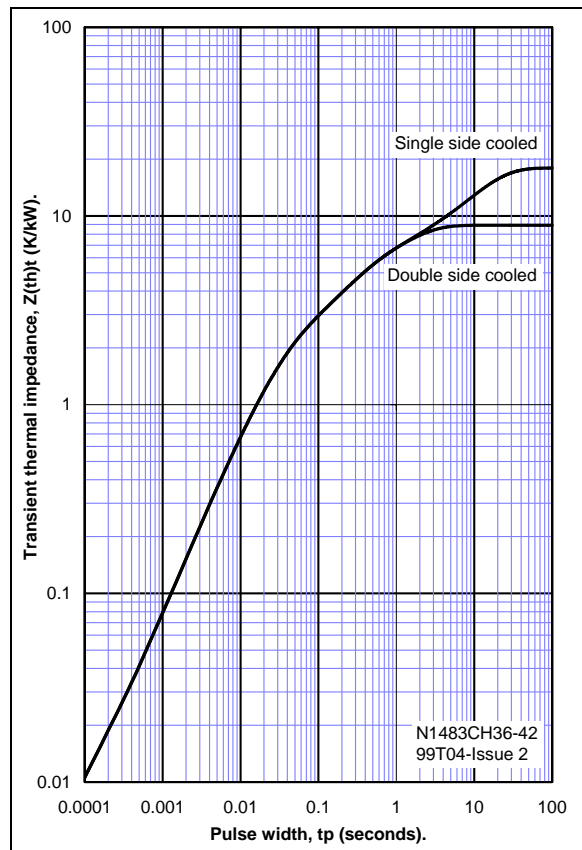

Figure 3, Maximum non repetitive surge

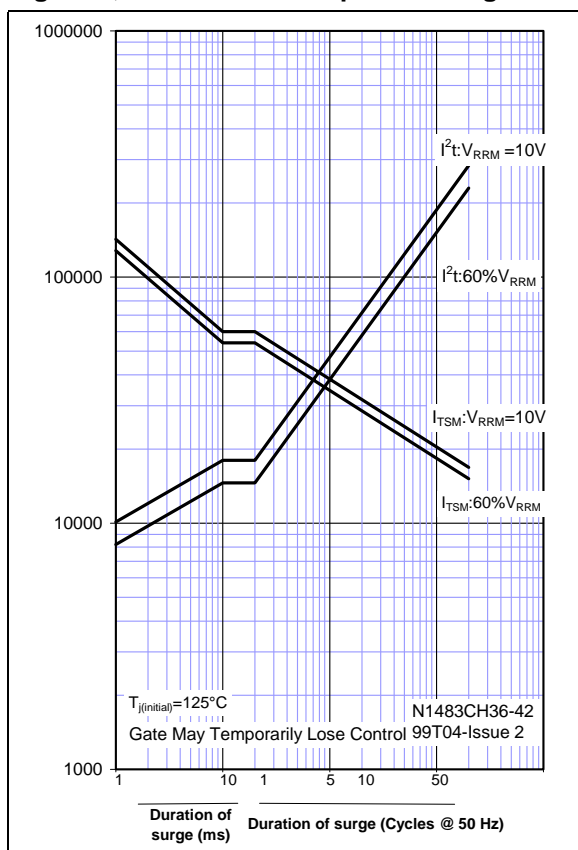

Figure 4, Gate characteristics, 25°C

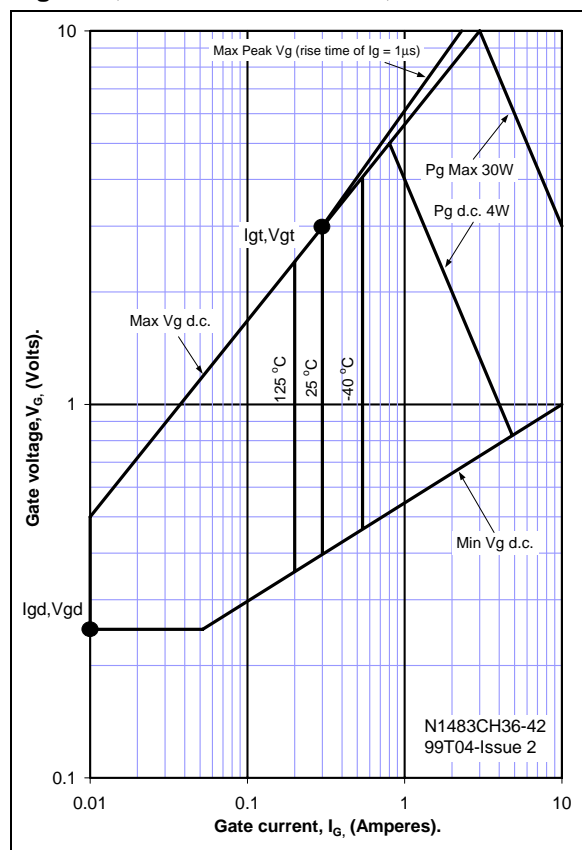

Figure 5, Power dissipation vs. mean current, sinewave, double side cooled

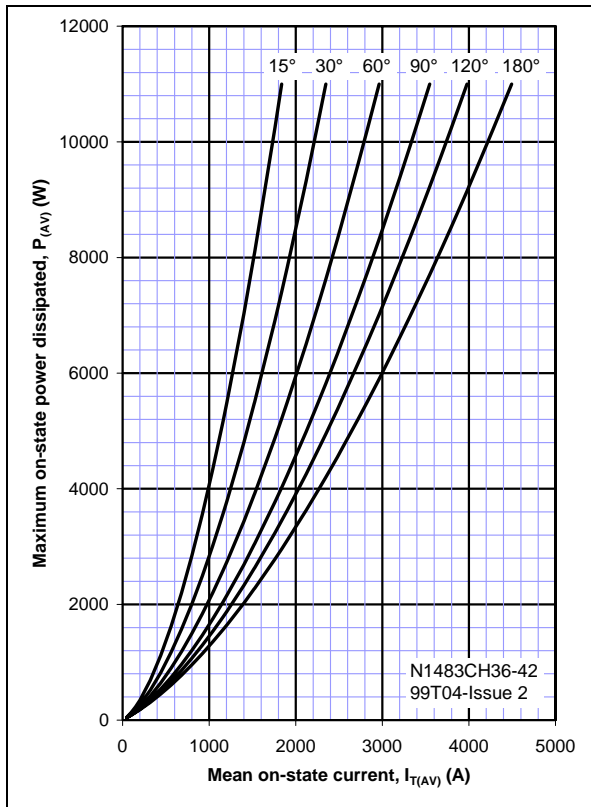

Figure 6, Power dissipation vs. mean current, sinewave, single side cooled

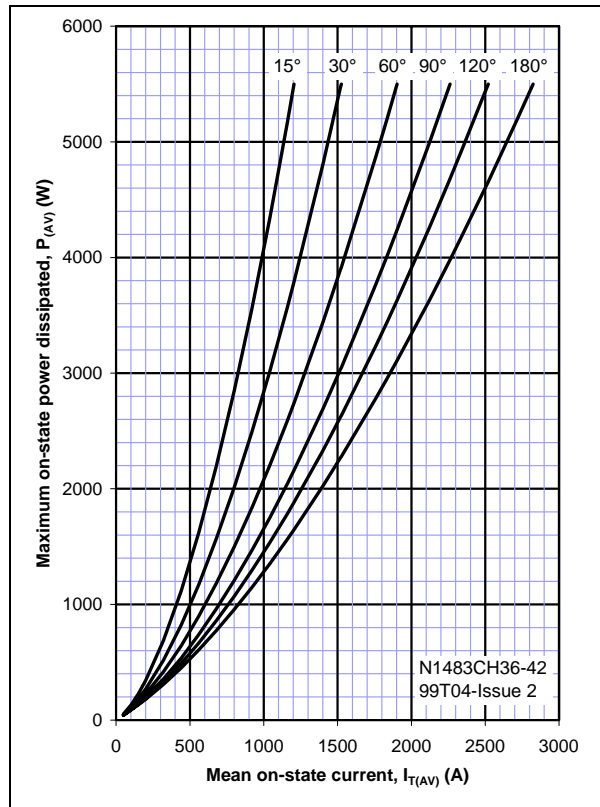

Figure 7, Heatsink temperature vs. mean current, sinewave, double side cooled

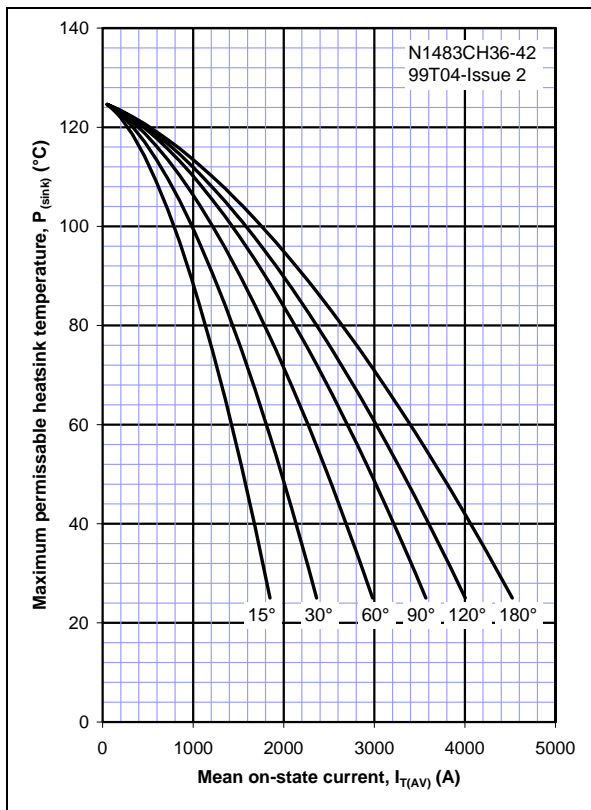

Figure 8, Heatsink temperature vs. mean current, sinewave, single side cooled

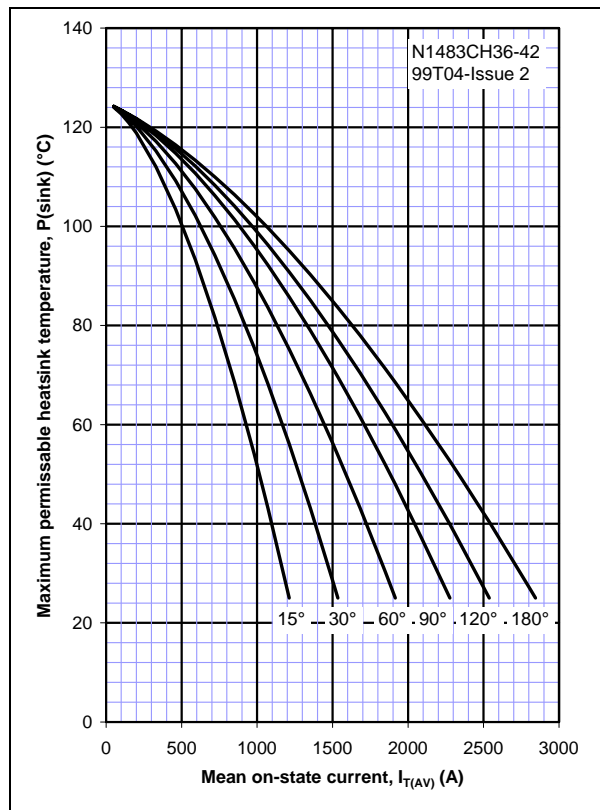

Figure 9, Power dissipation vs. mean current, squarewave, double side cooled

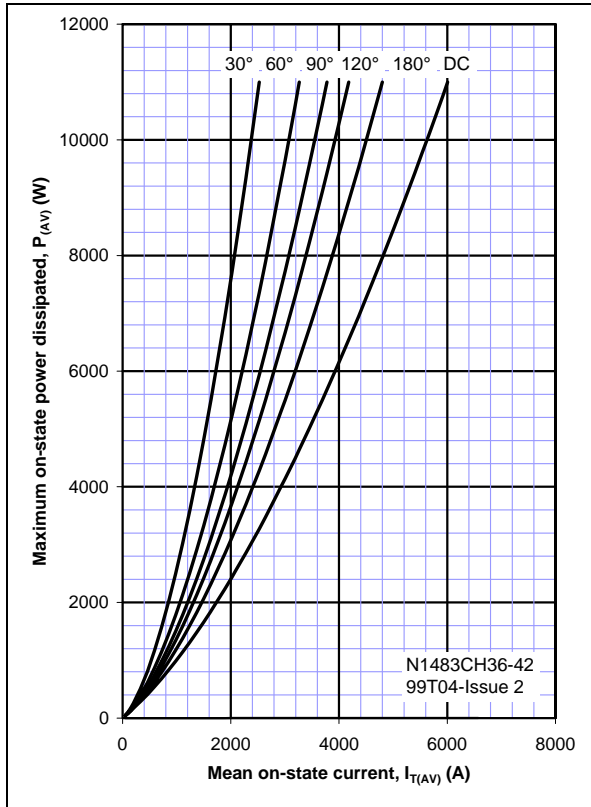

Figure 10, Power dissipation vs. mean current, squarewave, single side cooled

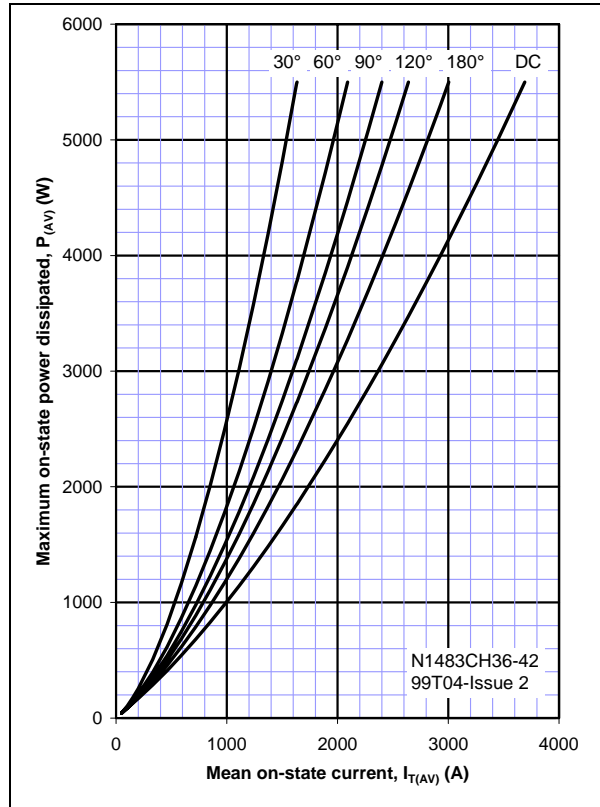

Figure 11, Heatsink temperature vs. mean current, squarewave, double side cooled

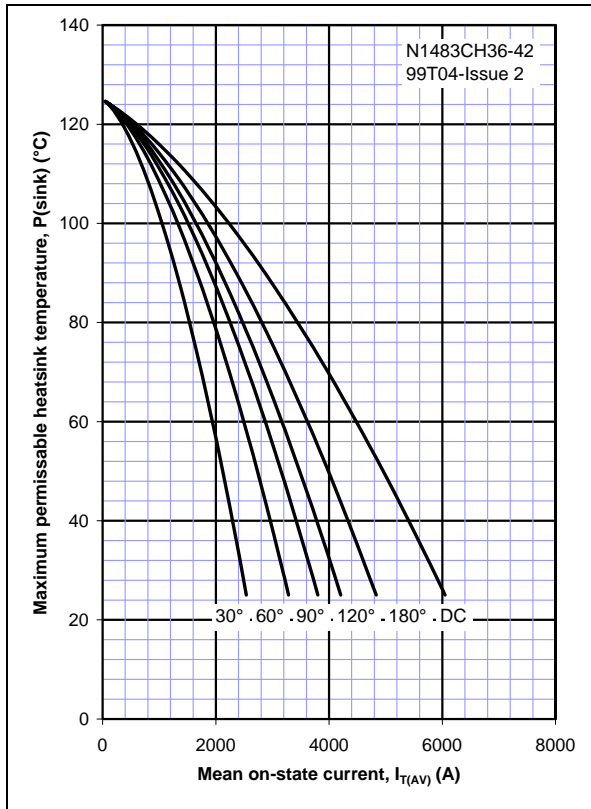
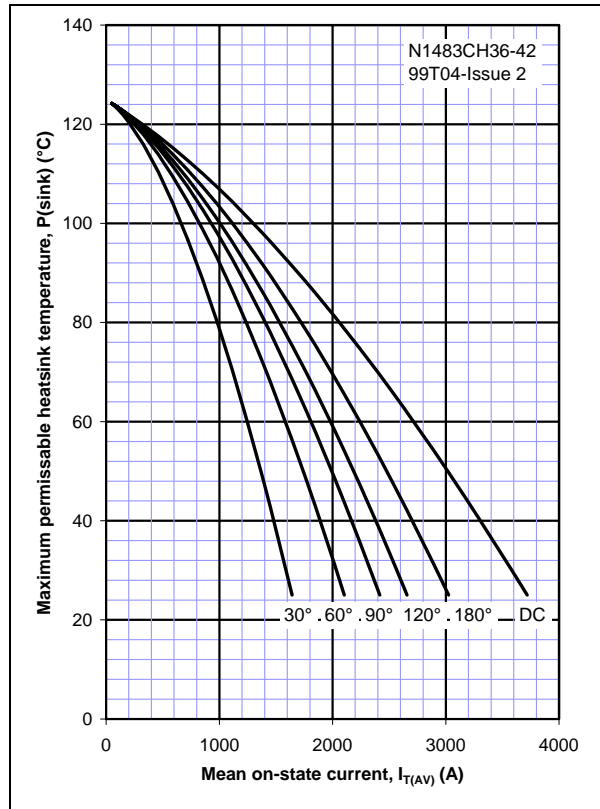
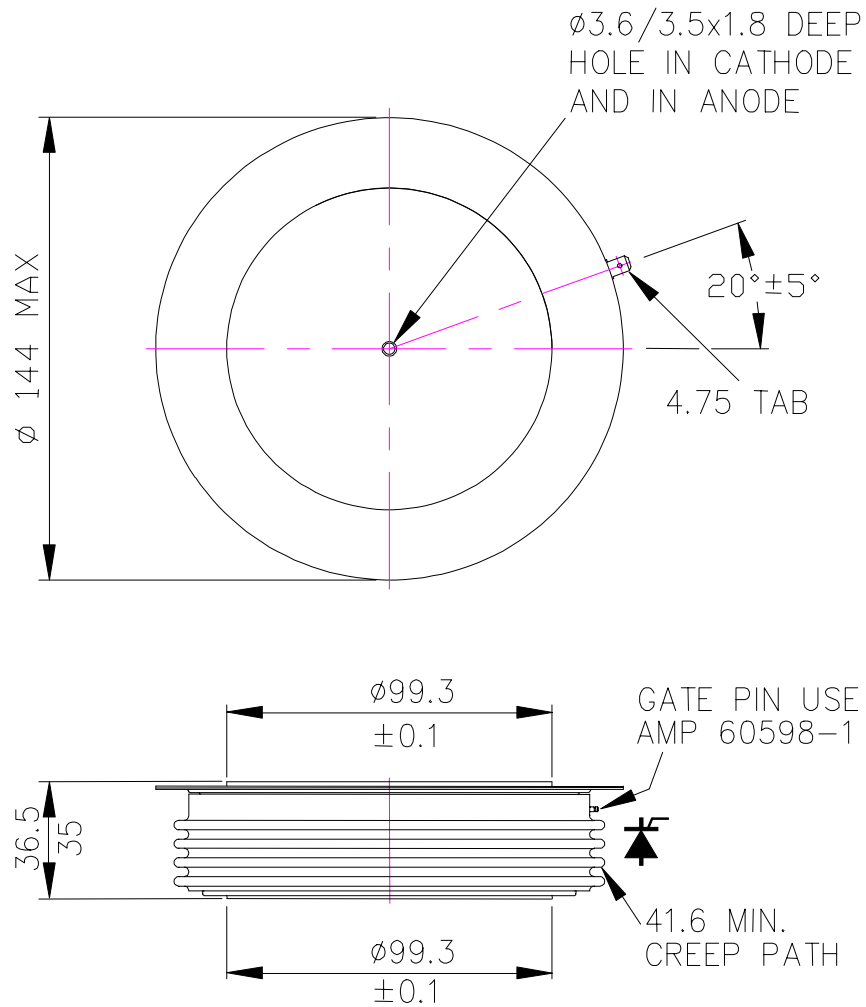

Figure 12, Heatsink temperature vs. mean current, squarewave, single side cooled



Outline drawing & ordering information



101A322

ORDERING INFORMATION

(Please quote 12 digit code as below)

N1283	C	◆	◆◆	◆◆◆	
Fixed Type Code	Outline Code		Voltage Code $V_{DRM} / 100$	dv/dt Code	
		H – standard explosion Z – enhanced explosion		Blank = 200V/ μ s JOO = 500V/ μ s	G00 = 300V/ μ s KOO = 750V/ μ s

Typical order code : N1483CZ42 – 4.2kV V_{DRM} , enhanced explosion rating capsule thyristor

WESTCODE

<http://www.westcode.com>

U.K: Westcode Semiconductors Ltd
 P.O. Box 57, Chippenham, England SN15 1JL
 Tel: +44 (0)1249444524 Fax: +44 (0)1249 659448
 E-mail: WSL.sales@westcode.com

USA: Westcode Semiconductors Inc
 3270 Cherry Avenue, Long beach, California 90807
 Tel: 562 595 6971 Fax: 562 595 8182