

SuperFlux LEDs

Introduction

This revolutionary package design allows the lighting designer to reduce the number of LEDs required and provide a more uniform and unique illuminated appearance than with other LED solutions. This is possible through the efficient optical package design and high-current capabilities.

The low profile package can be easily coupled with reflectors or lenses to efficiently distribute light and provide the desired lit appearance. This product family employs the world's brightest red, red-orange, amber, blue, cyan, and green LED materials, which allow designers to match the color of many lighting applications like vehicle signal lamps, specialty lighting, and electronic signs.

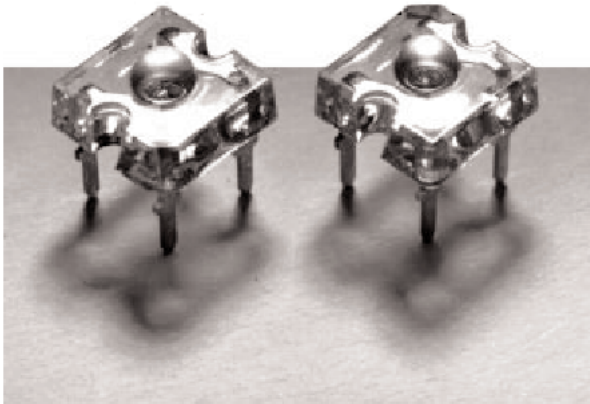

HPWA-MH00
HPWT-MH00
HPWA-DH00
HPWT-DH00
HPWT-RD00
HPWT-BH00
HPWT-MD00
HPWT-RL00
HPWT-DD00
HPWT-ML00
HPWT-BD00
HPWT-DL00
HPWT-RH00
HPWT-BL00
HPWN-MB00
HPWN-MC00
HPWN-MG00

Key Benefits

- ◆ Rugged Lighting Products
- ◆ Electricity Savings
- ◆ Maintenance Savings

Features

- ◆ High Luminance
- ◆ Uniform Color
- ◆ Low Power Consumption
- ◆ Low Thermal Resistance
- ◆ Low Profile
- ◆ Meets SAE/ECE/JIS Automotive Color Requirements
- ◆ Packaged in tubes for use with automatic insertion equipment

Typical Applications

- ◆ Automotive Exterior Lighting
- ◆ Electronic Signs and Signals
- ◆ Specialty Lighting

Outline Drawings

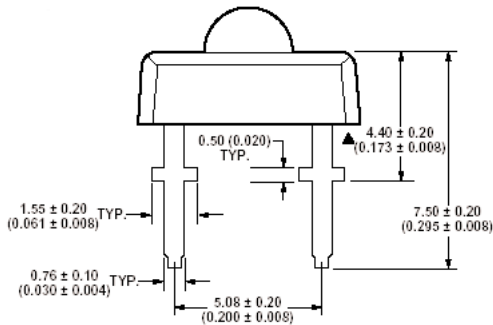
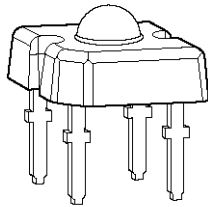
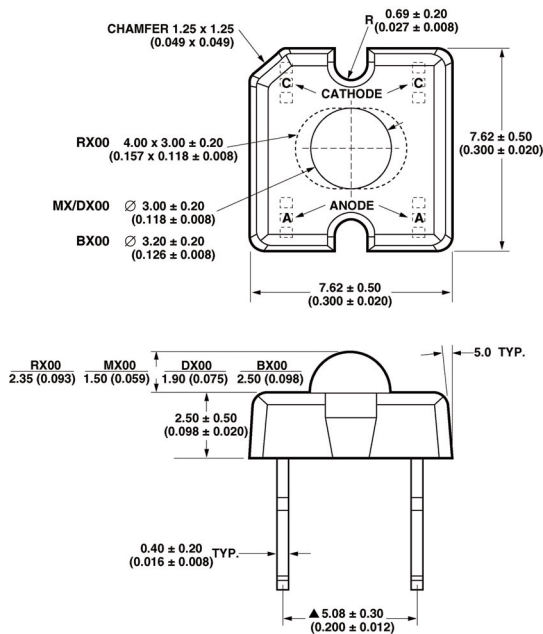

Selection Guide

Table 1

Device Type	LED Color	Total Flux Φ_V (LM) @ 70 mA ^[1] (HPWA, HPWT) 50 mA (HPWN)		Total Included Angle θ_{90V} (Degrees) ^[2]
		Typ.	Typ.	
HPWA-MH00	AS AlInGaP Red-Orange	2.0		95
HPWA-DH00				75
HPWT-RD00				44 X 88
HPWT-MD00	TS AlInGaP Red	3.8		100
HPWT-DD00				70
HPWT-BD00				50
HPWT-RH00				44 X 88
HPWT-MH00	TS AlInGaP Red-Orange	5.0		100
HPWT-DH00				70
HPWT-BH00				50
HPWT-RL00				44 X 88
HPWT-ML00	TS AlInGaP Amber	2.5		100
HPWT-DL00				70
HPWT-BL00				50
HPWN-MB00	InGaN Blue	2.0		110
HPWN-MC00	InGaN Cyan	5.0		110
HPWN-MG00	InGaN Green	4.5		110

Notes:

- Φ_V is the total luminous flux output as measured with an integrating sphere after the device has stabilized. ($R_{\theta J-A} = 200^\circ\text{C/W}$, $T_A = 25^\circ\text{C}$)
- $\theta_{0.90V}$ is the included angle at which 90% of the total luminous flux is captured.

Absolute Maximum Ratings at $T_A = 25^\circ\text{C}$

Table 2

Parameter	HPWA	HPWT	HPWN	Units
DC Forward Current ^[1]	70	70	50	mA
Power Dissipation	187	221	233	mW
Reverse Voltage ($I_R = 100 \mu\text{A}$)	10	10	0.55	V
Operating Temperature Range	-40 to +100			$^\circ\text{C}$
Storage Temperature Range	-55 to +100			$^\circ\text{C}$
High Temperature Chamber	125 $^\circ\text{C}$, 2 Hours			
LED Junction Temperature	125 $^\circ\text{C}$			
Solder Conditions ^[2]				
Preheat Temperature	85 +/- 15 $^\circ\text{C}$, 20 sec (Max 30 sec)			
Solder Temperature	235 +/- 5 $^\circ\text{C}$, 2.5 +/- 0.5 sec [1.5mm (0.06 in) below seating plane]			

Optical Characteristics at $T_A = 25^\circ\text{C}$, $I_F = 70\text{ mA}$ (HPWA, HPWT), $I_F = 50\text{ mA}$ (HPWN), $R_{\theta\text{J-A}} = 200^\circ\text{C/W}$

Table 3

Device Type	Peak Wavelength	Dominant Wavelength	Total Included Angle $\theta_{0.90\text{V}}$	Luminous Intensity/ Total Flux	Viewing Angle $2\theta^{1/2}$
	λ_{peak} (nm) Typ.	λ_{dom} (nm) ¹⁾ Typ.	(Degrees) ²⁾ Typ.	$I_v(\text{cd})/\Phi_v(\text{lm})$ Typ.	(Degrees) Typ.
HPWA-MH00	624	618	95	0.6	90
HPWA-DH00			75	0.9	60
HPWT-RD00			44 X 88	1.25	25 x 68
HPWT-MD00	640	630	100	0.6	70
HPWT-DD00			70	1.5	40
HPWT-BD00			50	2.0	30
HPWT-RH00			44 X 88	1.25	25 x 68
HPWT-MH00	626	620	100	0.6	70
HPWT-DH00			70	1.5	40
HPWT-BH00			50	2.0	30
HPWT-RL00			44 X 88	1.25	25 x 68
HPWT-ML00	596	594	100	0.6	70
HPWT-DL00			70	1.5	40
HPWT-BL00			50	2.0	30
HPWN-MB00	460	470	110	0.9	90
HPWN-MC00	503	505	110	0.9	90
HPWN-MG00	520	525	110	0.9	90

Notes:

- The dominant wavelength is derived from the CIE Chromaticity Diagram and represents the perceived color of the device.
- $\theta_{0.90\text{V}}$ is the included angle at which 90% of the total luminous flux is captured.

Electrical Characteristics at $T_A=25^\circ\text{C}$

Table 4

Device Type	Forward Voltage V_F (Volts) @ $I_F = 70\text{ mA}$ (HPWA, HPWT) $I_F = 50\text{ mA}$ (HPWN)			Reverse Breakdown V_R (Volts) ¹⁾ @ $I_R = 100$ μA		Capacitance C (pF) $V_F = 0$, F = 1MHz.	Thermal Resistance $R_{\theta\text{J-PIN}}$ ($^\circ\text{C/W}$)	Speed of Response τ_s (ns) ²⁾
	Min	Typ	Max	Min	Typ.	Typ.	Typ.	Typ.
HPWA-xH00	1.83	2.2	2.67	10	20	40	155	20
HPWT-xD00	2.19	2.6	3.03	10	20	40	125	20
HPWT-xH00	2.19	2.6	3.03	10	20	40	125	20
HPWT-xL00	2.19	2.6	3.15	10	20	40	125	20
HPWN-xB00	3.00	3.8	4.60	0.55	0.65	1900	130	20
HPWN-xC00	3.00	3.8	4.60	0.55	0.65	1900	130	20
HPWN-xG00	3.00	3.9	4.60	0.55	0.65	1900	130	20

Notes:

- Operation in reverse bias is not recommended.
- τ_s is the time constant, e^{-t/τ_s} .

Part Number Selection

Red

Part Number	Viewing Angle $2\theta^{1/2}$ (Degrees)	Min. Flux ⁽¹⁾ Φ_v (lm)	Max Flux Φ_v (lm)	Minimum Intensity (cd)	Maximum Intensity (cd)
HPWT-RD00-00000	25 X 68	1.5		1.9	
HPWT-RD00-D4000	25 X 68	2.0	4.8	2.5	6.0
HPWT-RD00-E4000	25 X 68	2.5	6.1	3.1	7.6
HPWT-RD00-F4000	25 X 68	3.0	7.3	3.8	9.1
HPWT-BD00-00000	30	1.5		3.0	
HPWT-BD00-D4000	30	2.0	4.8	4.0	9.6
HPWT-BD00-E4000	30	2.5	6.1	5.0	12.2
HPWT-BD00-F4000	30	3.0	7.3	6.0	14.6
HPWT-DD00-00000	40	1.5		2.3	
HPWT-DD00-D4000	40	2.0	4.8	3.0	7.2
HPWT-DD00-E4000	40	2.5	6.1	3.8	9.2
HPWT-DD00-F4000	40	3.0	7.3	4.5	11.0
HPWT-MD00-00000	70	1.5		0.9	
HPWT-MD00-D4000	70	2.0	4.8	1.2	2.9
HPWT-MD00-E4000	70	2.5	6.1	1.5	3.7
HPWT-MD00-F4000	70	3.0	7.3	1.8	4.4

Note:

1. Φ_v is the total luminous flux output as measured with an integrating sphere after the device has stabilized.

Red-Orange

Part Number	Viewing Angle $2\theta^{1/2}$ (Degrees)	Min. Flux Φ_v (lm)	Max Flux Φ_v (lm)	Minimum Intensity (cd)	Maximum Intensity (cd)
HPWT-RH00-00000	25 X 68	1.5		1.9	
HPWT-RH00-D4000	25 X 68	2.0	4.8	2.5	6.0
HPWT-RH00-E4000	25 X 68	2.5	6.1	3.1	7.6
HPWT-RH00-F4000	25 X 68	3.0	7.3	3.8	9.1
HPWT-RH00-G4000	25 X 68	3.5	9.7	4.4	12.1
HPWT-RH00-H4000	25 X 68	4.0	12.0	5.0	15.0
HPWT-BH00-00000	30	1.5		3.0	
HPWT-BH00-D4000	30	2.0	4.8	4.0	9.6
HPWT-BH00-E4000	30	2.5	6.1	5.0	12.2
HPWT-BH00-F4000	30	3.0	7.3	6.0	14.6
HPWT-BH00-G4000	30	3.5	9.7	7.0	19.4
HPWT-BH00-H4000	30	4.0	12.0	8.0	24.0
HPWT-DH00-00000	40	1.5		2.3	
HPWT-DH00-D4000	40	2.0	4.8	3.0	7.2
HPWT-DH00-E4000	40	2.5	6.1	3.8	9.2
HPWT-DH00-F4000	40	3.0	7.3	4.5	11.0
HPWT-DH00-G4000	40	3.5	9.7	5.3	14.6
HPWT-DH00-H4000	40	4.0	12.0	6.0	18.0
HPWT-MH00-00000	70	1.5		0.9	
HPWT-MH00-D4000	70	2.0	4.8	1.2	2.9
HPWT-MH00-E4000	70	2.5	6.1	1.5	3.7
HPWT-MH00-F4000	70	3.0	7.3	1.8	4.4
HPWT-MH00-G4000	70	3.5	9.7	2.1	5.8
HPWT-MH00-H4000	70	4.0	12.0	2.4	7.2
HPWA-MH00-B4000	90	1.0	3.6	0.6	2.2
HPWA-DH00-B4000	40	1.0	3.6	1.5	5.4
HPWA-MH00-C4000	90	1.5	4.2	0.9	2.5
HPWA-DH00-C4000	40	1.5	4.2	2.3	6.3

Amber

Part Number	Viewing Angle $2\theta^{1/2}$ (Degrees)	Min. Flux Φ_v (lm)	Max Flux Φ_v (lm)	Minimum Intensity (cd)	Maximum Intensity (cd)
HPWT-RL00-00000	25 X 68	1.0		1.3	
HPWT-RL00-C4000	25 X 68	1.5	4.2	1.9	5.3
HPWT-RL00-D4000	25 X 68	2.0	4.8	2.5	6.0
HPWT-BL00-00000	30	1.0		2.0	
HPWT-BL00-C4000	30	1.5	4.2	3.0	8.4
HPWT-BL00-D4000	30	2.0	4.8	4.0	9.6
HPWT-DL00-00000	40	1.0		1.5	
HPWT-DL00-C4000	40	1.5	4.2	2.3	6.3
HPWT-DL00-D4000	40	2.0	4.8	3.0	7.2
HPWT-ML00-00000	70	1.0		0.6	
HPWT-ML00-C4000	70	1.5	4.2	0.9	2.5
HPWT-ML00-D4000	70	2.0	4.8	1.2	2.9

Green

Part Number	Viewing Angle $2\theta^{1/2}$ (Degrees)	Min. Flux Φ_v (lm)	Max Flux Φ_v (lm)	Minimum Intensity (cd)	Maximum Intensity (cd)
HPWN-MG00-00000	90	3.0		2.7	

Cyan

Part Number	Viewing Angle $2\theta^{1/2}$ (Degrees)	Min. Flux Φ_v (lm)	Max Flux Φ_v (lm)	Minimum Intensity (cd)	Maximum Intensity (cd)
HPWN-MC00-00000	90	3.0		2.7	

Blue

Part Number	Viewing Angle $2\theta^{1/2}$ (Degrees)	Min. Flux Φ_v (lm)	Max Flux Φ_v (lm)	Minimum Intensity (cd)	Maximum Intensity (cd)
HPWN-MB00-00000	90	1.0		0.9	

Figures¹

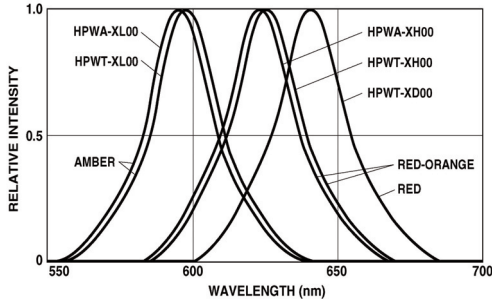

Figure 1a. Relative Intensity vs. Wavelength

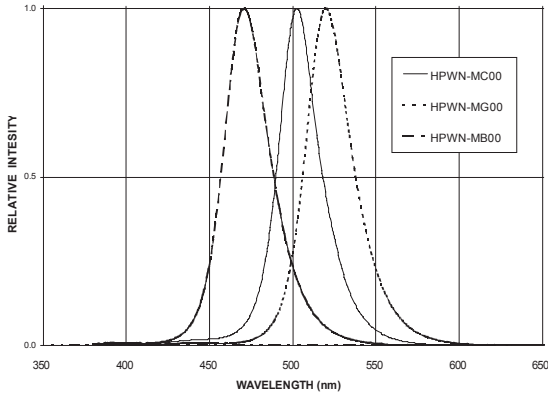

Figure 1b. Relative Intensity vs. Wavelength (HPWN)

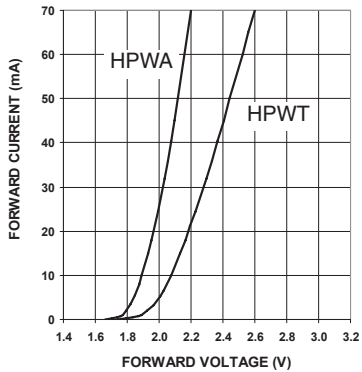

Figure 2a. Forward Current vs. Forward Voltage

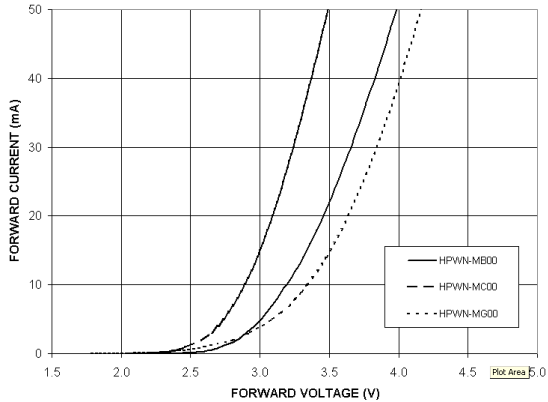

Figure 2b. Forward Current vs. Forward Voltage

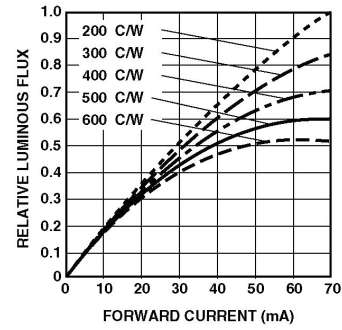

Figure 3. HPWA/HPWT-xx00 Relative Luminous Flux vs. Forward Current.

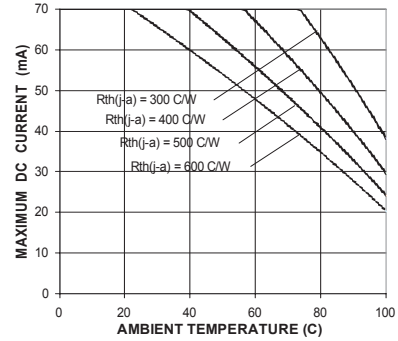

Figure 4a. HPWA-xx00 Maximum DC Forward Current vs. Ambient Temperature.

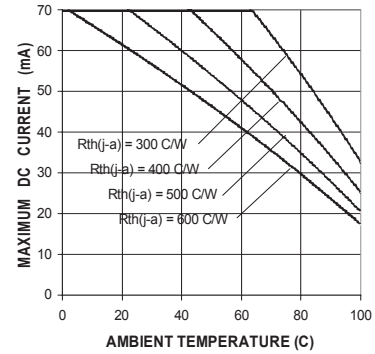

Figure 4b. HPWT-xx00 Maximum DC Forward Current vs. Ambient Temperature.

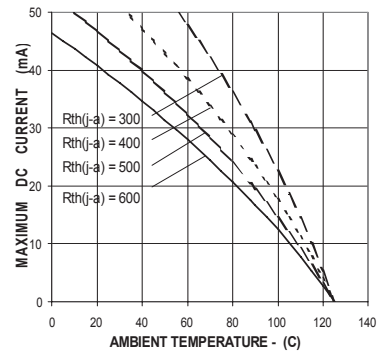

Figure 4c. HPWN-xx00 Maximum DC Forward Current vs. Ambient Temperature.

Note:

1.24mm² of Cu pad per emitter at cathode lead is recommended for lowest thermal resistance.

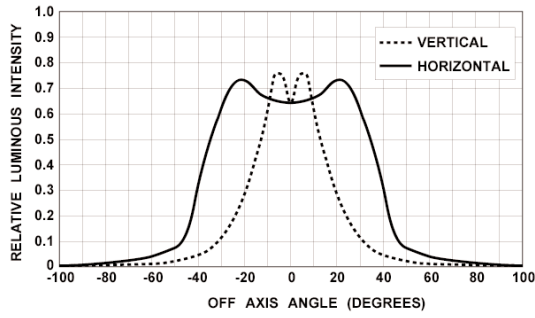

Figure 5a. HPWT-Rx00 Relative Luminous Intensity vs. Off Axis Angle.

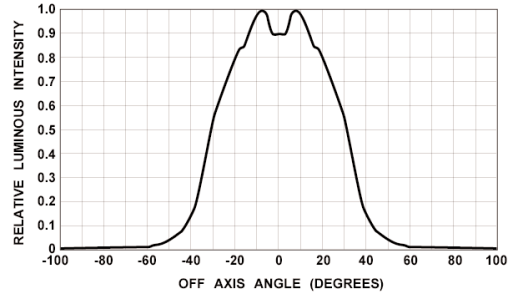

Figure 5d. HPWA(T)-Dx00 Relative Luminous Intensity vs. Off Axis Angle.

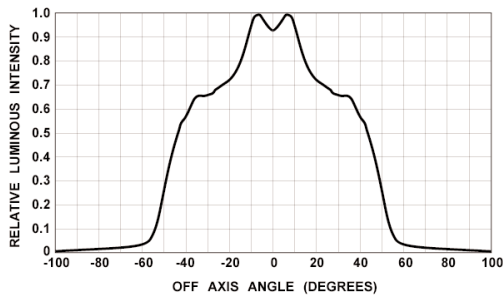

Figure 5b. HPWA-Mx00 Relative Luminous Intensity vs. Off Axis Angle.

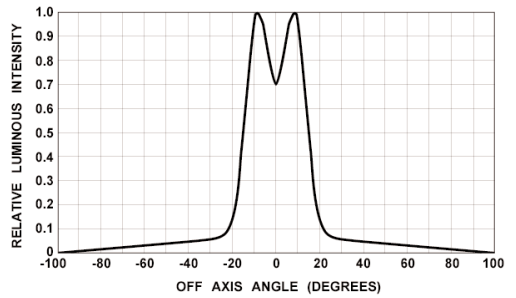

Figure 5e. HPWT-Bx00 Relative Luminous Intensity vs. Off Axis Angle.

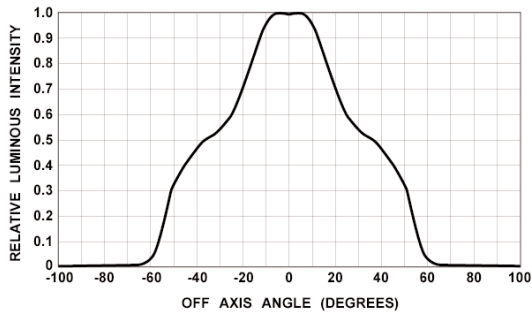

Figure 5c. HPWT-Mx00 Relative Luminous Intensity vs. Off Axis Angle.

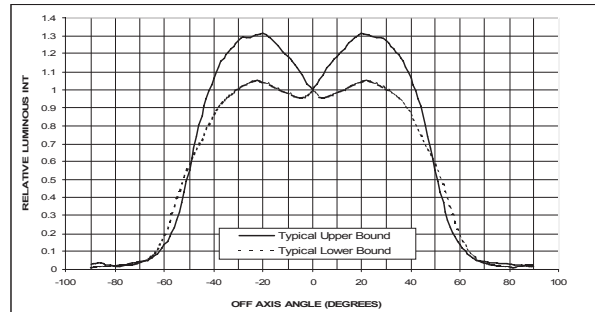

Figure 5f. HPWN-Mx00 Relative Luminous Intensity vs. Off Axis Angle

1. All Figures Typical unless indicated as Maximum.



Company Information

LUXEON®, SuperFlux and SnapLED are developed, manufactured and marketed by Philips Lumileds Lighting Company. Philips Lumileds is a world-class supplier of Light Emitting Diodes (LEDs) producing billions of LEDs annually. Philips Lumileds is a fully integrated supplier, producing core LED material in all three base colors (Red, Green, Blue) and White. Philips Lumileds has R&D centers in San Jose, California and in The Netherlands and production capabilities in San Jose and Penang, Malaysia. Founded in 1999, Philips Lumileds is the high-flux LED technology leader and is dedicated to bridging the gap between solid-state LED technology and the lighting world. Philips Lumileds technology, LEDs and systems are enabling new applications and markets in the lighting world.

Philips Lumileds may make process or materials changes affecting the performance or other characteristics of our products. These products supplied after such changes will continue to meet published specifications, but may not be identical to products supplied as samples or under prior orders.



WWW.LUXEON.COM
WWW.LUMILEDSFUTURE.COM

FOR TECHNICAL ASSISTANCE OR THE LOCATION OF YOUR NEAREST SALES OFFICE CONTACT ANY OF THE FOLLOWING:

NORTH AMERICA:
+1 888 589 3662 OR
ASKLUXEON@FUTUREELECTRONICS.COM

EUROPE:
OO 800 443 88 873 OR
LUXEON.EUROPE@FUTUREELECTRONICS.COM

ASIA:
800 5864 5337 OR
LUMILEDS.ASIA@FUTUREELECTRONICS.COM