

# Square-law compression amplifiers

## BA6138 / BA6138F

The BA6138 and BA6138F are square-law compression amplifiers designed for use as level meters in component stereos and tape decks. Two square root amplifiers with good linearity are included on the IC, as well as a muting pin for easy handling of power on/off.

●Applications

Level meters for tape decks, component stereos, and high-end radio cassette players

●Features

- 1) Consists of two square-law compression amplifiers with good linearity.
- 2) Good balance between channels with minimal crosstalk.
- 3) Includes a muting pin for easy handling of power on/off.
- 4) Good stability with respect to supply voltage fluctuations.
- 5) Operates on a single power supply.

●Block diagram

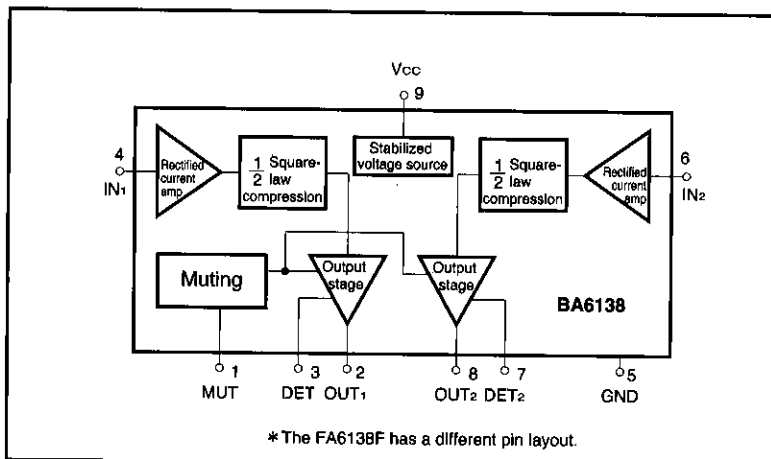

●Absolute maximum ratings (Ta = 25°C)

Parameter	Symbol	Limits	Unit
Supply voltage	Vcc	18	V
Power dissipation	BA6138	400 *1	mW
	BA6138F	300 *2	
Operating temperature	Topr	-20~75	°C
Storage temperature	Tstg	-50~125	°C

\*1 Above Ta = 25°C, decreases by 4 mW per degree.

\*2 Above Ta = 25°C, decreases by 3 mW per degree.

● Recommended operating conditions (Ta = 25°C)

Parameter	Symbol	Min.	Typ.	Max.	Unit
Supply voltage	V <sub>CC</sub>	8.5	—	16	V

● Electrical characteristics (unless otherwise noted, Ta = 25°C and V<sub>CC</sub> = 12V)

Parameter	Symbol	Min.	Typ.	Max.	Unit	Conditions	Measurement Circuit
Quiescent current	I <sub>Q</sub>	—	5	10	mA	I <sub>IN</sub> =0 μA	Fig.1
Quiescent output voltage	V <sub>OQ</sub>	—	30	100	mV	I <sub>IN</sub> =0 μA	Fig.1
Input resistance	R <sub>IN</sub>	1.5	2.1	3.2	kΩ	f=1kHz	Fig.1
Maximum input current	I <sub>IN Max.</sub>	—	—	2	mA	—	Fig.1
Maximum output voltage	V <sub>O Max.</sub>	4.0	4.6	—	V	—	Fig.1
Output voltage	V <sub>O</sub>	1.0	1.25	1.5	V	I <sub>IN</sub> =100 μA	Fig.1
Crosstalk	CT	—	60	—	dB	f=1kHz	Fig.1
Output voltage difference between channels	ΔV <sub>O</sub>	—	0	±120	mV	I <sub>IN</sub> =100 μA	Fig.1
Output voltage linearity	ΔV/ΔI	720	800	880	mV	I <sub>IN</sub> =10~100 μA	Fig.1

● Measurement circuit

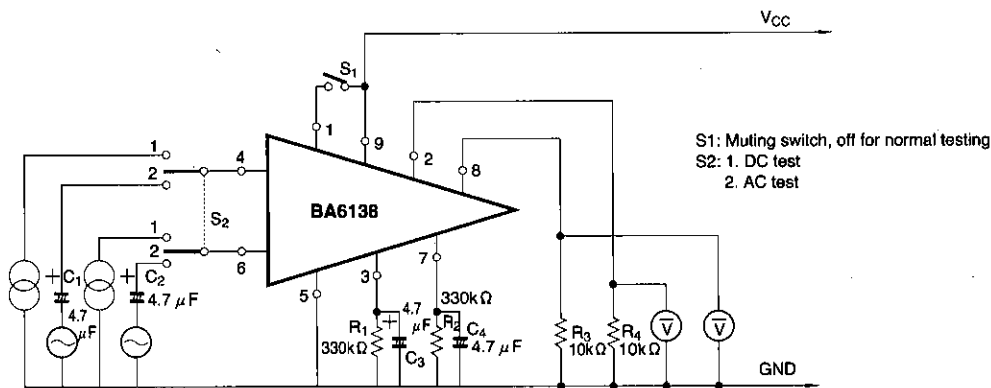

C<sub>3</sub>, R<sub>2</sub>, C<sub>4</sub>

These time constants determine the recovery time. With R<sub>1</sub> = R<sub>2</sub> = 330kΩ and C<sub>3</sub> = C<sub>4</sub> = 4.7 μF as in the application example, the recovery time is approximately 1 second. C<sub>3</sub> and C<sub>4</sub> can also be used as smoothing capacitors.

The attack time is related to the charging ability of the IC and the values of C<sub>3</sub> and C<sub>4</sub>. In the application example, it is approximately 1 ms.

Muting pin (Pin 1)

When Pin 1 is high, muting takes place.

The threshold voltage is approximately 1.5V (2V<sub>F</sub>).

If this pin is not used, open-circuit or ground it. A negative voltage of up to -10V can also be applied to this pin.

R<sub>3</sub>, R<sub>4</sub>

These form the load resistance of the BA6138. By making this resistance extremely low, the recovery time will shorten, however, dispersion will increase.

In the application example, the resistance can go to about 3.3kΩ. If the recovery time has been fixed, R<sub>1</sub> = R<sub>2</sub> can be decreased and C<sub>3</sub> = C<sub>4</sub> can be increased to lower the load resistance.

●Application example

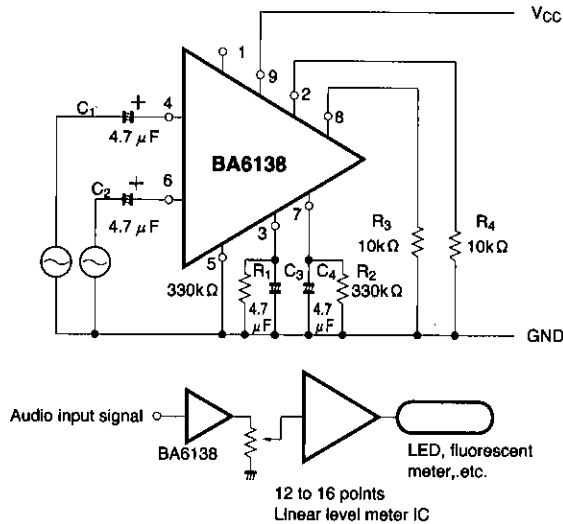

Fig. 2

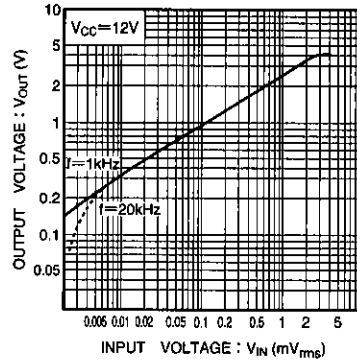

Fig. 3 Output voltage vs. input voltage

●Explanation of application circuit example

The application circuit shown in Fig. 2 is for the BA6138. The audio signal is compressed to its square root and generated to R<sub>3</sub> and R<sub>4</sub> as a DC output.

By introducing the output voltage of R<sub>3</sub> and R<sub>4</sub> into the input of a linear level meter IC (12 to 16 points, LED or fluorescent drive level meter IC), a high precision level meter can be created.

The relation between the input voltage and output voltage of the application example of Fig. 2 is shown in Fig. 3.

• Input resistance

In the application circuit, the output voltage becomes saturated if the input signal rises above 3V<sub>rms</sub>. By adding a resistor R<sub>IN</sub> in series with the input pin, the input-output voltage relation can be shifted.

To maintain good linearity, the value of the resistor should be no more than 3kΩ.

●For needle meters

The BA6138 / BA6138F can also be used for needle meters. The load resistance in this case is lower, thus the recovery time should be set with R<sub>1</sub> = R<sub>2</sub> small and C<sub>3</sub> = C<sub>4</sub> large.

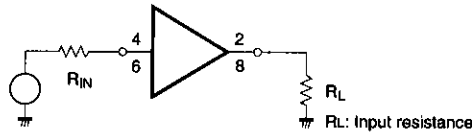

Fig. 4

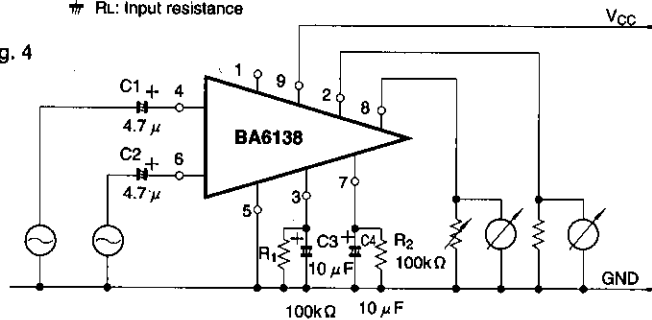
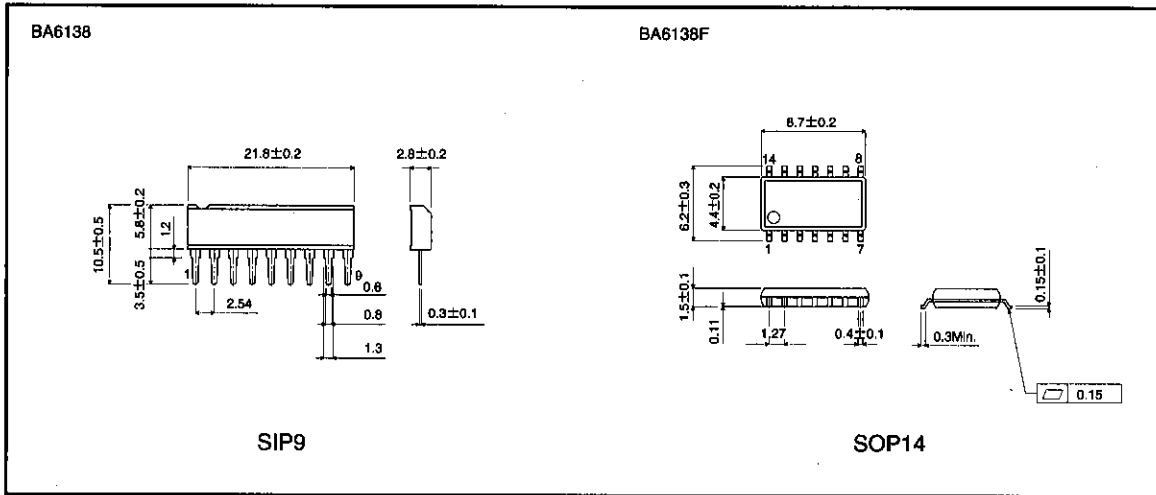

Fig. 5

●External dimensions (Unit: mm)



Square-law amplifiers

Audio accessory components