

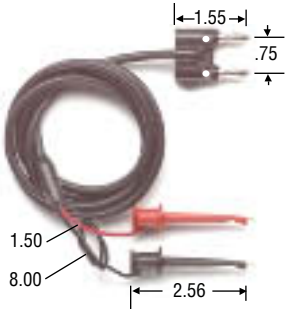

Pomona ACCESS

FAX ON DEMAND This symbol indicates immediate Fax-On-Demand Technical Information is available. Dial (U.S.) (800) 444-6785, (Outside U.S.) (909) 469-2991. Enter the Pomona Access number (shown in italics) when prompted.

MULTI-STACKING DOUBLE BANANA PLUG TO MINIGRABBER® TEST CLIPS



| <i>Pomona ACCESS</i> | Part No. | Length | PRICE |
|----------------------|-----------|--------|-------|
| 90584 | 3786-C-18 | 18" | 13.65 |
| | 3786-C-24 | 24" | 13.65 |
| | 3786-C-36 | 36" | 13.65 |
| | 3786-C-48 | 48" | 14.70 |
| | 3786-C-60 | 60" | 14.70 |

RATING: 300 VRMS, +50°C (+122°F) Max.
CABLE TYPE: RG58C/U, .195" O.D.

MULTI-STACKING DOUBLE BANANA PLUG TO MINIPINER® TEST CLIPS

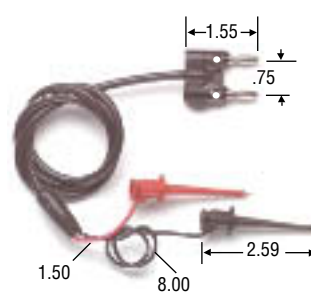

| <i>Pomona ACCESS</i> | Part No. | Length | PRICE |
|----------------------|-----------|--------|-------|
| 90825 | 5422-C-24 | 24" | 15.50 |
| | 5422-C-36 | 36" | 15.50 |
| | 5422-C-48 | 48" | 16.80 |
| | 5422-C-60 | 60" | 16.80 |

RATING: 300 VRMS, +50°C (+122°F) Max.
CABLE TYPE: RG58C/U, .195" O.D.

DOUBLE BANANA PLUG TO MICROGRABBER® TEST CLIPS

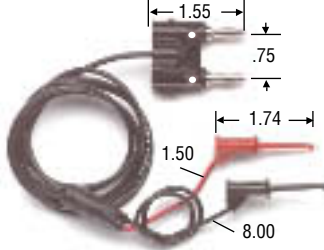

| <i>Pomona ACCESS</i> | Part No. | Length | PRICE |
|----------------------|-----------|--------|-------|
| 90824 | 4768-K-24 | 24" | 16.80 |
| | 4768-K-36 | 36" | 16.80 |
| | 4768-K-48 | 48" | 17.85 |
| | 4768-K-60 | 60" | 17.85 |

RATING: 150 VRMS, +50°C (+122°F) Max.
CABLE TYPE: RG174/U, .100" O.D.

TEST LEAD HOLDER

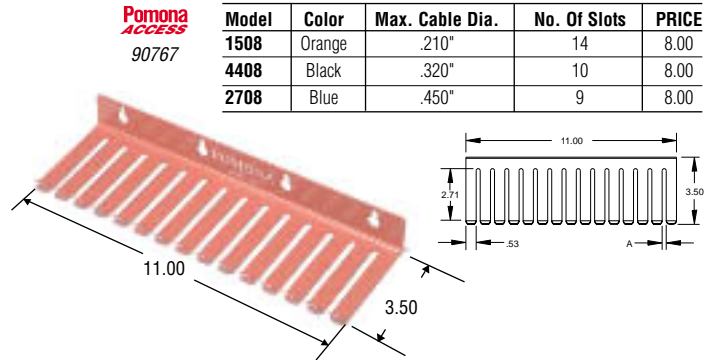

Pomona ACCESS
90767

| Model | Color | Max. Cable Dia. | No. Of Slots | PRICE |
|-------|--------|-----------------|--------------|-------|
| 1508 | Orange | .210" | 14 | 8.00 |
| 4408 | Black | .320" | 10 | 8.00 |
| 2708 | Blue | .450" | 9 | 8.00 |

DOUBLE BANANA PLUG TO ALLIGATOR TEST CLIPS

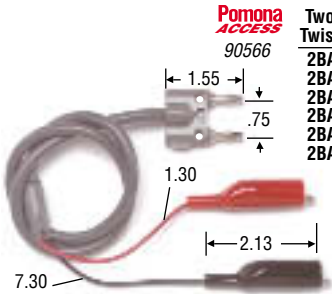

| <i>Pomona ACCESS</i> | Two Cond. Twisted Pair | PRICE | RG58C/U50Ω | Length | PRICE |
|----------------------|------------------------|-------|------------|--------|-------|
| 90566 | 2BA-AL-18 | 19.45 | 2BC-AL-18 | 18" | 16.30 |
| | 2BA-AL-24 | 19.45 | 2BC-AL-24 | 24" | 16.30 |
| | 2BA-AL-30 | 19.45 | 2BC-AL-30 | 30" | 16.30 |
| | 2BA-AL-36 | 19.45 | 2BC-AL-36 | 36" | 16.30 |
| | 2BA-AL-48 | 21.00 | 2BC-AL-48 | 48" | 17.60 |
| | 2BA-AL-60 | 21.00 | 2BC-AL-60 | 60" | 17.60 |

RATING: 150 VRMS, +50°C (+122°F) Max.
Jaws open to .300 Max.

MINIGATOR CLIPS TO MINIATURE DOUBLE BANANA PLUG

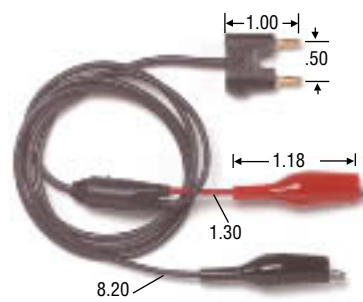

| <i>Pomona ACCESS</i> | Part No. | Length | PRICE |
|----------------------|-----------|--------|-------|
| 90823 | 3027-K-24 | 24" | 17.85 |

RATING: 45 VRMS, +50°C (+122°F) Max.
CABLE TYPE: RG174/U, .100" O.D.
Jaws open to .187" Max.

DOUBLE BANANA PLUG TO MINIGATOR TEST CLIPS

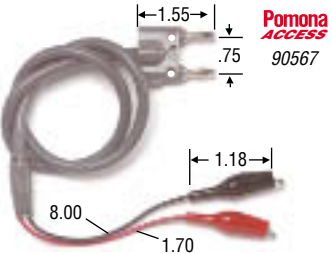

| <i>Pomona ACCESS</i> | Length | Two Cond. Twisted Pair | PRICE | RG58C/U | PRICE |
|----------------------|--------|------------------------|-------|-----------|-------|
| 90567 | 18" | 2BA-MG-18 | 21.80 | 2BC-MG-18 | 19.70 |
| | 24" | 2BA-MG-24 | 21.80 | 2BC-MG-24 | 19.70 |
| | 30" | 2BA-MG-30 | 21.80 | 2BC-MG-30 | 19.70 |
| | 36" | 2BA-MG-36 | 21.80 | 2BC-MG-36 | 19.70 |
| | 48" | 2BA-MG-48 | 23.10 | 2BC-MG-48 | 21.00 |
| | 60" | 2BA-MG-60 | 23.10 | 2BC-MG-60 | 21.00 |

RATING: 45 VRMS, +50°C (+122°F) Max.
Jaws open to .187" Max.

MULTI-STACKING DOUBLE BANANA PLUG TO MINIATURE DOUBLE BANANA PLUG



| <i>Pomona ACCESS</i> | Part No. | Length | PRICE |
|----------------------|-----------|--------|-------|
| 90822 | 2443-K-24 | 24" | 16.20 |
| | 2443-K-36 | 36" | 16.20 |
| | 2443-K-48 | 48" | 16.80 |
| | 2443-K-60 | 60" | 16.80 |

RATING: 1000 VRMS, +55°C (+131°F) Max.
CABLE TYPE: 50Ω, RG174/U, .100" O.D.

MINIATURE DOUBLE BANANA PLUG CABLE

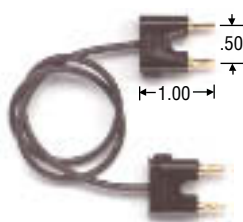

| <i>Pomona ACCESS</i> | Part No. | Length | PRICE |
|----------------------|-----------|--------|-------|
| 90555 | 2247-K-12 | 12" | 16.30 |
| | 2247-K-24 | 24" | 16.30 |
| | 2247-K-36 | 36" | 16.30 |
| | 2247-K-60 | 60" | 16.30 |

RATING: 1000 VRMS, +55°C (+131°F) Max.
CABLE TYPE: RG174/U, .100" O.D.

See chart on page 32 for additional cable specifications.