

HMC174MS8

GaAs MMIC T/R SWITCH DC - 3 GHz

Typical Applications

The HMC174MS8 is ideal for:

- ISM Applications
- PCMCIA Wireless Cards
- Portable Wireless

Functional Diagram

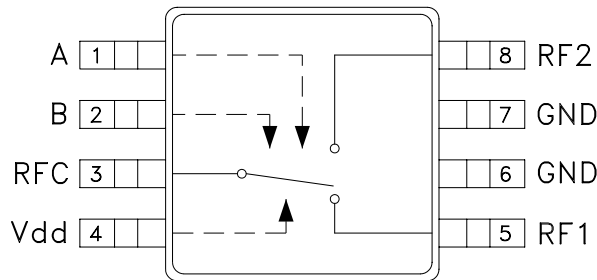

Features

- Ultra Small Package: MSOP8
- High Third Order Intercept: +60 dBm
- Single Positive Supply: +3 to +10V
- High RF power Capability

General Description

The HMC174MS8 is a low-cost SPDT switch in an 8-lead MSOP package for use in transmit-receive applications which require very low distortion at high signal power levels. The device can control signals from DC to 3.0 GHz and is especially suited for 900 MHz, 1.8 - 2.2 GHz, and 2.4 GHz ISM applications with only 0.5 dB loss. The design provides exceptional intermodulation performance; providing a +60 dBm third order intercept at 8 Volt bias. RF1 and RF2 are reflective shorts when "OFF". On-chip circuitry allows single positive supply operation at very low DC current with control inputs compatible with CMOS and most TTL logic families.

Electrical Specifications, $T_A = +25^\circ C$, $V_{dd} = +5 V_{dc}$, 50 Ohm System

| Parameter | Frequency | Min. | Typ. | Max. | Units |
|---------------------------------|--------------|----------------------------------|------|------|-------|
| Insertion Loss | DC - 1.0 GHz | | 0.5 | 0.7 | dB |
| | DC - 2.0 GHz | | 0.5 | 0.8 | dB |
| | DC - 2.5 GHz | | 0.7 | 1.0 | dB |
| | DC - 3.0 GHz | | 1.4 | 1.8 | dB |
| Isolation | DC - 1.0 GHz | 22 | 25 | | dB |
| | DC - 2.0 GHz | 20 | 24 | | dB |
| | DC - 2.5 GHz | 17 | 21 | | dB |
| | DC - 3.0 GHz | 13 | 17 | | dB |
| Return Loss | DC - 1.0 GHz | 20 | 28 | | dB |
| | DC - 2.0 GHz | 16 | 21 | | dB |
| | DC - 2.5 GHz | 13 | 17 | | dB |
| | DC - 3.0 GHz | 9 | 11 | | dB |
| Input Power for 1dB Compression | 0/8V Control | 0.5 - 1.0 GHz | 35 | 39 | dBm |
| | | 0.5 - 3.0 GHz | 34 | 38 | dBm |
| Input Third Order Intercept | 0/8V Control | 0.5 - 1.0 GHz | 55 | 60 | dBm |
| | | 0.5 - 3.0 GHz | 55 | 60 | dBm |
| Switching Characteristics | DC - 3.0 GHz | tRISE, tFALL (10/90% RF) | 10 | | ns |
| | | tON, tOFF (50% CTL to 10/90% RF) | 24 | | ns |

Insertion Loss

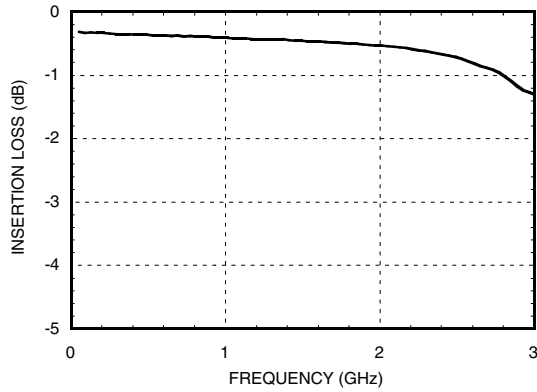

Isolation

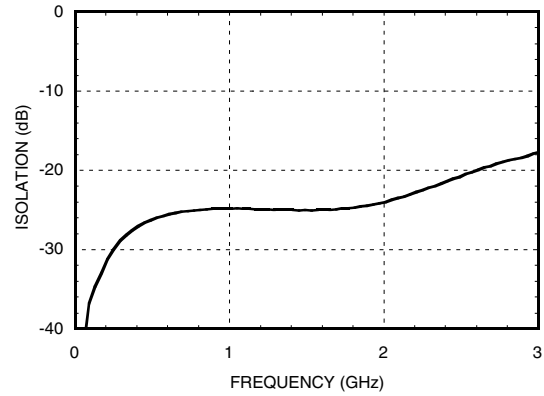

Return Loss

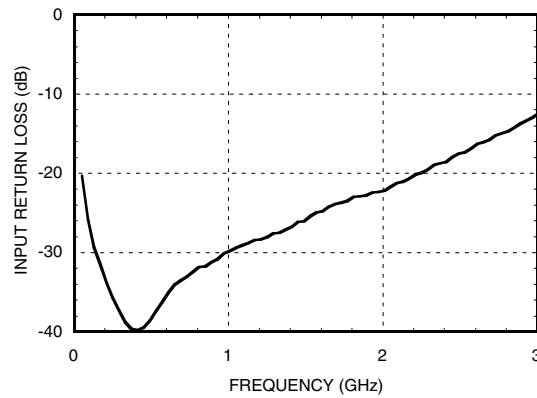

**Input 0.1 and 1.0 dB
Compression vs. Bias Voltage**

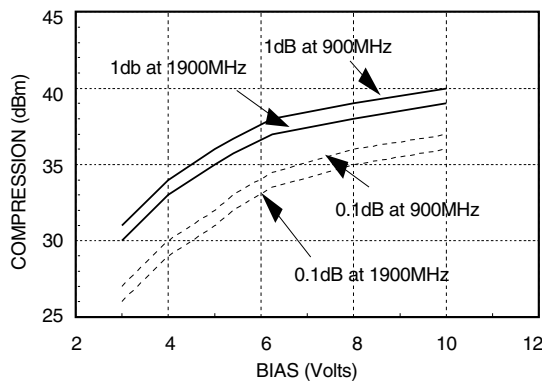

**Input Third Order
Intercept vs. Bias Voltage**

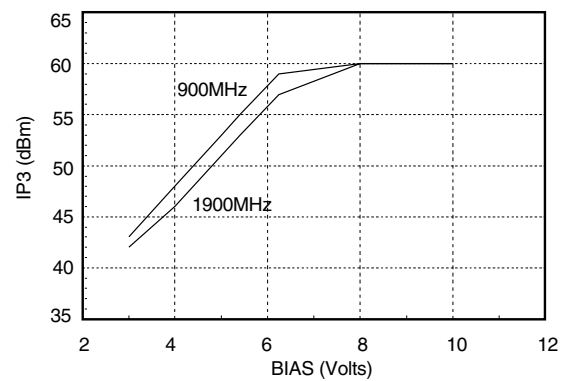

Compression vs. Bias Voltages

| Bias Vdd | Carrier at 900 MHz | | Carrier at 1900 MHz | |
|----------|------------------------------------|------------------------------------|------------------------------------|------------------------------------|
| | Input Power for 0.1 dB Compression | Input Power for 1.0 dB Compression | Input Power for 0.1 dB Compression | Input Power for 1.0 dB Compression |
| | (dBm) | (dBm) | (dBm) | (dBm) |
| 3 | 27 | 31 | 26 | 30 |
| 4 | 30 | 34 | 29 | 33 |
| 5 | 32 | 36 | 31 | 35 |
| 8 | 36 | 39 | 35 | 38 |
| 10 | 37 | 40 | 36 | 39 |

Distortion vs. Bias Voltage

| Bias Vdd | 1 Watt Carrier at 900 MHz | | | 1 Watt Carrier at 1900 MHz | | |
|----------|---------------------------|------------------------|-----------------|----------------------------|------------------------|-----------------|
| | Third Order Intercept | Second Order Intercept | Second Harmonic | Third Order Intercept | Second Order Intercept | Second Harmonic |
| | (dBm) | (dBm) | (dBc) | (dBm) | (dBm) | (dBc) |
| 3 | 43 | 71 | 45 | 42 | 78 | 55 |
| 4 | 48 | 85 | 55 | 46 | 88 | 65 |
| 5 | 53 | 90 | 56 | 51 | 87 | 58 |
| 8 | 60 | 90 | 58 | 60 | 90 | 59 |
| 10 | 60 | 90 | 59 | 60 | 90 | 60 |

Caution: Do not operate in 1dB compression at power levels above +35dBm and do not 'hot switch' power levels greater than +23dBm ($V_{dd} = +5Vdc$).

Truth Table

*Control Input Voltage Tolerances are $\pm 0.2 Vdc$

| Bias Vdd (Vdc) | Control Input* | | Bias Current Idd (uA) | Control Current Ia (uA) | Control Current Ib (uA) | Signal Path State | |
|----------------|----------------|---------|-----------------------|-------------------------|-------------------------|-------------------|-----------|
| | A (Vdc) | B (Vdc) | | | | RF to RF1 | RF to RF2 |
| 3 | 0 | 0 | 30 | -15 | -15 | OFF | OFF |
| 3 | 0 | Vdd | 25 | -25 | 0 | ON | OFF |
| 3 | Vdd | 0 | 25 | 0 | -25 | OFF | ON |
| 5 | 0 | 0 | 110 | -55 | -55 | OFF | OFF |
| 5 | 0 | Vdd | 115 | -100 | -15 | ON | OFF |
| 5 | Vdd | 0 | 115 | -15 | -100 | OFF | ON |
| 10 | 0 | 0 | 380 | -190 | -190 | OFF | OFF |
| 10 | 0 | Vdd | 495 | -275 | -220 | ON | OFF |
| 10 | Vdd | 0 | 495 | -220 | -275 | OFF | ON |
| 5 | -Vdd | Vdd | 600 | -600 | 225 | ON | OFF |
| 5 | Vdd | -Vdd | 600 | 225 | -600 | OFF | ON |

Absolute Maximum Ratings

| | |
|-------------------------------|------------------|
| Bias Voltage Range (Vdd) | -0.2 to +12 Vdc |
| Control Voltage Range (A & B) | -0.2 to +Vdd Vdc |
| Storage Temperature | -65 to +150 °C |
| Operating Temperature | -40 to +85 °C |

Outline Drawing

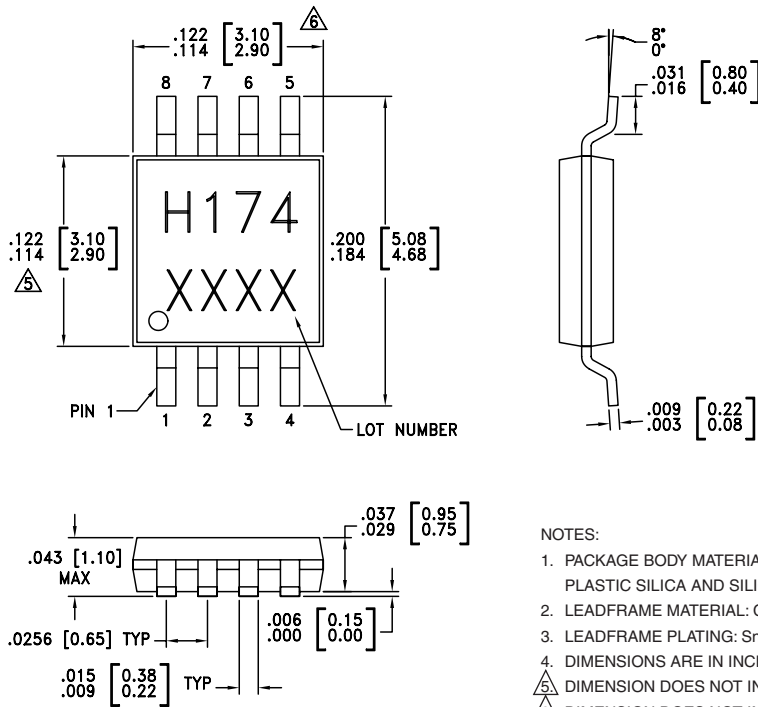

NOTES:

1. PACKAGE BODY MATERIAL: LOW STRESS INJECTION MOLDED PLASTIC SILICA AND SILICON IMPREGNATED.
2. LEADFRAME MATERIAL: COPPER ALLOY
3. LEADFRAME PLATING: Sn/Pb SOLDER
4. DIMENSIONS ARE IN INCHES [MILLIMETERS].
5. \triangle DIMENSION DOES NOT INCLUDE MOLDFLASH OF 0.15mm PER SIDE.
6. \triangle DIMENSION DOES NOT INCLUDE MOLDFLASH OF 0.25mm PER SIDE.
7. ALL GROUND LEADS MUST BE SOLDERED TO PCB RF GROUND.

Typical Application Circuit

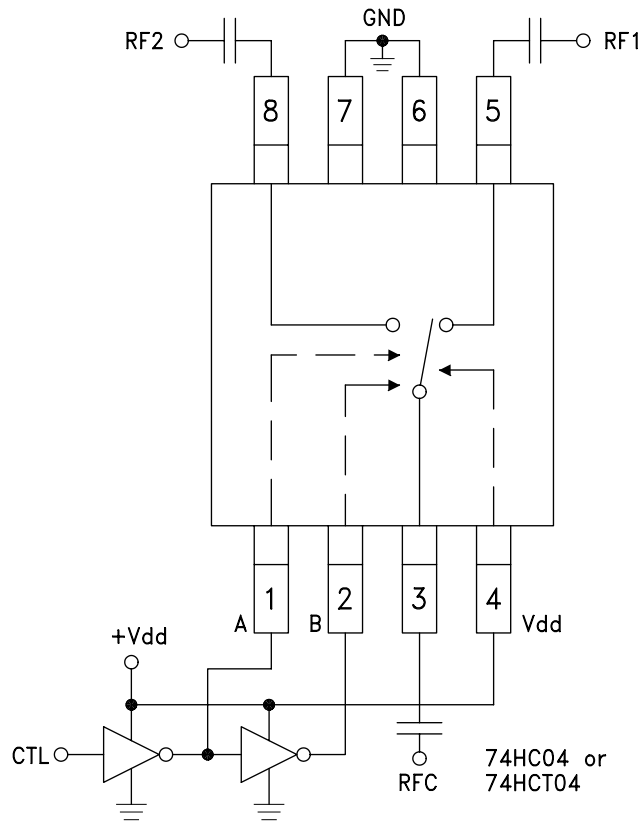

Notes:

1. Set logic gate and switch Vdd = +3V to +5V and use HCT series logic to provide a TTL driver interface.
2. Control inputs A/B can be driven directly with CMOS logic (HC) with Vdd of 3 to 8 Volts applied to the CMOS logic gates and to pin 4 of the RF switch.
3. DC Blocking capacitors are required for each RF port as shown. Capacitor value determines lowest frequency of operation.
4. Highest RF signal power capability is achieved with V set to +10V. The switch will operate properly (but at lower RF power capability) at bias voltages down to +3V.

Evaluation Circuit Board

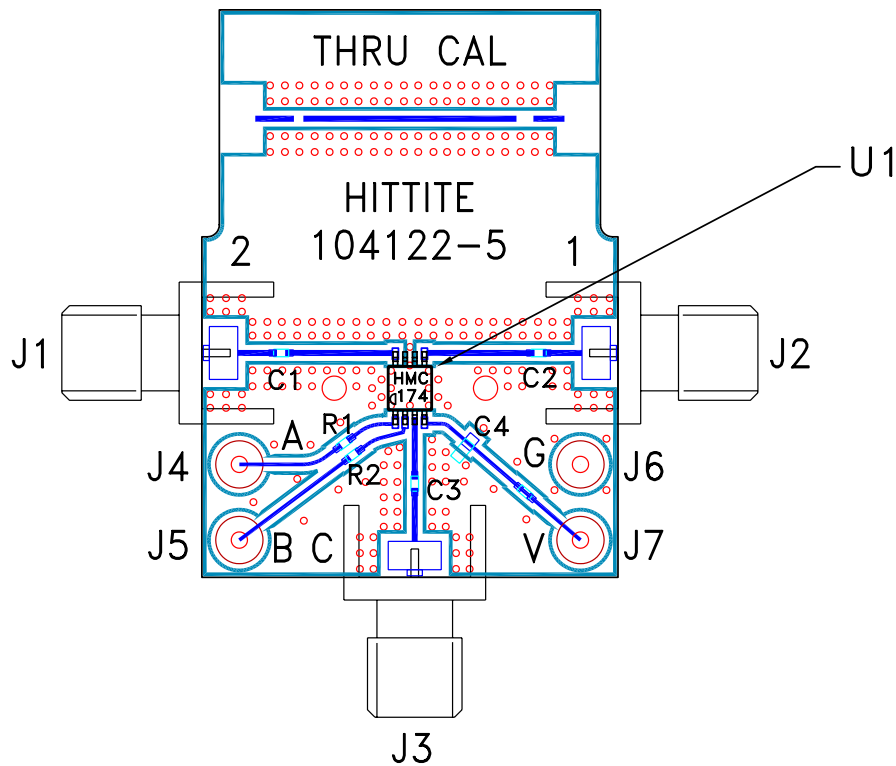

List of Material

| Item | Description |
|---------------------------------------|--------------------------------|
| J1 - J3 | PC Mount SMA RF Connector |
| J4 - J7 | DC Pin |
| C1 - C3 | 100 pF capacitor, 0402 Pkg. |
| C4 | 10,000 pF capacitor, 0603 Pkg. |
| U1 | HMC174MS8 T/R Switch |
| PCB* | 104122 Evaluation PCB |
| * Circuit Board Material: Rogers 4350 | |

The circuit board used in the final application should be generated with proper RF circuit design techniques. Signal lines at the RF port should have 50 ohm impedance and the package ground leads and package bottom should be connected directly to the ground plane similar to that shown above. The evaluation circuit board shown above is available from Hittite Microwave Corporation upon request.