

## Miniature LEDs (2.0mm Diameter)

|         | Line No. | Part No. | Lens        | Luminous Intensity at 20mA |         | Viewing Angle 2θ½ | Forward Voltage at 20mA |         | Peak Wave Length at 20mA | Drawing |
|---------|----------|----------|-------------|----------------------------|---------|-------------------|-------------------------|---------|--------------------------|---------|
|         |          |          |             | Minimum                    | Typical |                   | Typical                 | Maximum |                          |         |
| ● RED   | 1        | E3       | Translucent | 0.5mcd                     | 3.0mcd  | 45°               | 2.1V                    | 2.7V    | 700nm                    | A       |
| ● GREEN | 2        | E5       | Translucent | 0.5mcd                     | 3.0mcd  | 45°               | 2.1V                    | 2.7V    | 560nm                    | A       |

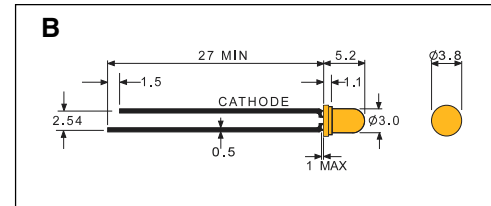

## T-1 LEDs (Very Bright)

|          | Line No. | Part No. | Lens        | Luminous Intensity at 20mA |         | Viewing Angle 2θ½ | Forward Voltage at 20mA |         | Peak Wave Length at 20mA | Drawing |
|----------|----------|----------|-------------|----------------------------|---------|-------------------|-------------------------|---------|--------------------------|---------|
|          |          |          |             | Minimum                    | Maximum |                   | Typical                 | Maximum |                          |         |
| ● RED    | 3        | E100     | Clear       | 90mcd                      | 200mcd  | 50°               | 2.1V                    | 3.0V    | 625nm                    | B       |
| ● ORANGE | 4        | E102     | Clear       | 90mcd                      | 200mcd  | 50°               | 2.1V                    | 3.0V    | 610nm                    | B       |
|          | 5        | E103     | Translucent | 56mcd                      | 160mcd  | 50°               | 2.1V                    | 3.0V    | 610nm                    | B       |
| ● YELLOW | 6        | E104     | Clear       | 90mcd                      | 200mcd  | 50°               | 2.2V                    | 3.0V    | 585nm                    | B       |
|          | 7        | E105     | Translucent | 56mcd                      | 160mcd  | 50°               | 2.2V                    | 3.0V    | 585nm                    | B       |
| ● GREEN  | 8        | E106     | Clear       | 90mcd                      | 200mcd  | 50°               | 2.2V                    | 3.0V    | 565nm                    | B       |
| ● RED    | 9        | E112     | Diffused    | 36mcd                      | 100mcd  | 60°               | 2.1V                    | 3.0V    | 625nm                    | B       |
| ● ORANGE | 10       | E113     | Diffused    | 36mcd                      | 100mcd  | 60°               | 2.1V                    | 3.0V    | 610nm                    | B       |
| ● YELLOW | 11       | E114     | Diffused    | 36mcd                      | 100mcd  | 60°               | 2.2V                    | 3.0V    | 585nm                    | B       |
| ● GREEN  | 12       | E116     | Diffused    | 36mcd                      | 100mcd  | 60°               | 2.2V                    | 3.0V    | 565nm                    | B       |

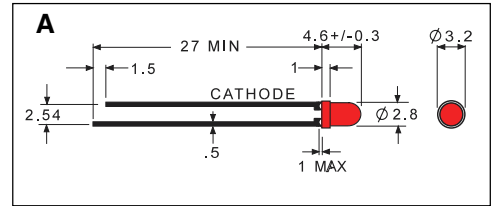

## T-1 LEDs with Resistor - 5V

| Line No. | Part No. | Lens    | Voltage Range |         | Luminous Intensity at 5VDC |         | Viewing Angle 2θ½ | Current Range at 5VDC |         | Peak Wave Length at 5VDC | Drawing |
|----------|----------|---------|---------------|---------|----------------------------|---------|-------------------|-----------------------|---------|--------------------------|---------|
|          |          |         | Minimum       | Maximum | Minimum                    | Maximum |                   | Minimum               | Maximum |                          |         |
| ● RED    | 1        | E404-5V | 4.0VDC        | 6.0VDC  | 70mcd                      | 200mcd  | 60°               | 8mA                   | 15.5mA  | 660nm                    | A       |
| ● YELLOW | 2        | E449-5V | 4.0VDC        | 6.0VDC  | 8mcd                       | 15mcd   | 60°               | 8mA                   | 15.5mA  | 590nm                    | A       |
| ● GREEN  | 3        | E451-5V | 4.0VDC        | 6.0VDC  | 12mcd                      | 20mcd   | 60°               | 8mA                   | 15.5mA  | 565nm                    | A       |

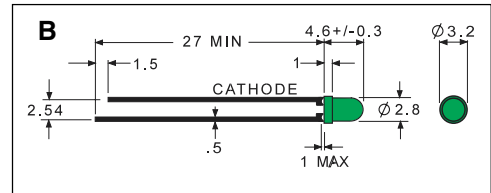

## T-1 Low Current LEDs (2mA)

| Line No. | Part No. | Lens | Luminous Intensity at 2mA |         | Viewing Angle 2θ½ | Forward Voltage at 20mA |         | Peak Wave Length at 20mA | Drawing |
|----------|----------|------|---------------------------|---------|-------------------|-------------------------|---------|--------------------------|---------|
|          |          |      | Minimum                   | Typical |                   | Typical                 | Maximum |                          |         |
| ● RED    | 4        | E28  | 8.0mcd                    | 20.0mcd | 60°               | 1.85V                   | 2.50V   | 660nm                    | B       |
| ● RED    | 5        | E30  | 0.8mcd                    | 2.00mcd | 60°               | 2.00V                   | 2.50V   | 625nm                    | B       |
| ● YELLOW | 6        | E31  | 0.8mcd                    | 2.00mcd | 60°               | 2.10V                   | 2.50V   | 590nm                    | B       |
| ● GREEN  | 7        | E32  | 0.8mcd                    | 2.00mcd | 60°               | 2.20V                   | 2.50V   | 565nm                    | B       |

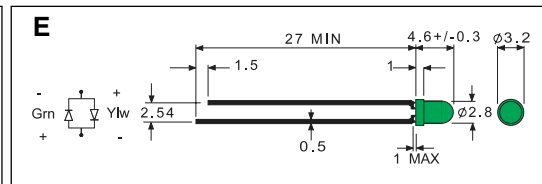
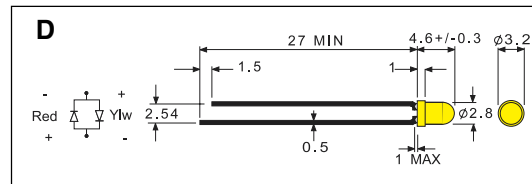
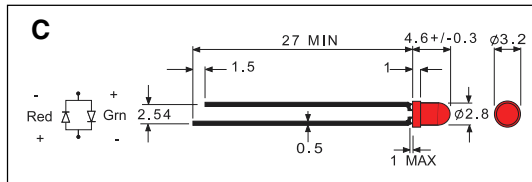

## T-1 Bi-Color LEDs (Two Leads)

| Line No.              | Part No. | Lens           | Luminous Intensity at 20mA |         | Viewing Angle 2θ½ | Forward Voltage at 20mA |         | Peak Wave Length at 20mA | Drawing |
|-----------------------|----------|----------------|----------------------------|---------|-------------------|-------------------------|---------|--------------------------|---------|
|                       |          |                | Minimum                    | Maximum |                   | Typical                 | Maximum |                          |         |
| ● RED &<br>● GREEN    | 8        | White Diffused | 8mcd                       | 40mcd   | 60°               | 2.0V                    | 2.5V    | 625nm                    | C       |
| ● RED &<br>● YELLOW   | 9        | White Diffused | 8mcd                       | 40mcd   | 60°               | 2.0V                    | 2.5V    | 625nm                    | D       |
| ● GREEN &<br>● YELLOW | 10       | White Diffused | 8mcd                       | 40mcd   | 60°               | 2.2V                    | 2.5V    | 565nm                    | E       |

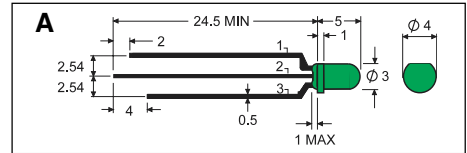

## T-1 Bi-Color LEDs (Three Leads)

|                    | Line No. | Part No. | Lens           | Luminous Intensity at 20mA |         | Viewing Angle 2θ½ | Forward Voltage at 20mA |         | Peak Wave Length at 20mA | Leads  | Drawing |
|--------------------|----------|----------|----------------|----------------------------|---------|-------------------|-------------------------|---------|--------------------------|--|---------|
|                    |          |          |                | Minimum                    | Maximum |                   | Typical                 | Maximum |                          |  |         |
| ● RED & ● GREEN    | 1        | E219     | White Diffused | 12.5mcd                    | 50mcd   | 60°               | 2.0V                    | 2.5V    | 625nm<br>565nm           | 1.Red Anode<br>2.Cathode<br>3.Green Anode    | A       |
| ● GREEN & ● YELLOW | 2        | E220     | White Diffused | 12.5mcd                    | 50mcd   | 60°               | 2.2V                    | 2.5V    | 565nm<br>590nm           | 1.Green Anode<br>2.Cathode<br>3.Yellow Anode | A       |
| ● RED & ● GREEN    | 3        | E293     | White Diffused | 90mcd                      | 300mcd  | 60°               | 1.85V                   | 2.5V    | 660nm<br>565nm           | 1.Red Cathode<br>2.Anode<br>3.Green Cathode  | A       |

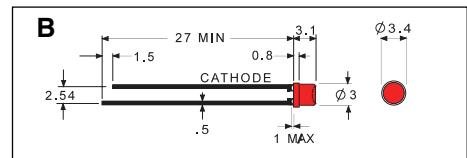

## Mini LEDs

|                       | Line No. | Part No. | Lens        | Luminous Intensity at 10mA |         | Viewing Angle 2θ½ | Forward Voltage at 20mA |         | Peak Wave Length at 20mA | Drawing |
|-----------------------|----------|----------|-------------|----------------------------|---------|-------------------|-------------------------|---------|--------------------------|---------|
|                       |          |          |             | Minimum                    | Maximum |                   | Typical                 | Maximum |                          |         |
| ● ULTRA BRIGHT RED    | 4        | E260     | Translucent | 20.0mcd                    | 60.0mcd | 130°              | 1.85V                   | 2.5V    | 660nm                    | B       |
| ● HIGH EFFICIENCY RED | 5        | E261     | Translucent | 4.0mcd                     | 7.0mcd  | 130°              | 2.0V                    | 2.5V    | 625nm                    | B       |
| ● ORANGE              | 6        | E262     | Translucent | 3.0mcd                     | 7.0mcd  | 130°              | 2.0V                    | 2.6V    | 610nm                    | B       |
| ● YELLOW              | 7        | E263     | Translucent | 2.0mcd                     | 3.5mcd  | 130°              | 2.1V                    | 2.5V    | 590nm                    | B       |
| ● SUPER BRIGHT GREEN  | 8        | E264     | Translucent | 10.0mcd                    | 16.0mcd | 130°              | 2.2V                    | 2.5V    | 565nm                    | B       |

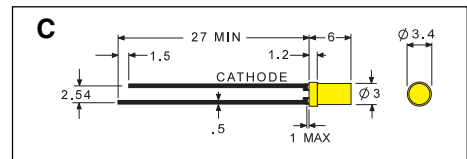

## T-1 Flat Top LEDs

|          | Line No. | Part No. | Lens     | Luminous Intensity at 10mA |         | Viewing Angle 2θ½ | Forward Voltage at 20mA |         | Peak Wave Length at 20mA | Drawing |
|----------|----------|----------|----------|----------------------------|---------|-------------------|-------------------------|---------|--------------------------|---------|
|          |          |          |          | Minimum                    | Maximum |                   | Typical                 | Maximum |                          |         |
| ● RED    | 9        | E265     | Diffused | 40.0mcd                    | 80.0mcd | 100°              | 1.85V                   | 2.5V    | 660nm                    | C       |
| ● RED    | 10       | E266     | Diffused | 3.2mcd                     | 12.5mcd | 100°              | 2.0V                    | 2.5V    | 625nm                    | C       |
| ● ORANGE | 11       | E267     | Diffused | 3.2mcd                     | 12.5mcd | 100°              | 2.0V                    | 2.6V    | 610nm                    | C       |
| ● YELLOW | 12       | E268     | Diffused | 1.3mcd                     | 8.0mcd  | 100°              | 2.1V                    | 2.5V    | 590nm                    | C       |
| ● GREEN  | 13       | E269     | Diffused | 8.0mcd                     | 20.0mcd | 100°              | 2.2V                    | 2.5V    | 565nm                    | C       |

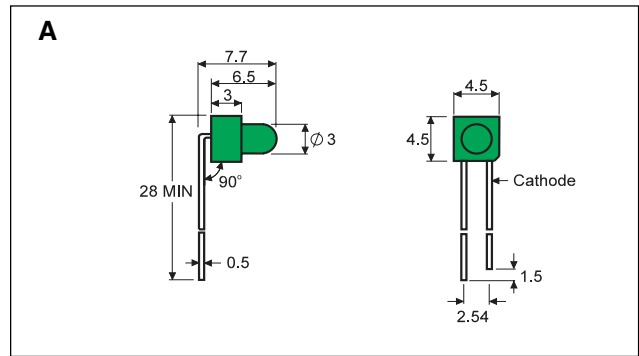

## T-1, Right Angle LEDs (3mm)

|          | Line No. | Part No. | Lens     | Luminous Intensity at 10mA |         | Viewing Angle 2θ½ | Forward Voltage at 20mA |         | Peak Wave Length at 20mA | Drawing |
|----------|----------|----------|----------|----------------------------|---------|-------------------|-------------------------|---------|--------------------------|---------|
|          |          |          |          | Typical                    | Maximum |                   | Typical                 | Maximum |                          |         |
| ● RED    | 1        | E341     | Diffused | 12.5mcd                    | 32.0mcd | 60°               | 2.0V                    | 2.5V    | 625nm                    | A       |
| ● YELLOW | 2        | E344     | Diffused | 5.0mcd                     | 20.0mcd | 60°               | 2.1V                    | 2.5V    | 590nm                    | A       |
| ● GREEN  | 3        | E346     | Diffused | 5.0mcd                     | 20.0mcd | 60°               | 2.2V                    | 2.5V    | 565nm                    | A       |

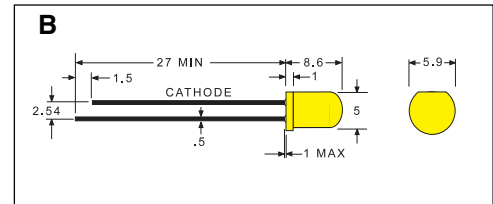

## T-1¾ LEDs (Very Bright)

|          | Line No. | Part No. | Lens     | Luminous Intensity at 20mA |         | Viewing Angle 2θ½ | Forward Voltage at 20mA |         | Peak Wave Length at 20mA | Drawing |
|----------|----------|----------|----------|----------------------------|---------|-------------------|-------------------------|---------|--------------------------|---------|
|          |          |          |          | Minimum                    | Maximum |                   | Typical                 | Maximum |                          |         |
| ● RED    | 4        | E118     | Diffused | 36mcd                      | 100mcd  | 60°               | 2.1V                    | 3.0V    | 625nm                    | B       |
| ● ORANGE | 5        | E119     | Diffused | 36mcd                      | 100mcd  | 60°               | 2.1V                    | 3.0V    | 610nm                    | B       |
| ● YELLOW | 6        | E120     | Diffused | 36mcd                      | 100mcd  | 60°               | 2.2V                    | 3.0V    | 585nm                    | B       |
| ● GREEN  | 7        | E121     | Diffused | 36mcd                      | 100mcd  | 60°               | 2.2V                    | 3.0V    | 565nm                    | B       |

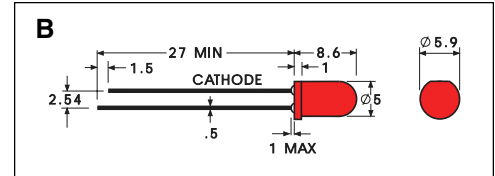
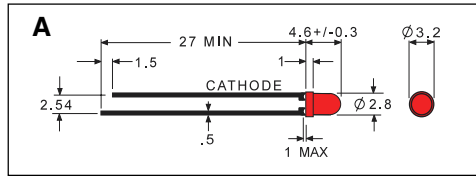

## T-1 and T-1<sup>3/4</sup> ,Ultra Bright, Red GaAlAs LEDs

| Line No. | Part No. | Size | Lens               | Luminous Intensity at 20mA |         | Viewing Angle 2θ <sup>1/2</sup> | Forward Voltage at 20mA |         | Peak Wave Length at 20mA | Drawing |   |
|----------|----------|------|--------------------|----------------------------|---------|---------------------------------|-------------------------|---------|--------------------------|---------|---|
|          |          |      |                    | Minimum                    | Maximum |                                 | Typical                 | Maximum |                          |         |   |
| ● RED    | 1        | E169 | T-1                | Clear                      | 360mcd  | 500mcd                          | 50°                     | 1.85V   | 2.50V                    | 660nm   | A |
| ● RED    | 2        | E170 | T-1                | Clear                      | 500mcd  | 700mcd                          | 50°                     | 1.85V   | 2.50V                    | 660nm   | A |
| ● RED    | 3        | E171 | T-1                | Clear                      | 700mcd  | 1000mcd                         | 50°                     | 1.85V   | 2.50V                    | 660nm   | A |
| ● RED    | 4        | E197 | T-1                | Clear                      | 1200mcd | 1400mcd                         | 50°                     | 1.85V   | 2.50V                    | 660nm   | A |
| ● RED    | 5        | E181 | T-1 <sup>3/4</sup> | Clear                      | 500mcd  | 1000mcd                         | 30°                     | 1.85V   | 2.5V                     | 660nm   | B |
| ● RED    | 6        | E183 | T-1 <sup>3/4</sup> | Clear                      | 1300mcd | 1600mcd                         | 30°                     | 1.85V   | 2.5V                     | 660nm   | B |
| ● RED    | 7        | E184 | T-1 <sup>3/4</sup> | Clear                      | 2000mcd | 3500mcd                         | 30°                     | 1.85V   | 2.5V                     | 660nm   | B |
| ● RED    | 8        | E301 | T-1 <sup>3/4</sup> | Diffused                   | 110mcd  | 200mcd                          | 60°                     | 1.85V   | 2.5V                     | 660nm   | B |
| ● RED    | 9        | E303 | T-1 <sup>3/4</sup> | Diffused                   | 200mcd  | 300mcd                          | 60°                     | 1.85V   | 2.5V                     | 660nm   | B |
| ● RED    | 10       | E304 | T-1 <sup>3/4</sup> | Diffused                   | 300mcd  | 500mcd                          | 60°                     | 1.85V   | 2.5V                     | 660nm   | B |

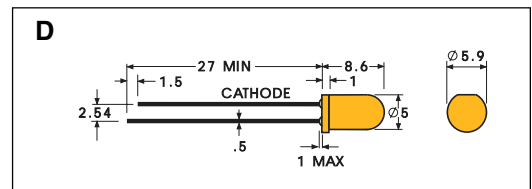
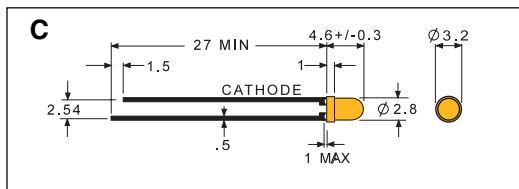

## T-1 and T-1<sup>3/4</sup>, Ultra Bright, Orange InGaAlP LEDs

| Line No. | Part No. | Size | Lens               | Luminous Intensity at 20mA |         | Viewing Angle 2θ <sup>1/2</sup> | Forward Voltage at 20mA |         | Peak Wave Length at 20mA | Drawing |   |
|----------|----------|------|--------------------|----------------------------|---------|---------------------------------|-------------------------|---------|--------------------------|---------|---|
|          |          |      |                    | Minimum                    | Maximum |                                 | Typical                 | Maximum |                          |         |   |
| ● ORANGE | 11       | E199 | T-1                | Orange Translucent         | 500mcd  | 1600mcd                         | 50°                     | 1.8V    | 2.3V                     | 620nm   | C |
| ● ORANGE | 12       | E194 | T-1 <sup>3/4</sup> | Orange Translucent         | 700mcd  | 3000mcd                         | 30°                     | 1.8V    | 2.3V                     | 620nm   | D |

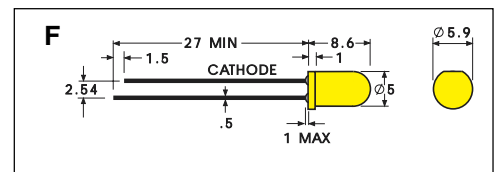
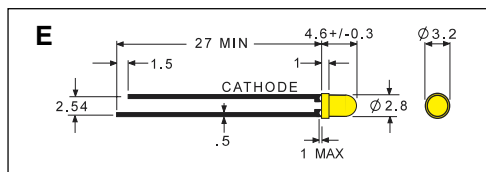

## T-1 and T-1<sup>3/4</sup>, Ultra Bright , Yellow InGaAlP LEDs

| Line No. | Part No. | Size | Lens               | Luminous Intensity at 20mA |         | Viewing Angle 2θ <sup>1/2</sup> | Forward Voltage at 20mA |         | Peak Wave Length at 20mA | Drawing |   |
|----------|----------|------|--------------------|----------------------------|---------|---------------------------------|-------------------------|---------|--------------------------|---------|---|
|          |          |      |                    | Minimum                    | Maximum |                                 | Typical                 | Maximum |                          |         |   |
| ● YELLOW | 13       | E198 | T-1                | Yellow Translucent         | 300mcd  | 1000mcd                         | 50°                     | 2.0V    | 2.5V                     | 595nm   | E |
| ● YELLOW | 14       | E195 | T-1 <sup>3/4</sup> | Yellow Translucent         | 400mcd  | 1600mcd                         | 30°                     | 2.0V    | 2.5V                     | 595nm   | F |

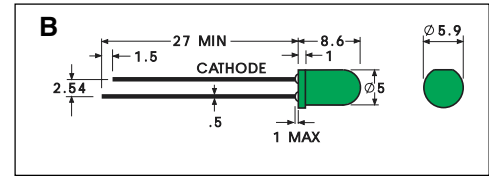
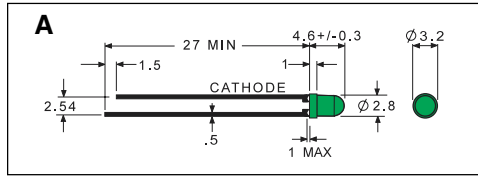

## T-1 and T-1<sup>3/4</sup>, Super Bright, Green GaP LEDs

|         | Line No. | Part No. | Size               | Lens     | Luminous Intensity at 20mA |         | Viewing Angle 2θ <sub>1/2</sub> | Forward Voltage at 20mA |         | Peak Wave Length at 20mA | Drawing |
|---------|----------|----------|--------------------|----------|----------------------------|---------|---------------------------------|-------------------------|---------|--------------------------|---------|
|         |          |          |                    |          | Minimum                    | Maximum |                                 | Typical                 | Maximum |                          |         |
| ● GREEN | 1        | E166     | T-1                | Clear    | 100mcd                     | 300mcd  | 50°                             | 2.2V                    | 2.5V    | 565nm                    | A       |
| ● GREEN | 2        | E196     | T-1                | Diffused | 40mcd                      | 60mcd   | 60°                             | 2.2V                    | 2.5V    | 565nm                    | A       |
| ● GREEN | 3        | E168     | T-1 <sup>3/4</sup> | Clear    | 100mcd                     | 200mcd  | 30°                             | 2.2V                    | 2.5V    | 565nm                    | B       |

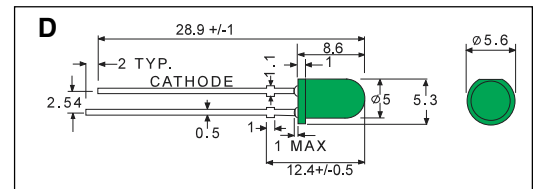
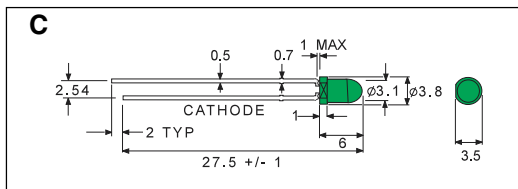

## T-1 and T-1<sup>3/4</sup>, Mega Bright Green, GaN LEDs

|         | Line No. | Part No. | Size               | Lens  | Luminous Intensity at 20mA |           | Viewing Angle 2θ <sub>1/2</sub> | Forward Voltage at 20mA |         | Reverse Current (V <sub>R</sub> =5.0V) | Peak Wave Length at 20mA | Drawing |
|---------|----------|----------|--------------------|-------|----------------------------|-----------|---------------------------------|-------------------------|---------|--|--------------------------|---------|
|         |          |          |                    |       | Minimum                    | Typical   |                                 | Typical                 | Maximum |  |                          |         |
| ● GREEN | 4        | E902     | T-1                | Clear | 2000mcd                    | 6800mcd   | 15°                             | 3.5V                    | 4.0V    | 50μA                                   | 525nm                    | C       |
| ● GREEN | 5        | E903     | T-1 <sup>3/4</sup> | Clear | 2500mcd                    | 10,000mcd | 15°                             | 3.5V                    | 4.0V    | 50μA                                   | 525nm                    | D       |

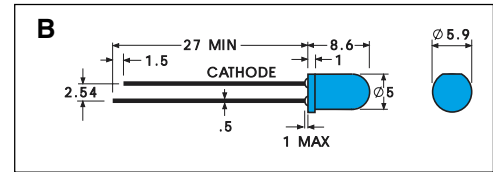
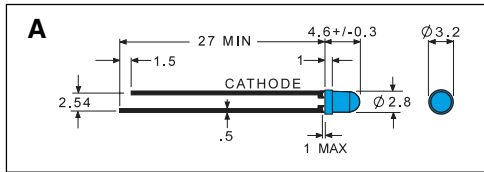

## T-1 and T-1<sup>3/4</sup>, Super Bright, Blue GaN LEDs

| Line No. | Part No. | Size | Lens               | Luminous Intensity at 20mA |         | Viewing Angle 2θ <sup>1/2</sup> | Forward Voltage at 20mA |         | Peak Wave Length at 20mA | Drawing |   |
|----------|----------|------|--------------------|----------------------------|---------|---------------------------------|-------------------------|---------|--------------------------|---------|---|
|          |          |      |                    | Minimum                    | Maximum |                                 | Typical                 | Maximum |                          |         |   |
| ● BLUE   | 1        | E472 | T-1                | Clear                      | 20.0mcd | 90.0mcd                         | 20°                     | 4.5V    | 5.5V                     | 430nm   | A |
| ● BLUE   | 2        | E474 | T-1 <sup>3/4</sup> | Clear                      | 60.0mcd | 150.0mcd                        | 16°                     | 4.5V    | 5.5V                     | 430nm   | B |

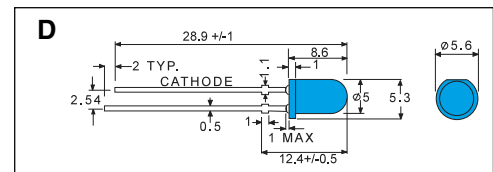
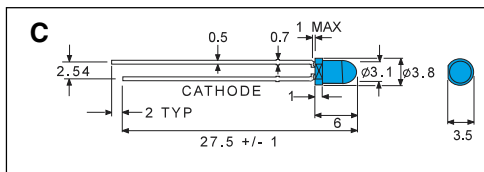

## T-1 and T-1<sup>3/4</sup>, Mega Bright Blue GaN LEDs

| Line No. | Part No. | Size | Lens               | Luminous Intensity at 20mA |         | Viewing Angle 2θ <sup>1/2</sup> | Forward Voltage at 20mA |         | Reverse Current (V <sub>R</sub> =5.0V) | Peak Wave Length at 20mA | Drawing |   |
|----------|----------|------|--------------------|----------------------------|---------|---------------------------------|-------------------------|---------|--|--------------------------|---------|---|
|          |          |      |                    | Minimum                    | Typical |                                 | Typical                 | Maximum |  |                          |         |   |
| ● BLUE   | 3        | E482 | T-1                | Clear                      | 500mcd  | 2000mcd                         | 15°                     | 3.6V    | 4.0V                                   | 50μA                     | 470nm   | C |
| ● BLUE   | 4        | E484 | T-1 <sup>3/4</sup> | Clear                      | 750mcd  | 3000mcd                         | 15°                     | 3.6V    | 4.0V                                   | 50μA                     | 470nm   | D |



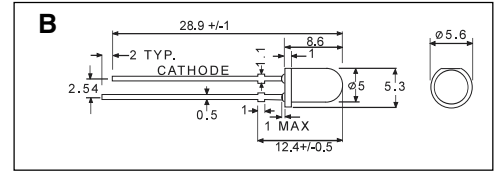
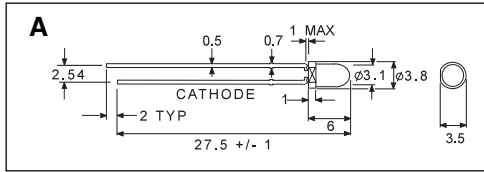

## T-1 and T-1<sup>3/4</sup>, Mega Bright White LEDs

| Line No. | Part No. | Size  | Lens               | Luminous Intensity at 20mA |         | Viewing Angle 2θ <sup>1/2</sup> | Forward Voltage at 20mA |         | Reverse Current (V <sub>R</sub> =5.0V) | Chromaticity Coordinates |        | Drawing |   |
|----------|----------|-------|--------------------|----------------------------|---------|---------------------------------|-------------------------|---------|--|--------------------------|--------|---------|---|
|          |          |       |                    | Minimum                    | Typical |                                 | Typical                 | Maximum |  | X Typ.                   | Y Typ. |         |   |
| ○ WHITE  | 1        | E1004 | T-1                | Clear                      | 700mcd  | 2800mcd                         | 25°                     | 3.6V    | 4.0V                                   | 50μA                     | 0.31   | 0.32    | A |
| ○ WHITE  | 2        | E1003 | T-1 <sup>3/4</sup> | Clear                      | 1400mcd | 5600mcd                         | 15°                     | 3.6V    | 4.0V                                   | 50μA                     | 0.31   | 0.32    | B |

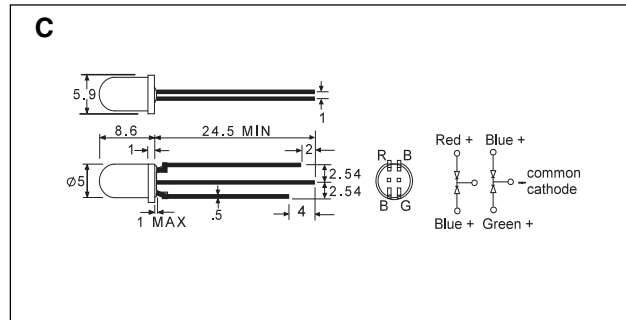

## T-1<sup>3/4</sup> Full Color LEDs

| Line No. | Part No. | Lens           | Luminous Intensity at 20mA |         | Viewing Angle 2θ <sup>1/2</sup> | Forward Voltage at 20mA |         | Peak Wave Length at 20mA | Drawing |
|----------|----------|----------------|----------------------------|---------|---------------------------------|-------------------------|---------|--------------------------|---------|
|          |          |                | Minimum                    | Maximum |                                 | Typical                 | Maximum |                          |         |
| ○ WHITE  | 3        | Clear          | 90mcd                      | 200mcd  | 15°                             | 2.0V                    | 2.5V    | 625nm                    | C       |
|          |          |                | 50mcd                      | 90mcd   | 15°                             | 2.2V                    | 2.5V    | 565nm                    |         |
|          |          |                | 12.5mcd                    | 40mcd   | 15°                             | 4.5V                    | 5.5V    | 430nm                    |         |
| ○ WHITE  | 4        | Diffused White | 20.0mcd                    | 90.0mcd | 30°                             | 2.0V                    | 2.5V    | 625nm                    | C       |
|          |          |                | 20.0mcd                    | 70.0mcd | 30°                             | 2.2V                    | 2.5V    | 565nm                    |         |
|          |          |                | 3.2mcd                     | 12.5mcd | 30°                             | 4.5V                    | 5.5V    | 430nm                    |         |



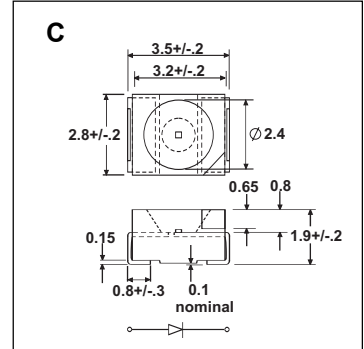
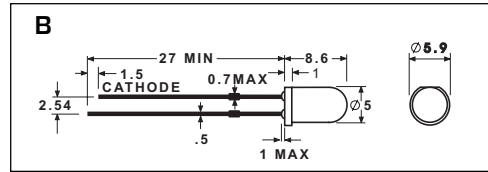
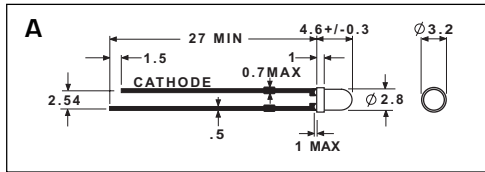

## T-1, T-1<sup>3/4</sup> and SMT Bright White LEDs

| Line No. | Part No. | Size  | Lens               | Luminous Intensity at 20mA |         | Viewing Angle 2θ <sup>1/2</sup> | Forward Voltage at 20mA |         | Reverse Current (V <sub>R</sub> =5.0V) | Chromaticity Coordinates |        | Drawing |   |
|----------|----------|-------|--------------------|----------------------------|---------|---------------------------------|-------------------------|---------|--|--------------------------|--------|---------|---|
|          |          |       |                    | Minimum                    | Typical |                                 | Typical                 | Maximum |  | X Typ.                   | Y Typ. |         |   |
| ○ WHITE  | 1        | E1007 | T-1                | Clear                      | 50mcd   | 180mcd                          | 50°                     | 3.8V    | 4.5V                                   | 10μA                     | 0.31   | 0.32    | A |
| ○ WHITE  | 2        | E1006 | T-1 <sup>3/4</sup> | Clear                      | 80mcd   | 200mcd                          | 30°                     | 3.8V    | 4.5V                                   | 10μA                     | 0.31   | 0.32    | B |
| ○ WHITE  | 3        | E1008 | SMT                | Clear                      | 90mcd   | 150mcd                          | 120°                    | 3.5V    | 4.0V                                   | 10μA                     | 0.31   | 0.32    | C |

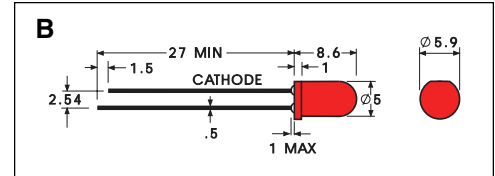
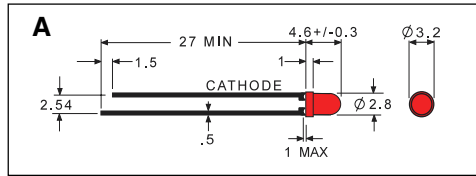

## T-1 and T-1<sup>3/4</sup> ,Ultra Bright, Red GaAlAs LEDs

| Line No. | Part No. | Size | Lens               | Luminous Intensity at 20mA |         | Viewing Angle 2θ <sup>1/2</sup> | Forward Voltage at 20mA |         | Peak Wave Length at 20mA | Drawing |   |
|----------|----------|------|--------------------|----------------------------|---------|---------------------------------|-------------------------|---------|--------------------------|---------|---|
|          |          |      |                    | Minimum                    | Maximum |                                 | Typical                 | Maximum |                          |         |   |
| ● RED    | 1        | E169 | T-1                | Clear                      | 360mcd  | 500mcd                          | 50°                     | 1.85V   | 2.50V                    | 660nm   | A |
| ● RED    | 2        | E170 | T-1                | Clear                      | 500mcd  | 700mcd                          | 50°                     | 1.85V   | 2.50V                    | 660nm   | A |
| ● RED    | 3        | E171 | T-1                | Clear                      | 700mcd  | 1000mcd                         | 50°                     | 1.85V   | 2.50V                    | 660nm   | A |
| ● RED    | 4        | E197 | T-1                | Clear                      | 1200mcd | 1400mcd                         | 50°                     | 1.85V   | 2.50V                    | 660nm   | A |
| ● RED    | 5        | E181 | T-1 <sup>3/4</sup> | Clear                      | 500mcd  | 1000mcd                         | 30°                     | 1.85V   | 2.5V                     | 660nm   | B |
| ● RED    | 6        | E183 | T-1 <sup>3/4</sup> | Clear                      | 1300mcd | 1600mcd                         | 30°                     | 1.85V   | 2.5V                     | 660nm   | B |
| ● RED    | 7        | E184 | T-1 <sup>3/4</sup> | Clear                      | 2000mcd | 3500mcd                         | 30°                     | 1.85V   | 2.5V                     | 660nm   | B |
| ● RED    | 8        | E301 | T-1 <sup>3/4</sup> | Diffused                   | 110mcd  | 200mcd                          | 60°                     | 1.85V   | 2.5V                     | 660nm   | B |
| ● RED    | 9        | E303 | T-1 <sup>3/4</sup> | Diffused                   | 200mcd  | 300mcd                          | 60°                     | 1.85V   | 2.5V                     | 660nm   | B |
| ● RED    | 10       | E304 | T-1 <sup>3/4</sup> | Diffused                   | 300mcd  | 500mcd                          | 60°                     | 1.85V   | 2.5V                     | 660nm   | B |

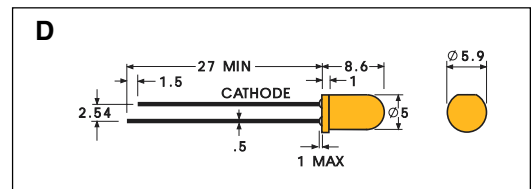
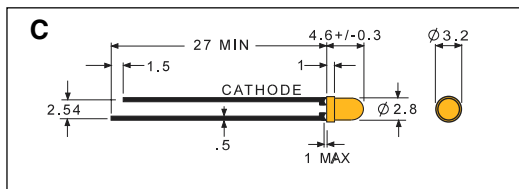

## T-1 and T-1<sup>3/4</sup>, Ultra Bright, Orange InGaAlP LEDs

| Line No. | Part No. | Size | Lens               | Luminous Intensity at 20mA |         | Viewing Angle 2θ <sup>1/2</sup> | Forward Voltage at 20mA |         | Peak Wave Length at 20mA | Drawing |   |
|----------|----------|------|--------------------|----------------------------|---------|---------------------------------|-------------------------|---------|--------------------------|---------|---|
|          |          |      |                    | Minimum                    | Maximum |                                 | Typical                 | Maximum |                          |         |   |
| ● ORANGE | 11       | E199 | T-1                | Orange Translucent         | 500mcd  | 1600mcd                         | 50°                     | 1.8V    | 2.3V                     | 620nm   | C |
| ● ORANGE | 12       | E194 | T-1 <sup>3/4</sup> | Orange Translucent         | 700mcd  | 3000mcd                         | 30°                     | 1.8V    | 2.3V                     | 620nm   | D |

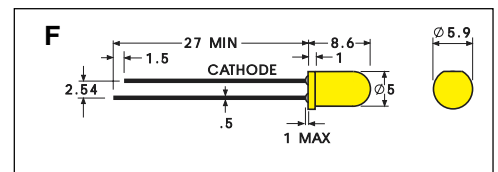
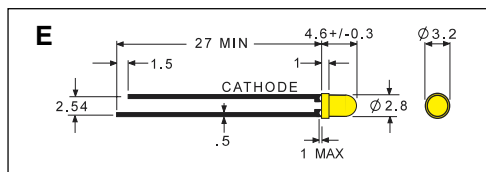

## T-1 and T-1<sup>3/4</sup>, Ultra Bright , Yellow InGaAlP LEDs

| Line No. | Part No. | Size | Lens               | Luminous Intensity at 20mA |         | Viewing Angle 2θ <sup>1/2</sup> | Forward Voltage at 20mA |         | Peak Wave Length at 20mA | Drawing |   |
|----------|----------|------|--------------------|----------------------------|---------|---------------------------------|-------------------------|---------|--------------------------|---------|---|
|          |          |      |                    | Minimum                    | Maximum |                                 | Typical                 | Maximum |                          |         |   |
| ● YELLOW | 13       | E198 | T-1                | Yellow Translucent         | 300mcd  | 1000mcd                         | 50°                     | 2.0V    | 2.5V                     | 595nm   | E |
| ● YELLOW | 14       | E195 | T-1 <sup>3/4</sup> | Yellow Translucent         | 400mcd  | 1600mcd                         | 30°                     | 2.0V    | 2.5V                     | 595nm   | F |

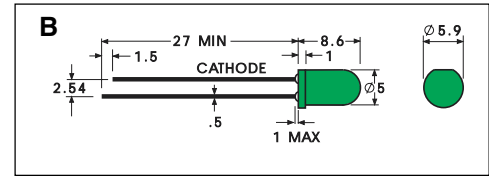
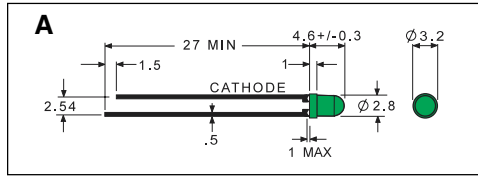

## T-1 and T-1<sup>3/4</sup>, Super Bright, Green GaP LEDs

|         | Line No. | Part No. | Size               | Lens     | Luminous Intensity at 20mA |         | Viewing Angle 2θ <sup>1/2</sup> | Forward Voltage at 20mA |         | Peak Wave Length at 20mA | Drawing |
|---------|----------|----------|--------------------|----------|----------------------------|---------|---------------------------------|-------------------------|---------|--------------------------|---------|
|         |          |          |                    |          | Minimum                    | Maximum |                                 | Typical                 | Maximum |                          |         |
| ● GREEN | 1        | E166     | T-1                | Clear    | 100mcd                     | 300mcd  | 50°                             | 2.2V                    | 2.5V    | 565nm                    | A       |
| ● GREEN | 2        | E196     | T-1                | Diffused | 40mcd                      | 60mcd   | 60°                             | 2.2V                    | 2.5V    | 565nm                    | A       |
| ● GREEN | 3        | E168     | T-1 <sup>3/4</sup> | Clear    | 100mcd                     | 200mcd  | 30°                             | 2.2V                    | 2.5V    | 565nm                    | B       |

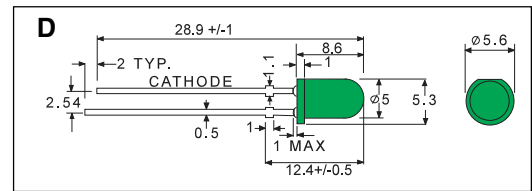
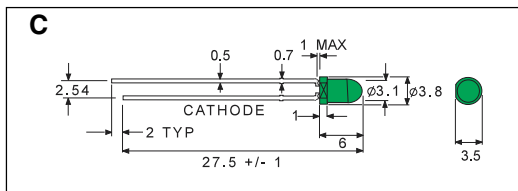

## T-1 and T-1<sup>3/4</sup>, Mega Bright Green, GaN LEDs

|         | Line No. | Part No. | Size               | Lens  | Luminous Intensity at 20mA |           | Viewing Angle 2θ <sup>1/2</sup> | Forward Voltage at 20mA |         | Reverse Current (V <sub>R</sub> =5.0V) | Peak Wave Length at 20mA | Drawing |
|---------|----------|----------|--------------------|-------|----------------------------|-----------|---------------------------------|-------------------------|---------|--|--------------------------|---------|
|         |          |          |                    |       | Minimum                    | Typical   |                                 | Typical                 | Maximum |  |                          |         |
| ● GREEN | 4        | E902     | T-1                | Clear | 2000mcd                    | 6800mcd   | 15°                             | 3.5V                    | 4.0V    | 50μA                                   | 525nm                    | C       |
| ● GREEN | 5        | E903     | T-1 <sup>3/4</sup> | Clear | 2500mcd                    | 10,000mcd | 15°                             | 3.5V                    | 4.0V    | 50μA                                   | 525nm                    | D       |

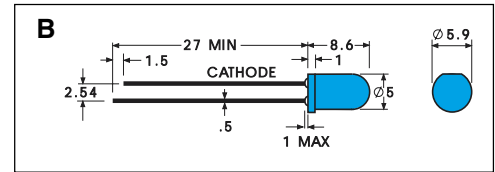
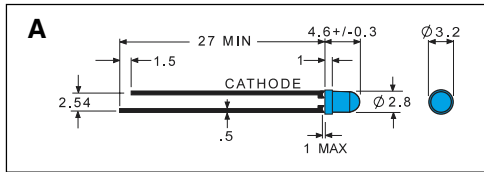

## T-1 and T-1<sup>3/4</sup>, Super Bright, Blue GaN LEDs

| Line No. | Part No. | Size | Lens               | Luminous Intensity at 20mA |         | Viewing Angle 2θ <sup>1/2</sup> | Forward Voltage at 20mA |         | Peak Wave Length at 20mA | Drawing |   |
|----------|----------|------|--------------------|----------------------------|---------|---------------------------------|-------------------------|---------|--------------------------|---------|---|
|          |          |      |                    | Minimum                    | Maximum |                                 | Typical                 | Maximum |                          |         |   |
| ● BLUE   | 1        | E472 | T-1                | Clear                      | 20.0mcd | 90.0mcd                         | 20°                     | 4.5V    | 5.5V                     | 430nm   | A |
| ● BLUE   | 2        | E474 | T-1 <sup>3/4</sup> | Clear                      | 60.0mcd | 150.0mcd                        | 16°                     | 4.5V    | 5.5V                     | 430nm   | B |

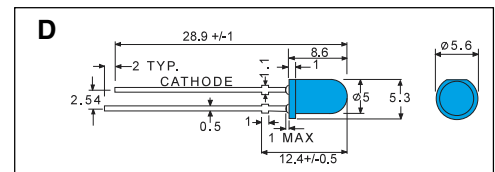
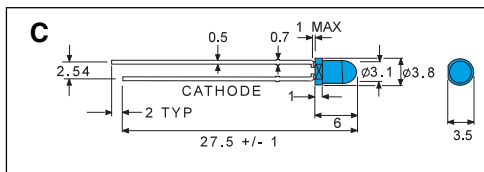

## T-1 and T-1<sup>3/4</sup>, Mega Bright Blue GaN LEDs

| Line No. | Part No. | Size | Lens               | Luminous Intensity at 20mA |         | Viewing Angle 2θ <sup>1/2</sup> | Forward Voltage at 20mA |         | Reverse Current (V <sub>R</sub> =5.0V) | Peak Wave Length at 20mA | Drawing |   |
|----------|----------|------|--------------------|----------------------------|---------|---------------------------------|-------------------------|---------|--|--------------------------|---------|---|
|          |          |      |                    | Minimum                    | Typical |                                 | Typical                 | Maximum |  |                          |         |   |
| ● BLUE   | 3        | E482 | T-1                | Clear                      | 500mcd  | 2000mcd                         | 15°                     | 3.6V    | 4.0V                                   | 50μA                     | 470nm   | C |
| ● BLUE   | 4        | E484 | T-1 <sup>3/4</sup> | Clear                      | 750mcd  | 3000mcd                         | 15°                     | 3.6V    | 4.0V                                   | 50μA                     | 470nm   | D |



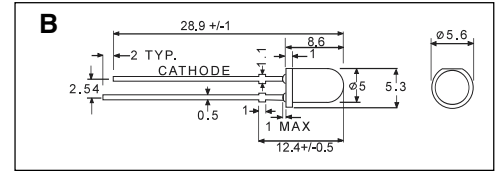
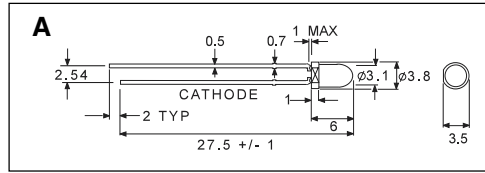

## T-1 and T-1<sup>3</sup>/<sub>4</sub>, Mega Bright White LEDs

|         | Line No. | Part No. | Size                            | Lens  | Luminous Intensity at 20mA |         | Viewing Angle 2θ <sup>1</sup> / <sub>2</sub> | Forward Voltage at 20mA |         | Reverse Current (V <sub>R</sub> =5.0V) | Chromaticity Coordinates |        | Drawing |
|---------|----------|----------|---------------------------------|-------|----------------------------|---------|--|-------------------------|---------|--|--------------------------|--------|---------|
|         |          |          |                                 |       | Minimum                    | Typical |  | Typical                 | Maximum |  | X Typ.                   | Y Typ. |         |
| ○ WHITE | 1        | E1004    | T-1                             | Clear | 700mcd                     | 2800mcd | 25°  | 3.6V                    | 4.0V    | 50μA                                   | 0.31                     | 0.32   | A       |
| ○ WHITE | 2        | E1003    | T-1 <sup>3</sup> / <sub>4</sub> | Clear | 1400mcd                    | 5600mcd | 15°  | 3.6V                    | 4.0V    | 50μA                                   | 0.31                     | 0.32   | B       |

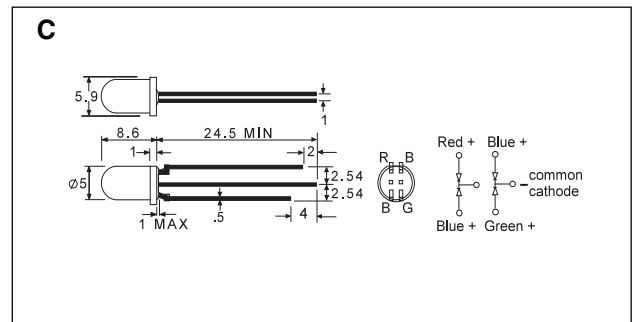

## T-1<sup>3</sup>/<sub>4</sub> Full Color LEDs

|         | Line No. | Part No. | Lens           | Luminous Intensity at 20mA |         | Viewing Angle 2θ <sup>1</sup> / <sub>2</sub> | Forward Voltage at 20mA |         | Peak Wave Length at 20mA | Drawing |
|---------|----------|----------|----------------|----------------------------|---------|--|-------------------------|---------|--------------------------|---------|
|         |          |          |                | Minimum                    | Maximum |  | Typical                 | Maximum |                          |         |
| ○ WHITE | 3        | E1000    | Clear          | 90mcd                      | 200mcd  | 15°  | 2.0V                    | 2.5V    | 625nm                    | C       |
|         |          |          |                | 50mcd                      | 90mcd   | 15°  | 2.2V                    | 2.5V    | 565nm                    |         |
|         |          |          |                | 12.5mcd                    | 40mcd   | 15°  | 4.5V                    | 5.5V    | 430nm                    |         |
| ○ WHITE | 4        | E1001    | Diffused White | 20.0mcd                    | 90.0mcd | 30°  | 2.0V                    | 2.5V    | 625nm                    | C       |
|         |          |          |                | 20.0mcd                    | 70.0mcd | 30°  | 2.2V                    | 2.5V    | 565nm                    |         |
|         |          |          |                | 3.2mcd                     | 12.5mcd | 30°  | 4.5V                    | 5.5V    | 430nm                    |         |

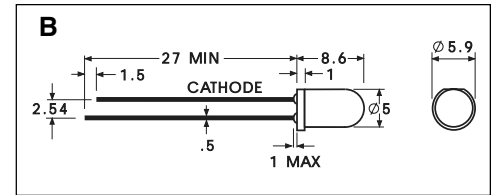
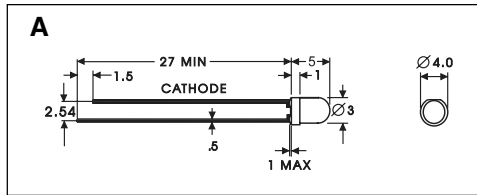

## T-1 and T-1<sup>3/4</sup>, Infrared LEDs: 880nm, 940nm

| Line No. | Part No. | Size | Lens               | Radiant Power at 20mA |          | Viewing Angle 2θ <sup>1/2</sup> | Forward Voltage at 20mA |         | Peak Wave Length at 20mA | Drawing |   |
|----------|----------|------|--------------------|-----------------------|----------|---------------------------------|-------------------------|---------|--------------------------|---------|---|
|          |          |      |                    | Minimum               | Typical  |                                 | Typical                 | Maximum |                          |         |   |
| INFRARED | 1        | E21  | T-1                | Clear                 | 2.0mW/sr | 10.0mW/sr                       | 30°                     | 1.2V    | 1.5V                     | 940nm   | A |
| INFRARED | 2        | E22  | T-1                | Trans.Blue            | 2.0mW/sr | 4.0mW/sr                        | 30°                     | 1.4V    | 1.7V                     | 880nm   | A |
| INFRARED | 3        | E23  | T-1 <sup>3/4</sup> | Clear                 | 8.0mW/sr | 20.0mW/sr                       | 30°                     | 1.2V    | 1.5V                     | 940nm   | B |
| INFRARED | 4        | E24  | T-1 <sup>3/4</sup> | Trans.Blue            | 5.0mW/sr | 20.0mW/sr                       | 30°                     | 1.4V    | 1.7V                     | 880nm   | B |

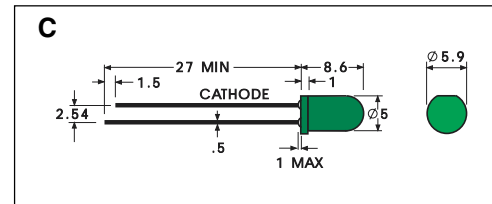

## T-1<sup>3/4</sup> LEDs with Resistor - 5V

| Line No. | Part No. | Lens    | Voltage Range |         | Luminous Intensity at 5VDC |         | Viewing Angle 2θ <sup>1/2</sup> | Current Range at 5VDC |         | Peak Wave Length at 5VDC | Drawing |   |
|----------|----------|---------|---------------|---------|----------------------------|---------|---------------------------------|-----------------------|---------|--------------------------|---------|---|
|          |          |         | Minimum       | Maximum | Minimum                    | Maximum |                                 | Minimum               | Maximum |                          |         |   |
| ● RED    | 5        | E304-5V | Diffused      | 4.0VDC  | 6.0VDC                     | 100mcd  | 300mcd                          | 60°                   | 8mA     | 15.5mA                   | 660nm   | C |
| ● RED    | 6        | E148-5V | Diffused      | 4.0VDC  | 6.0VDC                     | 5mcd    | 30mcd                           | 60°                   | 8mA     | 15.5mA                   | 625nm   | C |
| ● YELLOW | 7        | E149-5V | Diffused      | 4.0VDC  | 6.0VDC                     | 5mcd    | 20mcd                           | 60°                   | 8mA     | 15.5mA                   | 590nm   | C |
| ● GREEN  | 8        | E151-5V | Clear         | 4.0VDC  | 6.0VDC                     | 20mcd   | 150mcd                          | 30°                   | 8mA     | 15.5mA                   | 565nm   | C |
| ● GREEN  | 9        | E150-5V | Diffused      | 4.0VDC  | 6.0VDC                     | 5mcd    | 20mcd                           | 60°                   | 8mA     | 15.5mA                   | 565nm   | C |

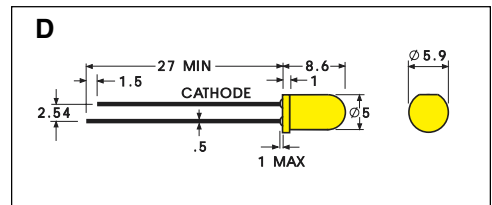

## T-1<sup>3/4</sup> LEDs with Resistor - 12V

| Line No. | Part No. | Lens     | Voltage Range |         | Luminous Intensity at 12VDC |         | Viewing Angle 2θ <sup>1/2</sup> | Current Range at 12VDC |         | Peak Wave Length at 12VDC | Drawing |   |
|----------|----------|----------|---------------|---------|-----------------------------|---------|---------------------------------|------------------------|---------|---------------------------|---------|---|
|          |          |          | Minimum       | Maximum | Minimum                     | Maximum |                                 | Minimum                | Maximum |                           |         |   |
| ● RED    | 10       | E304-12V | Diffused      | 9.5VDC  | 13.0VDC                     | 100mcd  | 300mcd                          | 60°                    | 8mA     | 15.5mA                    | 660nm   | D |
| ● YELLOW | 11       | E149-12V | Diffused      | 9.5VDC  | 13.0VDC                     | 5mcd    | 15mcd                           | 60°                    | 8mA     | 15.5mA                    | 590nm   | D |
| ● GREEN  | 12       | E151-12V | Diffused      | 9.5VDC  | 13.0VDC                     | 12mcd   | 20mcd                           | 60°                    | 8mA     | 15.5mA                    | 565nm   | D |

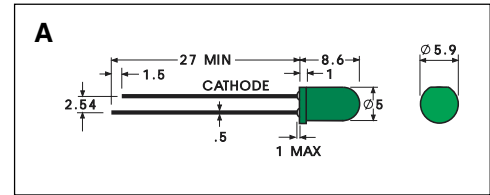

## T-1<sup>3/4</sup> Low Current LEDs (2mA)

|          | Line No. | Part No. | Lens     | Luminous Intensity at 2mA |         | Viewing Angle 2θ <sup>1/2</sup> | Forward Voltage at 20mA |         | Peak Wave Length at 20mA | Drawing |
|----------|----------|----------|----------|---------------------------|---------|---------------------------------|-------------------------|---------|--------------------------|---------|
|          |          |          |          | Minimum                   | Typical |                                 | Typical                 | Maximum |                          |         |
| ● RED    | 1        | E29      | Diffused | 8.0mcd                    | 20.0mcd | 60°                             | 1.85V                   | 2.5V    | 660nm                    | A       |
| ● RED    | 2        | E33      | Diffused | 0.8mcd                    | 2.0mcd  | 60°                             | 2.0V                    | 2.5V    | 625nm                    | A       |
| ● YELLOW | 3        | E34      | Diffused | 0.8mcd                    | 2.0mcd  | 60°                             | 2.1V                    | 2.5V    | 590nm                    | A       |
| ● GREEN  | 4        | E35      | Diffused | 0.8mcd                    | 2.0mcd  | 60°                             | 2.2V                    | 2.5V    | 565nm                    | A       |

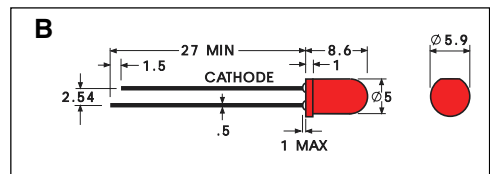

## T-1<sup>3/4</sup> Flashing LEDs

|          | Line No. | Part No. | Lens     | Forward D.C. Voltage |         |      | Forward Current (mA) |         |     | Luminous Intensity at 9.0 VDC |        | Viewing Angle 2θ <sup>1/2</sup> | Frequency (Hz) | Peak Wave Length | Drawing |
|----------|----------|----------|----------|----------------------|---------|------|----------------------|---------|-----|-------------------------------|--------|---------------------------------|----------------|------------------|---------|
|          |          |          |          | Min                  | Typical | Max  | Min                  | Typical | Max | Min                           | Max    |                                 |                |                  |         |
| ● RED    | 5        | E157     | Diffused | 3.5                  | 12.0    | 13.0 | 38                   | 56      | 70  | 100mcd                        | 300mcd | 60°                             | 2.5 - 1.5      | 660nm            | B       |
|          | 6        | E158     | Clear    | 3.5                  | 12.0    | 13.0 | 38                   | 56      | 70  | 400mcd                        | 900mcd | 30°                             | 2.5 - 1.5      | 660nm            | B       |
|          | 7        | E159     | Diffused | 3.5                  | 12.0    | 13.0 | 38                   | 56      | 70  | 20mcd                         | 80mcd  | 60°                             | 2.5 - 1.5      | 625nm            | B       |
| ● YELLOW | 8        | E160     | Diffused | 3.5                  | 12.0    | 13.0 | 38                   | 56      | 70  | 5mcd                          | 32mcd  | 60°                             | 2.5 - 1.5      | 590nm            | B       |
| ● GREEN  | 9        | E161     | Diffused | 3.5                  | 12.0    | 13.0 | 38                   | 56      | 70  | 5mcd                          | 32mcd  | 60°                             | 2.5 - 1.5      | 565nm            | B       |

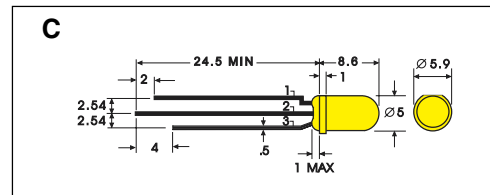

## T-1<sup>3/4</sup> Bi-Color LEDs (Very Bright)

|                  | Line No. | Part No. | Lens           | Luminous Intensity at 20mA |         | Viewing Angle 2θ <sup>1/2</sup> | Forward Voltage at 20mA |         | Peak Wave Length at 20mA | Leads  | Drawing |
|------------------|----------|----------|----------------|----------------------------|---------|---------------------------------|-------------------------|---------|--------------------------|--|---------|
|                  |          |          |                | Minimum                    | Maximum |                                 | Typical                 | Maximum |                          |  |         |
| ● RED & GREEN    | 10       | E203     | White Diffused | 20.0mcd                    | 90.0mcd | 60°                             | 2.0V                    | 2.5V    | 625nm                    | 1.Red Anode<br>2.Cathode<br>3.Green Anode    | C       |
| ● RED & GREEN    | 11       | E204     | White Diffused | 3.2mcd                     | 8.0mcd  | 60°                             | 2.0V                    | 2.5V    | 625nm                    | 1.Red Cathode<br>2.Anode<br>3.Green Cathode  | C       |
| ● RED & YELLOW   | 12       | E205     | White Diffused | 20.0mcd                    | 90.0mcd | 60°                             | 2.0V                    | 2.5V    | 625nm                    | 1.Red Anode<br>2.Cathode<br>3.Yellow Anode   | C       |
| ● GREEN & YELLOW | 13       | E206     | White Diffused | 20.0mcd                    | 70.0mcd | 60°                             | 2.2V                    | 2.5V    | 565nm                    | 1.Green Anode<br>2.Cathode<br>3.Yellow Anode | C       |

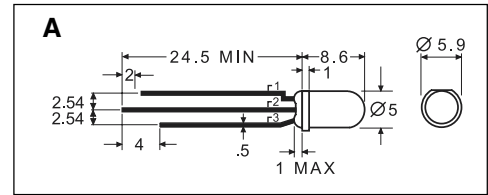

## T-1<sup>3/4</sup> Bi-Color Ultra Bright LEDs

|                 | Line No. | Part No. | Lens           | Luminous Intensity at 20mA |                  | Viewing Angle 2θ½ | Forward Voltage at 20mA |              | Peak Wave Length at 20mA | Leads  | Drawing |
|-----------------|----------|----------|----------------|----------------------------|------------------|-------------------|-------------------------|--------------|--------------------------|--|---------|
|                 |          |          |                | Minimum                    | Maximum          |                   | Typical                 | Maximum      |                          |  |         |
| ● RED & ● GREEN | 1        | E231     | White Diffused | 100mcd<br>40mcd            | 300mcd<br>80mcd  | 60°<br>60°        | 1.85V<br>2.20V          | 2.5V<br>2.5V | 660nm<br>565nm           | 1. Red Anode<br>2. Cathode<br>3. Green Anode   | A       |
| ● RED & ● GREEN | 2        | E232     | Clear          | 300mcd<br>80mcd            | 700mcd<br>200mcd | 30°<br>30°        | 1.85V<br>2.20V          | 2.5V<br>2.5V | 660nm<br>565nm           | 1. Red Anode<br>2. Cathode<br>3. Green Anode   | A       |
| ● RED & ● GREEN | 3        | E291     | Clear          | 300mcd<br>80mcd            | 700mcd<br>200mcd | 24°<br>24°        | 1.85V<br>2.20V          | 2.5V<br>2.5V | 660nm<br>565nm           | 1. Red Cathode<br>2. Anode<br>3. Green Cathode | A       |
| ● RED & ● GREEN | 4        | E292     | White Diffused | 100mcd<br>40mcd            | 300mcd<br>80mcd  | 24°<br>24°        | 1.85V<br>2.20V          | 2.5V<br>2.5V | 660nm<br>565nm           | 1. Red Cathode<br>2. Anode<br>3. Green Cathode | A       |

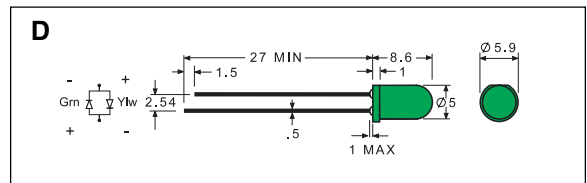
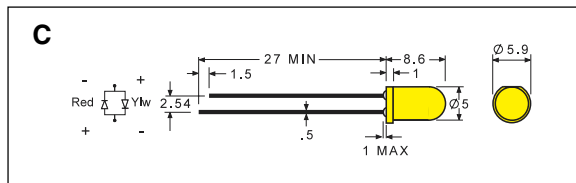
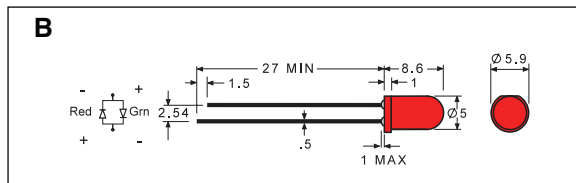

## T-1<sup>3/4</sup> Bi-Color LEDs (Two Leads)

|                    | Line No. | Part No. | Lens           | Luminous Intensity at 20mA |                | Viewing Angle 2θ½ | Forward Voltage at 20mA |              | Peak Wave Length at 20mA | Drawing |
|--------------------|----------|----------|----------------|----------------------------|----------------|-------------------|-------------------------|--------------|--------------------------|---------|
|                    |          |          |                | Minimum                    | Maximum        |                   | Typical                 | Maximum      |                          |         |
| ● RED & ● GREEN    | 5        | E210     | White Diffused | 20.0mcd<br>12.5mcd         | 50mcd<br>40mcd | 60°<br>60°        | 2.0V<br>2.2V            | 2.5V<br>2.5V | 625nm<br>565nm           | B       |
| ● RED & ● YELLOW   | 6        | E211     | White Diffused | 20mcd<br>5mcd              | 50mcd<br>20mcd | 60°<br>60°        | 2.0V<br>2.1V            | 2.5V<br>2.5V | 625nm<br>590nm           | C       |
| ● GREEN & ● YELLOW | 7        | E212     | White Diffused | 12.5mcd<br>5.0mcd          | 40mcd<br>20mcd | 60°<br>60°        | 2.2V<br>2.2V            | 2.5V<br>2.5V | 565nm<br>590nm           | D       |



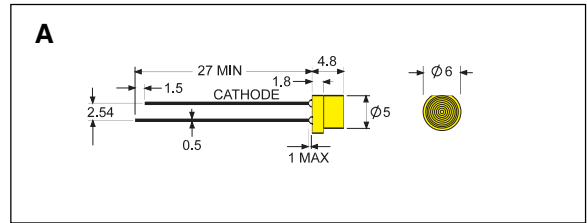

## T-1<sup>3/4</sup> Fresnel LEDs

|          | Line No. | Part No. | Lens     | Luminous Intensity at 20mA |         | Viewing Angle 2θ <sup>1/2</sup> | Forward Voltage at 20mA |         | Peak Wave Length at 20mA | Drawing |
|----------|----------|----------|----------|----------------------------|---------|---------------------------------|-------------------------|---------|--------------------------|---------|
|          |          |          |          | Minimum                    | Maximum |                                 | Typical                 | Maximum |                          |         |
| ● RED    | 1        | E276     | Diffused | 30.0mcd                    | 50.0mcd | 70°                             | 1.85V                   | 2.5V    | 660nm                    | A       |
| ● YELLOW | 2        | E277     | Diffused | 3.2mcd                     | 5.0mcd  | 70°                             | 2.1V                    | 2.5V    | 590nm                    | A       |
| ● GREEN  | 3        | E278     | Diffused | 3.2mcd                     | 5.0mcd  | 70°                             | 2.2V                    | 2.5V    | 565nm                    | A       |

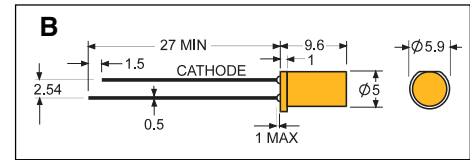

## T-1<sup>3/4</sup> Flat Top LEDs

|          | Line No. | Part No. | Lens     | Luminous Intensity at 10mA |         | Viewing Angle 2θ <sup>1/2</sup> | Forward Voltage at 20mA |         | Peak Wave Length at 20mA | Drawing |
|----------|----------|----------|----------|----------------------------|---------|---------------------------------|-------------------------|---------|--------------------------|---------|
|          |          |          |          | Minimum                    | Maximum |                                 | Typical                 | Maximum |                          |         |
| ● RED    | 4        | E270     | Diffused | 25.0mcd                    | 60.0mcd | 70°                             | 1.85V                   | 2.5V    | 660nm                    | B       |
| ● RED    | 5        | E271     | Diffused | 3.2mcd                     | 12.5mcd | 70°                             | 2.0V                    | 2.5V    | 625nm                    | B       |
| ● ORANGE | 6        | E272     | Diffused | 3.2mcd                     | 12.5mcd | 70°                             | 2.0V                    | 2.6V    | 610nm                    | B       |
| ● YELLOW | 7        | E273     | Diffused | 1.3mcd                     | 8.0mcd  | 70°                             | 2.1V                    | 2.5V    | 590nm                    | B       |
| ● GREEN  | 8        | E274     | Diffused | 5.0mcd                     | 20.0mcd | 80°                             | 2.2V                    | 2.5V    | 565nm                    | B       |

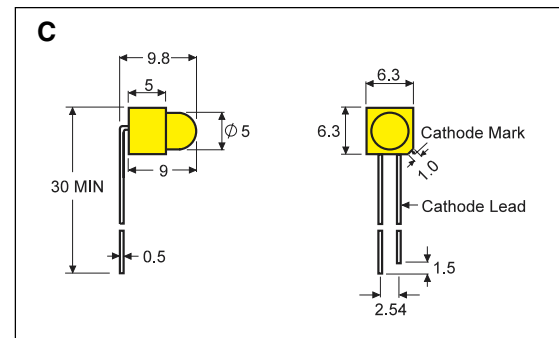

## T-1<sup>3/4</sup>, Right Angle Leads, LEDs (5mm)

|          | Line No. | Part No. | Lens     | Luminous Intensity at 10mA |         | Viewing Angle 2θ <sup>1/2</sup> | Forward Voltage at 20mA |         | Peak Wave Length at 20mA | Drawing |
|----------|----------|----------|----------|----------------------------|---------|---------------------------------|-------------------------|---------|--------------------------|---------|
|          |          |          |          | Minimum                    | Maximum |                                 | Typical                 | Maximum |                          |         |
| ● RED    | 9        | E241     | Diffused | 12.5mcd                    | 32.0mcd | 60°                             | 2.0V                    | 2.5V    | 625nm                    | C       |
| ● ORANGE | 10       | E242     | Diffused | 12.5mcd                    | 32.0mcd | 60°                             | 2.0V                    | 2.6V    | 610nm                    | C       |
| ● YELLOW | 11       | E244     | Diffused | 5.0mcd                     | 20.0mcd | 60°                             | 2.1V                    | 2.5V    | 590nm                    | C       |
| ● GREEN  | 12       | E246     | Diffused | 5.0mcd                     | 20.0mcd | 60°                             | 2.2V                    | 2.5V    | 565nm                    | C       |