



FIVE OUTPUT 3.3V CLOCK BUFFER

IDT2305NZ

FEATURES:

- One input to five output buffer/driver
- Low power consumption for mobile applications: less than 32mA at 66.6MHz with unloaded outputs
- 8.7ns max input-output delay
- Buffers all frequencies from DC to 133.33MHz
- Output-output skew < 250ps
- 3.3V operation
- High drive capability
- Available in SOIC package

DESCRIPTION:

The IDT2305NZ is a low-cost buffer designed to distribute high-speed clocks in mobile PC systems and desktop PC systems. The IDT2305NZ operates at 3.3V with five outputs that can run up to 133.33MHz

The IDT2305NZ is an 8-pin version of the IDT2309NZ. It is designed for low EMI and power optimization and consumes less than 32mA at 66.6MHz, making it ideal for the low power requirements of mobile systems.

FUNCTIONAL BLOCK DIAGRAM

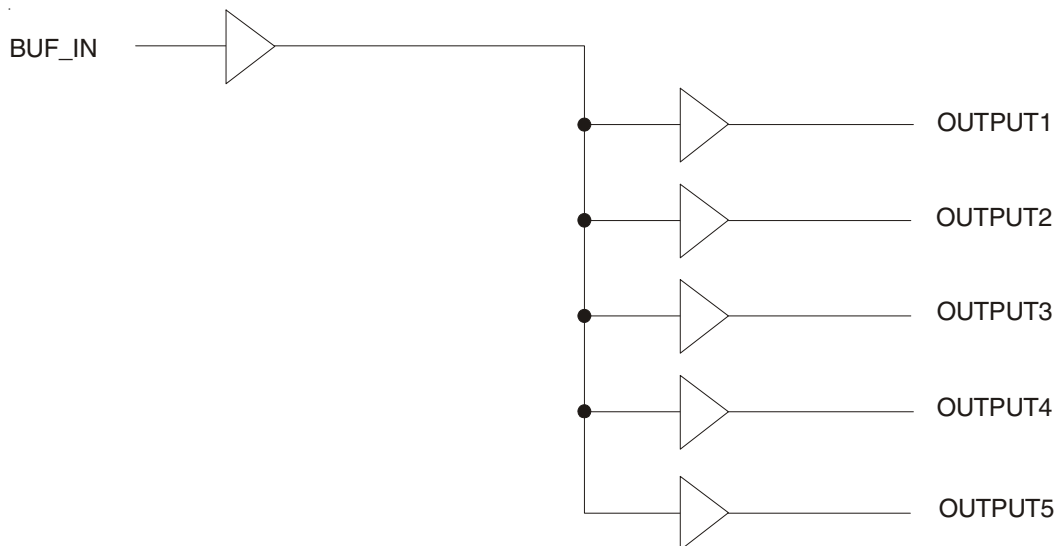

PIN CONFIGURATION

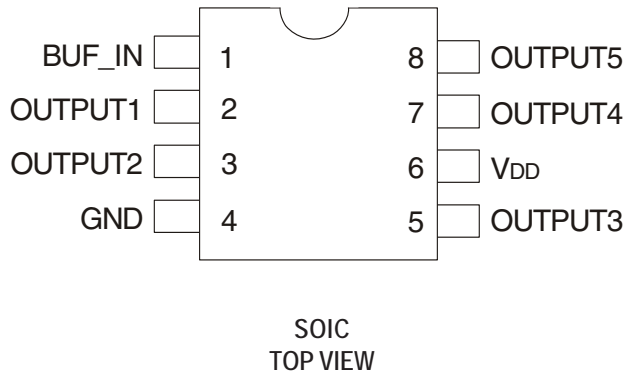

ABSOLUTE MAXIMUM RATINGS⁽¹⁾

Symbol	Rating	Max.	Unit
V _{DD}	Supply Voltage Range	-0.5 to +4.6	V
V _I ⁽²⁾	Input Voltage Range (REF)	-0.5 to +5.5	V
V _I	Input Voltage Range (except REF)	-0.5 to V _{DD} +0.5	V
I _{IK} (V _I < 0)	Input Clamp Current	-50	mA
I _O (V _O = 0 to V _{DD})	Continuous Output Current	±50	mA
V _{DD} or GND	Continuous Current	±100	mA
T _A = 55°C (in still air) ⁽³⁾	Maximum Power Dissipation	0.7	W
T _{STG}	Storage Temperature Range	-65 to +150	°C
Operating Temperature	Commercial Temperature Range	0 to +70	°C
Operating Temperature	Industrial Temperature Range	-40 to +85	°C

NOTES:

1. Stresses greater than those listed under ABSOLUTE MAXIMUM RATINGS may cause permanent damage to the device. This is a stress rating only and functional operation of the device at these or any other conditions above those indicated in the operational sections of this specification is not implied. Exposure to absolute maximum rating conditions for extended periods may affect reliability.
2. The input and output negative-voltage ratings may be exceeded if the input and output clamp-current ratings are observed.
3. The maximum package power dissipation is calculated using a junction temperature of 150°C and a board trace length of 750 mils.

PIN DESCRIPTION

Pin Name	Pin Number	Functional Description
V _{DD}	6	3.3V Digital Voltage Supply
GND	4	Ground
BUF_IN	1	Input clock
OUTPUT _[1:5]	2, 3, 6, 7, 10	Outputs

OPERATING CONDITIONS - COMMERCIAL

Symbol	Parameter	Min.	Max.	Unit
V _{DD}	Supply Voltage	3	3.6	V
T _A	Operating Temperature (Ambient Temperature)	0	70	°C
C _L	Load Capacitance, F _{OUT} < 100MHz	—	30	pF
	Load Capacitance 100MHz < F _{OUT} < 133.33MHz	—	15	
C _{IN}	Input Capacitance	—	7	pF
BUF_IN, OUTPUT _[1:5]	Operating Frequency	DC	133.33	MHz

OPERATING CONDITIONS - INDUSTRIAL

Symbol	Parameter	Min.	Max.	Unit
V _{DD}	Supply Voltage	3	3.6	V
T _A	Operating Temperature (Ambient Temperature)	-40	+85	°C
C _L	Load Capacitance, F _{OUT} < 100MHz	—	30	pF
	Load Capacitance 100MHz < F _{OUT} < 133.33MHz	—	15	
C _{IN}	Input Capacitance	—	7	pF
BUF_IN, OUTPUT _[1:5]	Operating Frequency	DC	133.33	MHz

DC ELECTRICAL CHARACTERISTICS - COMMERCIAL

Symbol	Parameter	Conditions	Min.	Max.	Unit
V _{IL}	Input LOW Voltage ⁽¹⁾		—	0.8	V
V _{IH}	Input HIGH Voltage ⁽¹⁾		2	—	V
I _{IL}	Input LOW Current	V _{IN} = 0V	—	50	μA
I _{IH}	Input HIGH Current	V _{IN} = V _{DD}	—	100	μA
V _{OL}	Output LOW Voltage ⁽²⁾	I _{OL} = 12mA	—	0.4	V
V _{OH}	Output HIGH Voltage ⁽²⁾	I _{OH} = -12mA	2.4	—	V
I _{DD}	Supply Current	Unloaded Outputs at 66.66MHz	—	32	mA

NOTES:

1. BUF_IN input has a threshold voltage of V_{DD}/2.
2. Parameter is guaranteed by design but not production tested.

DC ELECTRICAL CHARACTERISTICS - INDUSTRIAL

Symbol	Parameter	Conditions	Min.	Max.	Unit
V _{IL}	Input LOW Voltage ⁽¹⁾		—	0.8	V
V _{IH}	Input HIGH Voltage ⁽¹⁾		2	—	V
I _{IL}	Input LOW Current	V _{IN} = 0V	—	50	μA
I _{IH}	Input HIGH Current	V _{IN} = V _{DD}	—	100	μA
V _{OL}	Output LOW Voltage ⁽²⁾	I _{OL} = 12mA	—	0.4	V
V _{OH}	Output HIGH Voltage ⁽²⁾	I _{OH} = -12mA	2.4	—	V
I _{DD}	Supply Current	Unloaded Outputs at 66.66MHz	—	35	mA

NOTES:

1. BUF_IN input has a threshold voltage of V_{DD}/2.
2. Parameter is guaranteed by design but not production tested.

SWITCHING CHARACTERISTICS - COMMERCIAL⁽¹⁾

Symbol	Parameter ⁽²⁾	Conditions	Min.	Typ.	Max.	Unit
t _r	Rise Time	Measured between 0.8V and 2V	—	—	1.5	ns
t _f	Fall Time	Measured between 0.8V and 2V	—	—	1.5	ns
t _s	Output to Output Skew	All outputs equally loaded	—	—	250	ps
t _p	Propagation Delay, BUF_IN Rising Edge to OUTPUT Rising Edge	Measured at V _{DD} /2	1	5	8.7	ns
DC	Duty Cycle	Measured at V _{DD} /2	45	—	55	%

NOTES:

1. All parameters specified with loaded outputs.
2. Parameter is guaranteed by design but not production tested.

SWITCHING CHARACTERISTICS - INDUSTRIAL ⁽¹⁾

Symbol	Parameter ⁽²⁾	Conditions	Min.	Typ.	Max.	Unit
t_3	Rise Time	Measured between 0.8V and 2V	—	—	1.5	ns
t_4	Fall Time	Measured between 0.8V and 2V	—	—	1.5	ns
t_5	Output to Output Skew	All outputs equally loaded	—	—	250	ps
t_6	Propagation Delay, BUF_IN Rising Edge to OUTPUT Rising Edge	Measured at $V_{DD}/2$	1	5	8.7	ns
DC	Duty Cycle	Measured at $V_{DD}/2$	45	—	55	%

NOTES:

1. All parameters specified with loaded outputs.
2. Parameter is guaranteed by design but not production tested.

SWITCHING WAVEFORMS

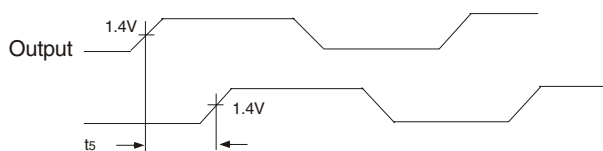

Output to Output Skew

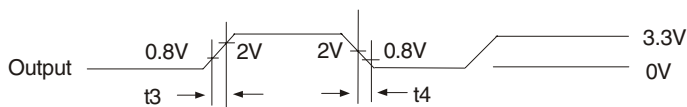

All Outputs Rise/Fall Time

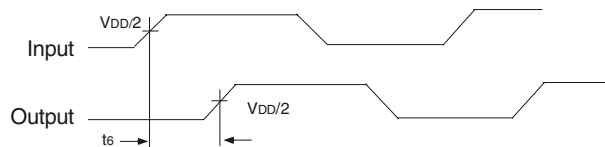

Input to Output Propagation Delay

TEST CIRCUIT

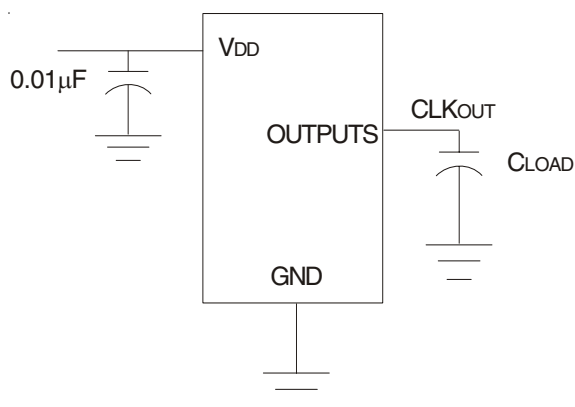

ORDERING INFORMATION

IDT XXXXX XX X
Device Type Package Process

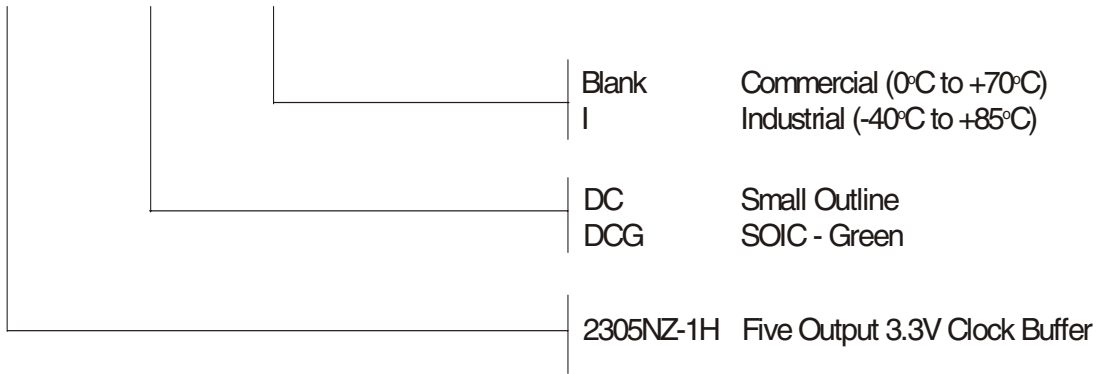

CORPORATE HEADQUARTERS
6024 Silver Creek Valley Road
San Jose, CA 95138

for SALES:
800-345-7015 or 408-284-8200
fax: 408-284-2775
www.idt.com

for Tech Support:
clockhelp@idt.com