

HAL556, HAL560,  
HAL566  
Two-Wire Hall Effect  
Sensor Family

## Contents

Page	Section	Title
<b>3</b>	<b>1.</b>	<b>Introduction</b>
3	1.1.	Features
3	1.2.	Family Overview
4	1.3.	Marking Code
4	1.4.	Operating Junction Temperature Range
4	1.5.	Hall Sensor Package Codes
4	1.6.	Solderability
<b>5</b>	<b>2.</b>	<b>Functional Description</b>
<b>6</b>	<b>3.</b>	<b>Specifications</b>
6	3.1.	Outline Dimensions
6	3.2.	Dimensions of Sensitive Area
6	3.3.	Positions of Sensitive Areas
7	3.4.	Absolute Maximum Ratings
7	3.5.	Recommended Operating Conditions
8	3.6.	Electrical Characteristics
9	3.7.	Magnetic Characteristics Overview
<b>12</b>	<b>4.</b>	<b>Type Descriptions</b>
12	4.1.	HAL556
14	4.2.	HAL560
16	4.3.	HAL566
<b>18</b>	<b>5.</b>	<b>Application Notes</b>
18	5.1.	Application Circuit
18	5.2.	Extended Operating Conditions
18	5.3.	Start-up Behavior
19	5.4.	Ambient Temperature
19	5.5.	EMC and ESD
<b>20</b>	<b>6.</b>	<b>Data Sheet History</b>

## Two-Wire Hall Effect Sensor Family in CMOS technology

**Release Notes: Revision bars indicate significant changes to the previous edition.**

### 1. Introduction

This sensor family consists of different two-wire Hall switches produced in CMOS technology. All sensors change the current consumption depending on the external magnetic field and require only two wires between sensor and evaluation circuit. The sensors of this family differ in the magnetic switching behavior and switching points.

The sensors include a temperature-compensated Hall plate with active offset compensation, a comparator, and a current source. The comparator compares the actual magnetic flux through the Hall plate (Hall voltage) with the fixed reference values (switching points). Accordingly, the current source is switched on (high current consumption) or off (low current consumption).

The active offset compensation leads to constant magnetic characteristics in the full supply voltage and temperature range. In addition, the magnetic parameters are robust against mechanical stress effects.

The sensors are designed for industrial and automotive applications and operate with supply voltages from 4 V to 24 V in the junction temperature range from  $-40\text{ }^{\circ}\text{C}$  up to  $170\text{ }^{\circ}\text{C}$ . All sensors are available in the SMD-package SOT-89B and in the leaded version TO-92UA.

#### 1.1. Features:

- current output for two-wire applications
- junction temperature range from  $-40\text{ }^{\circ}\text{C}$  up to  $170\text{ }^{\circ}\text{C}$ .
- operates from 4 V to 24 V supply voltage
- operates with static magnetic fields and dynamic magnetic fields up to 10 kHz
- switching offset compensation at typically 145 kHz
- overvoltage and reverse-voltage protection
- magnetic characteristics are robust against mechanical stress effects
- constant magnetic switching points over a wide supply voltage range
- the decrease of magnetic flux density caused by rising temperature in the sensor system is compensated by a built-in negative temperature coefficient of the magnetic characteristics
- ideal sensor for applications in extreme automotive and industrial environments
- EMC corresponding to DIN 40839

### 1.2. Family Overview

The types differ according to the mode of switching and the magnetic switching points.

Type	Switching Behavior	Sensitivity	see Page
556	unipolar	very high	12
560	unipolar inverted	low	14
566	unipolar inverted	very high	16

#### Unipolar Switching Sensors:

The sensor turns to high current consumption with the magnetic south pole on the branded side of the package and turns to low consumption if the magnetic field is removed. The sensor does not respond to the magnetic north pole on the branded side.

#### Unipolar Inverted Switching Sensors:

The sensor turns to low current consumption with the magnetic south pole on the branded side of the package and turns to high consumption if the magnetic field is removed. The sensor does not respond to the magnetic north pole on the branded side.

# HAL55x, HAL56x

## 1.3. Marking Code

All Hall sensors have a marking on the package surface (branded side). This marking includes the name of the sensor and the temperature range.

Type	Temperature Range		
	A	K	E
HAL556	556A	556K	556E
HAL560	560A	560K	560E
HAL566	566A	566K	566E

## 1.4. Operating Junction Temperature Range

The Hall sensors from Micronas are specified to the chip temperature (junction temperature  $T_J$ ).

**A:**  $T_J = -40\text{ °C to }+170\text{ °C}$

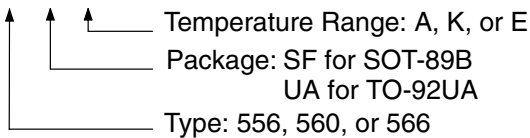
**K:**  $T_J = -40\text{ °C to }+140\text{ °C}$

**E:**  $T_J = -40\text{ °C to }+100\text{ °C}$

**Note:** Due to the high power dissipation at high current consumption, there is a difference between the ambient temperature ( $T_A$ ) and junction temperature. Please refer section 5.4. on page 19 for details.

## 1.5. Hall Sensor Package Codes

HALXXXPA-T



Example: **HAL556UA-E**

→ Type: 556

→ Package: TO-92UA

→ Temperature Range:  $T_J = -40\text{ °C to }+100\text{ °C}$

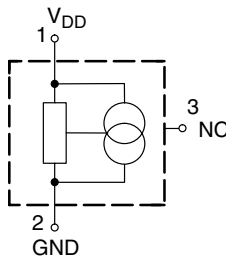
Hall sensors are available in a wide variety of packaging versions and quantities. For more detailed information, please refer to the brochure: "Ordering Codes for Hall Sensors".

## 1.6. Solderability

all packages: according to IEC68-2-58

During soldering reflow processing and manual reworking, a component body temperature of  $260\text{ °C}$  should not be exceeded.

Components stored in the original packaging should provide a shelf life of at least 12 months, starting from the date code printed on the labels, even in environments as extreme as  $40\text{ °C}$  and 90% relative humidity.



**Fig. 1-1:** Pin configuration

## 2. Functional Description

The HAL55x, HAL56x two-wire sensors are monolithic integrated circuits which switch in response to magnetic fields. If a magnetic field with flux lines perpendicular to the sensitive area is applied to the sensor, the biased Hall plate forces a Hall voltage proportional to this field. The Hall voltage is compared with the actual threshold level in the comparator. The temperature-dependent bias increases the supply voltage of the Hall plates and adjusts the switching points to the decreasing induction of magnets at higher temperatures.

If the magnetic field exceeds the threshold levels, the current source switches to the corresponding state. In the low current consumption state, the current source is switched off and the current consumption is caused only by the current through the Hall sensor. In the high current consumption state, the current source is switched on and the current consumption is caused by the current through the Hall sensor and the current source. The built-in hysteresis eliminates oscillation and provides switching behavior of the output signal without bouncing.

Magnetic offset caused by mechanical stress is compensated for by using the “switching offset compensation technique”. An internal oscillator provides a two-phase clock. In each phase, the current is forced through the Hall plate in a different direction, and the Hall voltage is measured. At the end of the two phases, the Hall voltages are averaged and thereby the offset voltages are eliminated. The average value is compared with the fixed switching points. Subsequently, the current consumption switches to the corresponding state. The amount of time elapsed from crossing the magnetic switching level to switching of the current level can vary between zero and  $1/f_{osc}$ .

Shunt protection devices clamp voltage peaks at the  $V_{DD}$ -pin together with external series resistors. Reverse current is limited at the  $V_{DD}$ -pin by an internal series resistor up to  $-15$  V. No external protection diode is needed for reverse voltages ranging from 0 V to  $-15$  V.

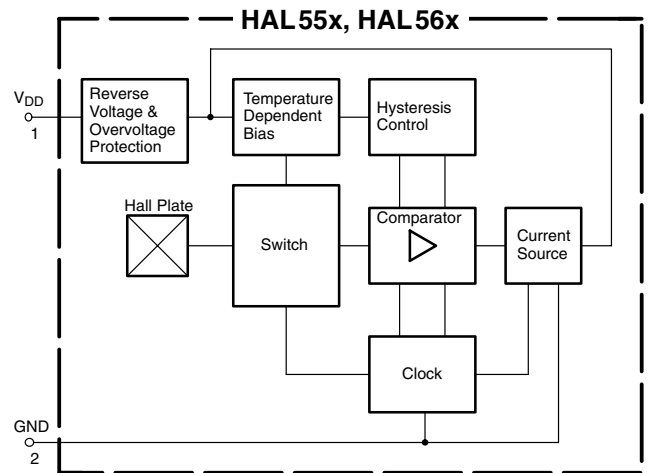


Fig. 2-1: HAL55x, HAL56x block diagram

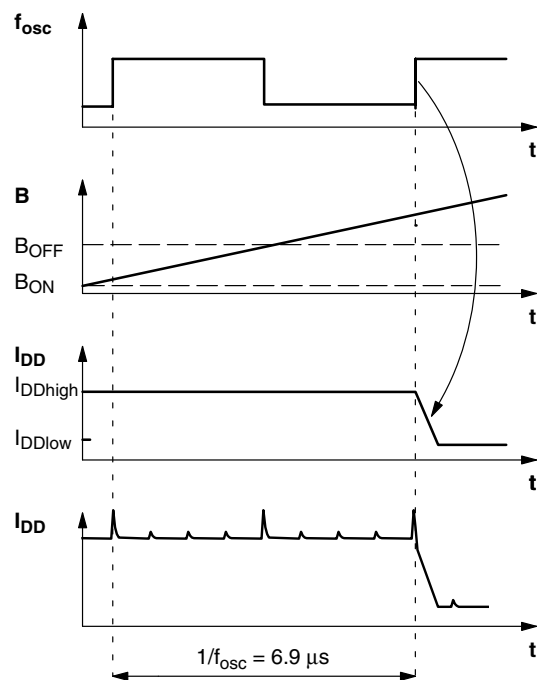
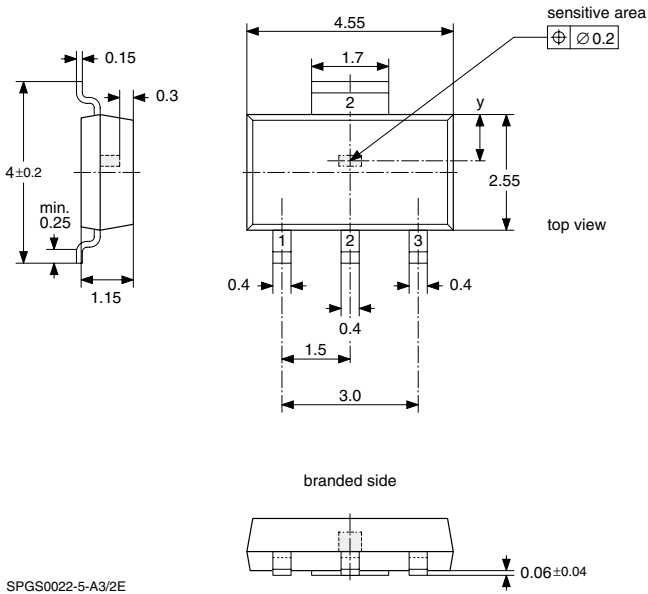


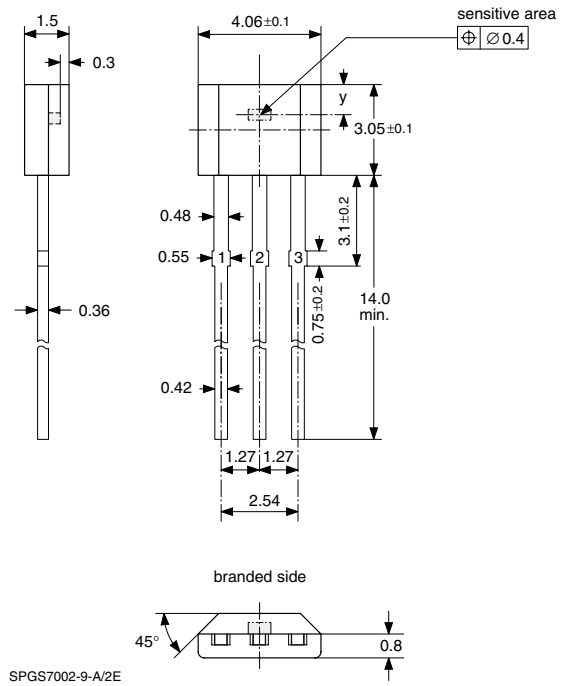
Fig. 2-2: Timing diagram (example: HAL56x)

## 3. Specifications

### 3.1. Outline Dimensions



**Fig. 3-1:**  
Plastic Small Outline Transistor Package  
(SOT-89B)  
Weight approximately 0.035 g  
Dimensions in mm



**Fig. 3-2:**  
Plastic Transistor Single Outline Package  
(TO-92UA)  
Weight approximately 0.12 g  
Dimensions in mm

### 3.2. Dimensions of Sensitive Area

0.25 mm x 0.12 mm

### 3.3. Positions of Sensitive Areas

	SOT-89B	TO-92UA
x	center of the package	center of the package
y	0.85 mm nominal	0.9 mm nominal

**Note:** For all package diagrams, a mechanical tolerance of  $\pm 0.05$  mm applies to all dimensions where no tolerance is explicitly given.

The improvement of the TO-92UA package with the reduced tolerances will be introduced end of 2001.

### 3.4. Absolute Maximum Ratings

Symbol	Parameter	Pin No.	Min.	Max.	Unit
$V_{DD}$	Supply Voltage	1	-15 <sup>1)</sup> 2)	28 <sup>2)</sup>	V
$I_{DDZ}$	Supply Current through Protection Device	1	-50 <sup>2)</sup> -200 <sup>3)</sup>	50 <sup>2)</sup> 200 <sup>3)</sup>	mA mA
$T_S$	Storage Temperature Range		-65	150	°C
$T_J$	Junction Temperature Range		-40 -40	150 170 <sup>4)</sup>	°C

1) -18 V with a 100  $\Omega$  series resistor at pin 1 (-16 V with a 30  $\Omega$  series resistor)  
 2) as long as  $T_{Jmax}$  is not exceeded  
 2) with a 220  $\Omega$  series resistance at pin 1 corresponding to test circuit 1 (see Fig. 5-3)  
 3)  $t < 2$  ms  
 4)  $t < 1000$  h

Stresses beyond those listed in the “Absolute Maximum Ratings” may cause permanent damage to the device. This is a stress rating only. Functional operation of the device at these or any other conditions beyond those indicated in the “Recommended Operating Conditions/Characteristics” of this specification is not implied. Exposure to absolute maximum ratings conditions for extended periods may affect device reliability.

### 3.5. Recommended Operating Conditions

Symbol	Parameter	Pin No.	Min.	Max.	Unit
$V_{DD}$	Supply Voltage	1	4	24	V
$T_A$	Ambient Temperature for continuous operation		-40 -40	85 <sup>1)</sup> 125 <sup>2)</sup>	°C °C
$t_{on}$	Supply Time for pulsed mode		30	-	$\mu$ s

1) when using the “A” type or the “K” type and  $V_{DD} \leq 16$  V  
 2) when using the “A” type and  $V_{DD} \leq 13.2$  V

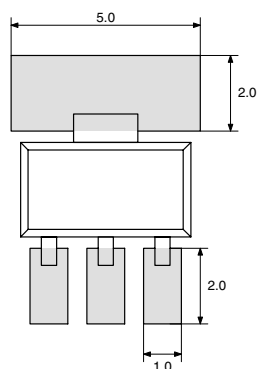
**Note:** Due to the high power dissipation at high current consumption, there is a difference between the ambient temperature ( $T_A$ ) and junction temperature. The power dissipation can be reduced by repeatedly switching the supply voltage on and off (pulse mode). Please refer to section 5.4. on page 19 for details.

# HAL55x, HAL56x

## 3.6. Electrical Characteristics at $T_J = -40\text{ }^\circ\text{C}$ to $+170\text{ }^\circ\text{C}$ , $V_{DD} = 4\text{ V}$ to $24\text{ V}$ , as not otherwise specified in Conditions Typical Characteristics for $T_J = 25\text{ }^\circ\text{C}$ and $V_{DD} = 12\text{ V}$

Symbol	Parameter	Pin No.	Min.	Typ.	Max.	Unit	Conditions
$I_{DDlow}$	Low Current Consumption over Temperature Range	1	2	3.3	5	mA	
$I_{DDhigh}$	High Current Consumption over Temperature Range	1	12	14.3	17	mA	
$V_{DDZ}$	Overshoot Protection at Supply	1	–	28.5	32	V	$I_{DD} = 25\text{ mA}$ , $T_J = 25\text{ }^\circ\text{C}$ , $t = 20\text{ ms}$
$f_{osc}$	Internal Oscillator Chopper Frequency	–	90	145	–	kHz	$T_J = 25\text{ }^\circ\text{C}$
$f_{osc}$	Internal Oscillator Chopper Frequency over Temperature Range	–	75	145	–	kHz	
$t_{en(O)}$	Enable Time of Output after Setting of $V_{DD}$	1		20	30	$\mu\text{s}$	1)
$t_r$	Output Rise Time	1		0.4	1.6	$\mu\text{s}$	$V_{DD} = 12\text{ V}$ , $R_S = 30\ \Omega$
$t_f$	Output Fall Time	1		0.4	1.6	$\mu\text{s}$	$V_{DD} = 12\text{ V}$ , $R_S = 30\ \Omega$
$R_{thJSB}$ case SOT-89B	Thermal Resistance Junction to Substrate Backside	–	–	150	200	K/W	Fiberglass Substrate 30 mm x 10 mm x 1.5mm, pad size see Fig. 3–3
$R_{thJA}$ case TO-92UA	Thermal Resistance Junction to Soldering Point	–	–	150	200	K/W	

1)  $B > B_{ON} + 2\text{ mT}$  or  $B < B_{OFF} - 2\text{ mT}$  for HAL55x,  $B > B_{OFF} + 2\text{ mT}$  or  $B < B_{ON} - 2\text{ mT}$  for HAL56x



**Fig. 3–3:** Recommended pad size SOT-89B  
Dimensions in mm



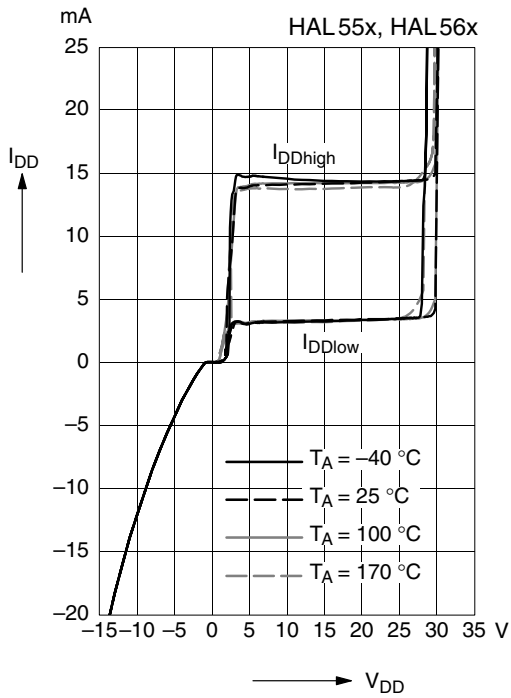
**3.7. Magnetic Characteristics Overview** at  $T_J = -40\text{ °C}$  to  $+170\text{ °C}$ ,  $V_{DD} = 4\text{ V}$  to  $24\text{ V}$ ,  
Typical Characteristics for  $V_{DD} = 12\text{ V}$

Magnetic flux density values of switching points.

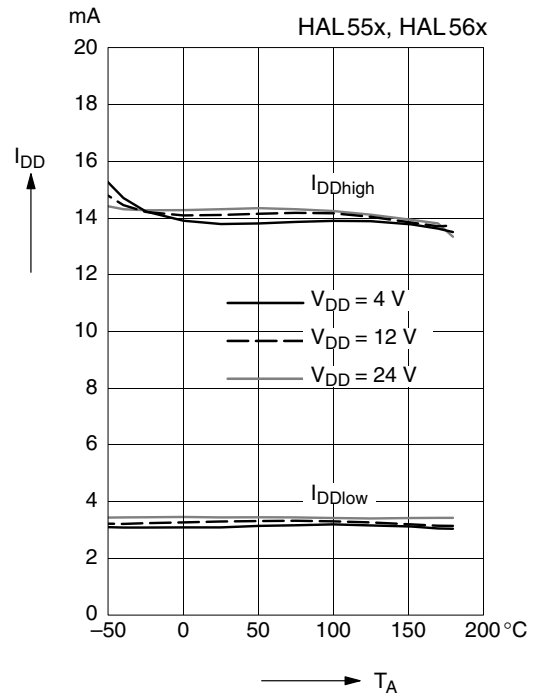
Positive flux density values refer to the magnetic south pole at the branded side of the package.

Sensor Switching Type	Parameter $T_J$	On point $B_{ON}$			Off point $B_{OFF}$			Hysteresis $B_{HYS}$			Unit
		Min.	Typ.	Max.	Min.	Typ.	Max.	Min.	Typ.	Max.	
HAL 556 unipolar	-40 °C	3.4	6.3	7.7	2.1	4.2	5.9	0.8	2.1	3	mT
	25 °C	3.4	6	7.4	2	3.8	5.7	0.5	1.8	2.8	mT
	100 °C	3.2	5.5	7.2	1.9	3.7	5.7	0.3	1.8	2.8	mT
	170 °C	2.8	5	7.6	1	3.5	6.2	0.2	1.5	3.2	mT
HAL 560 unipolar inverted	-40 °C	41	46.5	52	47	53	59	4	6.5	10	mT
	25 °C	41	46.6	52	46	52.5	58.5	3	6	9	mT
	100 °C	41	45.7	52	45	41.1	57.5	2	5.4	8	mT
	170 °C	38	44.2	50	42	49	55.5	2	4.8	8	mT
HAL 566 unipolar inverted	-40 °C	2.1	4	5.9	3.4	6	7.7	0.8	2	2.8	mT
	25 °C	2	3.9	5.7	3.4	5.9	7.2	0.5	2	2.7	mT
	100 °C	1.85	3.8	5.7	3.25	5.6	7	0.3	1.8	2.6	mT
	170 °C	1	3.4	6.3	2.2	4.8	7.6	0.2	1.4	3	mT

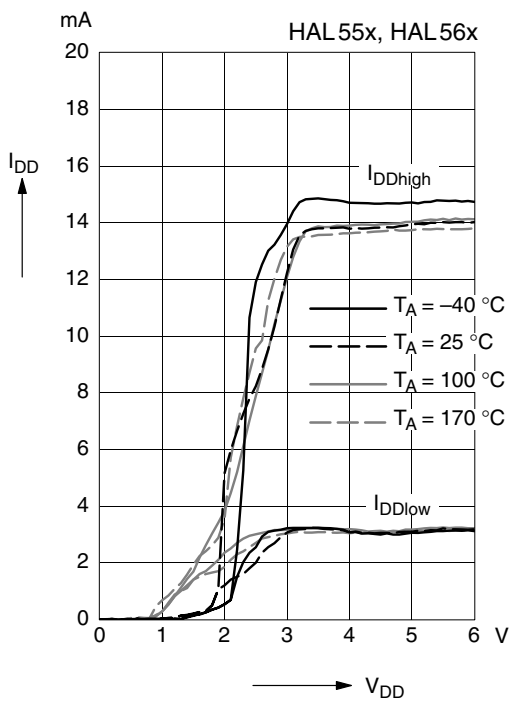
**Note:** For detailed descriptions of the individual types, see pages 12 and following.



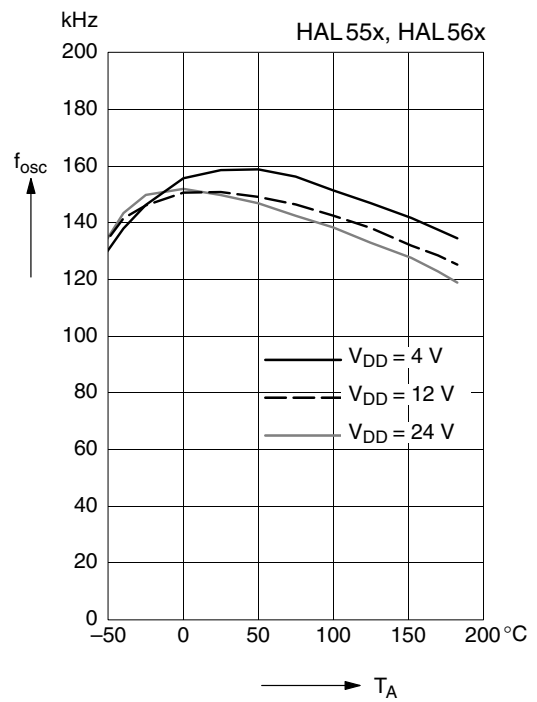
**Fig. 3-4:** Typical current consumption versus supply voltage



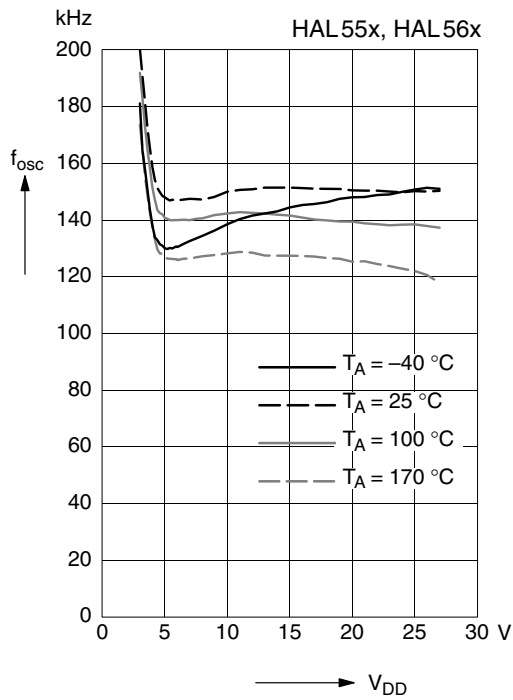
**Fig. 3-6:** Typical current consumption versus ambient temperature



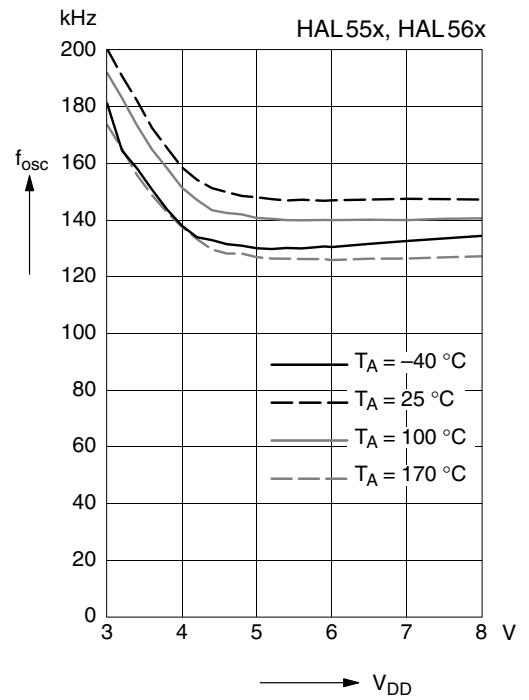
**Fig. 3-5:** Typical current consumption versus supply voltage



**Fig. 3-7:** Typ. internal chopper frequency versus ambient temperature



**Fig. 3–8:** Typ. internal chopper frequency versus supply voltage



**Fig. 3–9:** Typ. internal chopper frequency versus supply voltage

## 4. Type Description

### 4.1. HAL556

The HAL556 is a very sensitive unipolar switching sensor (see Fig. 4–1).

The sensor turns to high current consumption with the magnetic south pole on the branded side of the package and turns to low current consumption if the magnetic field is removed. It does not respond to the magnetic north pole on the branded side.

For correct functioning in the application, the sensor requires only the magnetic south pole on the branded side of the package.

In the HAL55x, HAL56x two-wire sensor family, the HAL566 is a sensor with the same magnetic characteristics but with an inverted output characteristic.

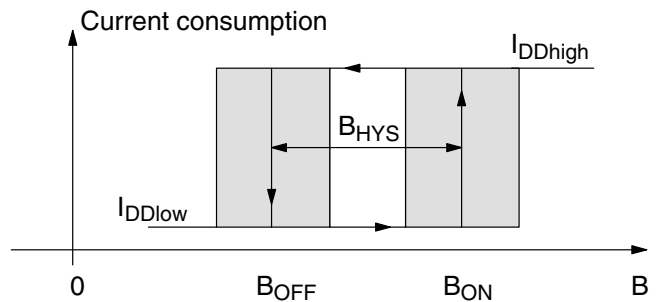
#### Magnetic Features:

- switching type: unipolar
- very high sensitivity
- typical  $B_{ON}$ : 6 mT at room temperature
- typical  $B_{OFF}$ : 4 mT at room temperature
- operates with static magnetic fields and dynamic magnetic fields up to 10 kHz

## Applications

The HAL556 is designed for applications with one magnetic polarity and weak magnetic amplitudes at the sensor position such as:

- applications with large airgap or weak magnets,
- solid state switches,
- contactless solutions to replace micro switches,
- position and end point detection, and
- rotating speed measurement.



**Fig. 4–1:** Definition of magnetic switching points for the HAL556

**Magnetic Characteristics** at  $T_J = -40\text{ °C}$  to  $+170\text{ °C}$ ,  $V_{DD} = 4\text{ V}$  to  $24\text{ V}$ ,  
Typical Characteristics for  $V_{DD} = 12\text{ V}$

Magnetic flux density values of switching points.

Positive flux density values refer to the magnetic south pole at the branded side of the package.

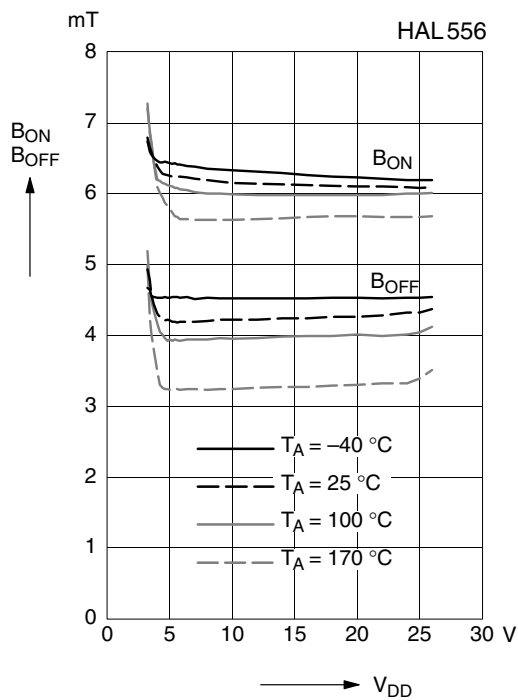
Parameter $T_J$	On point $B_{ON}$			Off point $B_{OFF}$			Hysteresis $B_{HYS}$			Magnetic Offset			Unit
	Min.	Typ.	Max.	Min.	Typ.	Max.	Min.	Typ.	Max.	Min.	Typ.	Max.	
-40 °C	3.4	6.3	7.7	2.1	4.2	5.9	0.8	2.1	3		5.2		mT
25 °C	3.4	6	7.4	2	3.8	5.7	0.5	1.8	2.8	2.7	4.9	6.5	mT
100 °C	3.2	5.5	7.2	1.9	3.7	5.7	0.3	1.8	2.8		4.6		mT
140 °C	3	5.2	7.4	1.2	3.6	6	0.2	1.6	3		4.4		mT
170 °C	2.8	5	7.6	1	3.5	6.2	0.2	1.5	3.2		4.2		mT

The hysteresis is the difference between the switching points  $B_{HYS} = B_{ON} - B_{OFF}$

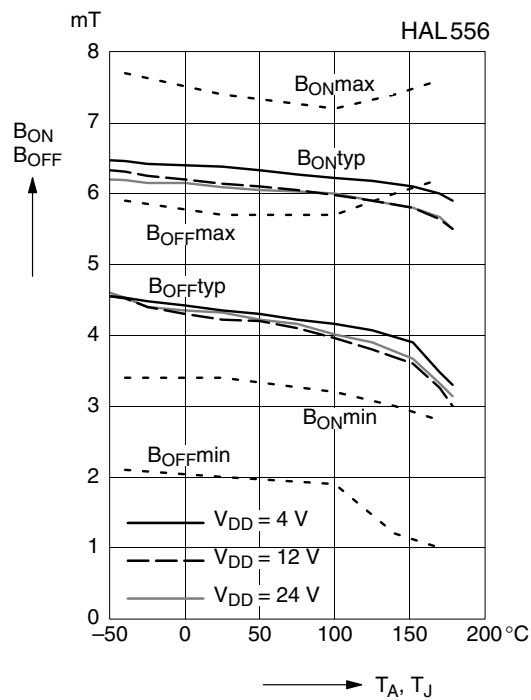
The magnetic offset is the mean value of the switching points  $B_{OFFSET} = (B_{ON} + B_{OFF}) / 2$

Changes to the previous edition:

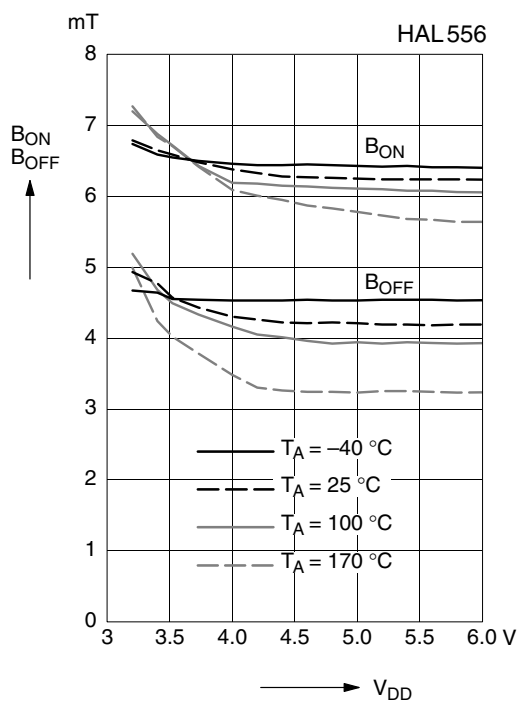
- upper limit for  $B_{HYS}$  at  $-40\text{ °C}$ ,  $25\text{ °C}$ , and  $100\text{ °C}$ ; limits for  $B_{Offset}$  at  $25\text{ °C}$  changed
- specification for  $140\text{ °C}$  and  $170\text{ °C}$  added



**Fig. 4-2:** Typ. magnetic switching points versus supply voltage



**Fig. 4-4:** Magnetic switching points versus temperature



**Fig. 4-3:** Typ. magnetic switching points versus supply voltage

**Note:** In the diagram “Magnetic switching points versus temperature” the curves for  $B_{ONmin}$ ,  $B_{ONmax}$ ,  $B_{OFFmin}$ , and  $B_{OFFmax}$  refer to junction temperature, whereas typical curves refer to ambient temperature.

## 4.2. HAL560

The HAL560 is a low sensitive unipolar switching sensor with an inverted output (see Fig. 4–5).

The sensor turns to low current consumption with the magnetic south pole on the branded side of the package and turns to high current consumption if the magnetic field is removed. It does not respond to the magnetic north pole on the branded side.

For correct functioning in the application, the sensor requires only the magnetic south pole on the branded side of the package.

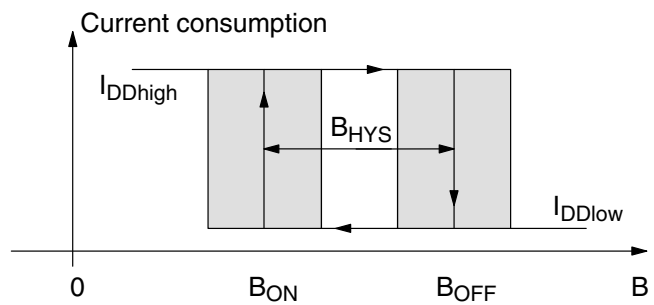
### Magnetic Features:

- switching type: unipolar inverted
- low sensitivity
- typical  $B_{ON}$ : 45.6 mT at room temperature
- typical  $B_{OFF}$ : 51.7 mT at room temperature
- operates with static magnetic fields and dynamic magnetic fields up to 10 kHz

## Applications

The HAL560 is designed for applications with one magnetic polarity and strong magnetic amplitudes at the sensor position where an inverted output signal is required such as:

- applications with strong magnets,
- solid state switches,
- contactless solutions to replace micro switches,
- position and end point detection, and
- rotating speed measurement.



**Fig. 4–5:** Definition of magnetic switching points for the HAL560

### Magnetic Characteristics at $T_J = -40\text{ °C}$ to $+170\text{ °C}$ , $V_{DD} = 4\text{ V}$ to $24\text{ V}$ , Typical Characteristics for $V_{DD} = 12\text{ V}$

Magnetic flux density values of switching points.

Positive flux density values refer to the magnetic south pole at the branded side of the package.

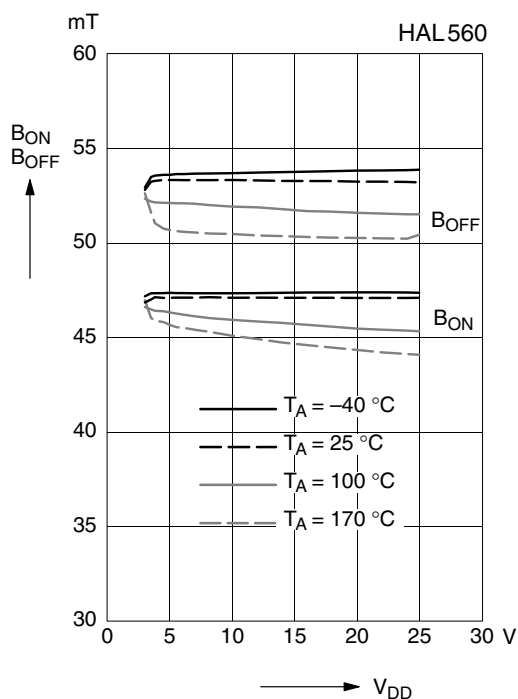
Parameter $T_J$	On point $B_{ON}$			Off point $B_{OFF}$			Hysteresis $B_{HYS}$			Magnetic Offset			Unit
	Min.	Typ.	Max.	Min.	Typ.	Max.	Min.	Typ.	Max.	Min.	Typ.	Max.	
-40 °C	41	46.5	52	47	53	59	4	6.5	10		49.8		mT
25 °C	41	46.5	52	46	52.5	58.5	3	6	9		49.5		mT
100 °C	41	45.7	52	45	51.1	57.5	2	5.4	8		48.4		mT
140 °C	39	44.8	51	43.5	49.8	56.5	2	5	8		47.3		mT
170 °C	38	44.2	50	42	49	55.5	2	4.8	8		46.6		mT

The hysteresis is the difference between the switching points  $B_{HYS} = B_{OFF} - B_{ON}$

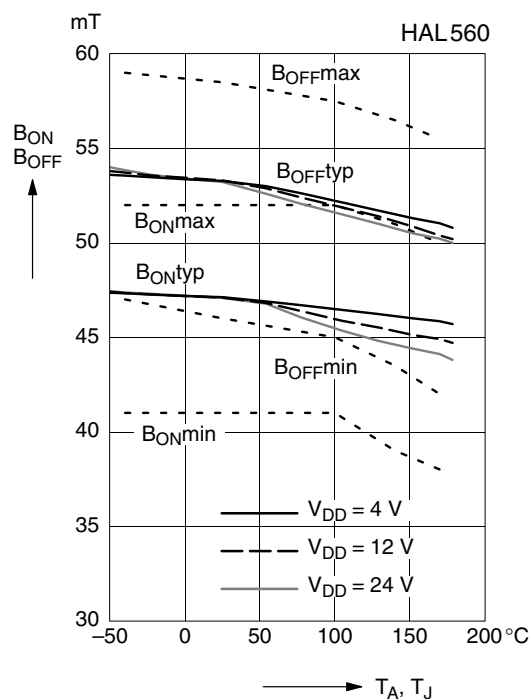
The magnetic offset is the mean value of the switching points  $B_{OFFSET} = (B_{ON} + B_{OFF}) / 2$

Changes to the previous edition:

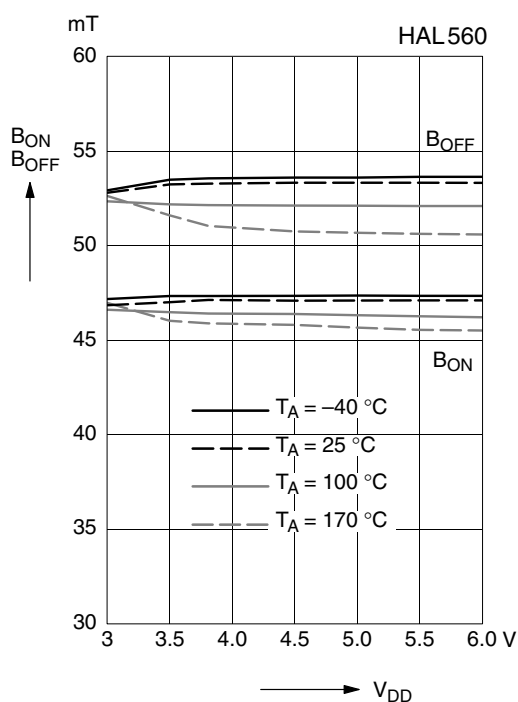
- tighter specification for  $B_{OFF}$  at  $-40\text{ °C}$ ,  $25\text{ °C}$ , and  $100\text{ °C}$
- specification for  $140\text{ °C}$  and  $170\text{ °C}$  added



**Fig. 4-6:** Typ. magnetic switching points versus supply voltage



**Fig. 4-8:** Magnetic switching points versus temperature



**Fig. 4-7:** Typ. magnetic switching points versus supply voltage

**Note:** In the diagram “Magnetic switching points versus temperature” the curves for  $B_{ONmin}$ ,  $B_{ONmax}$ ,  $B_{OFFmin}$ , and  $B_{OFFmax}$  refer to junction temperature, whereas typical curves refer to ambient temperature.

## 4.3. HAL566

The HAL566 is a very sensitive unipolar switching sensor with an inverted output (see Fig. 4–9).

The sensor turns to low current consumption with the magnetic south pole on the branded side of the package and turns to high current consumption if the magnetic field is removed. It does not respond to the magnetic north pole on the branded side.

For correct functioning in the application, the sensor requires only the magnetic south pole on the branded side of the package.

In the HAL55x, HAL56x two-wire sensor family, the HAL566 is a sensor with the same magnetic characteristics but with a normal output characteristic.

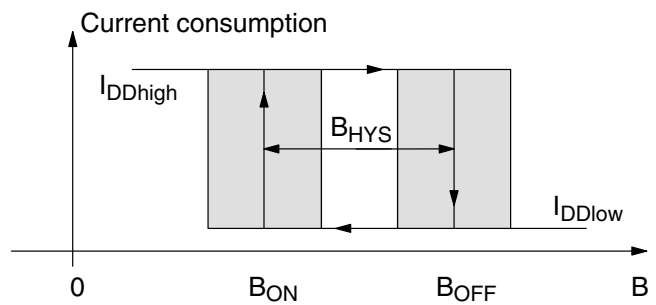
### Magnetic Features:

- switching type: unipolar inverted
- high sensitivity
- typical  $B_{ON}$ : 4 mT at room temperature
- typical  $B_{OFF}$ : 5.9 mT at room temperature
- operates with static magnetic fields and dynamic magnetic fields up to 10 kHz

## Applications

The HAL566 is designed for applications with one magnetic polarity and weak magnetic amplitudes at the sensor position where an inverted output signal is required such as:

- applications with large airgap or weak magnets,
- solid state switches,
- contactless solutions to replace micro switches,
- position and end point detection, and
- rotating speed measurement.



**Fig. 4–9:** Definition of magnetic switching points for the HAL566

**Magnetic Characteristics** at  $T_J = -40\text{ °C}$  to  $+170\text{ °C}$ ,  $V_{DD} = 4\text{ V}$  to  $24\text{ V}$ ,  
Typical Characteristics for  $V_{DD} = 12\text{ V}$

Magnetic flux density values of switching points.

Positive flux density values refer to the magnetic south pole at the branded side of the package.

Parameter $T_J$	On point $B_{ON}$			Off point $B_{OFF}$			Hysteresis $B_{HYS}$			Magnetic Offset			Unit
	Min.	Typ.	Max.	Min.	Typ.	Max.	Min.	Typ.	Max.	Min.	Typ.	Max.	
$-40\text{ °C}$	2.1	4	5.9	3.4	6	7.7	0.8	2	2.8		5		mT
$25\text{ °C}$	2	3.9	5.7	3.4	5.9	7.2	0.5	2	2.7	3	4.9	6.2	mT
$100\text{ °C}$	1.85	3.8	5.7	3.25	5.6	7	0.3	1.8	2.6		4.7		mT
$140\text{ °C}$	1.3	3.6	6	2.6	5.2	7.3	0.2	1.6	3		4.4		mT
$170\text{ °C}$	1	3.4	6.3	2.2	4.8	7.6	0.2	1.4	3		4.1		mT

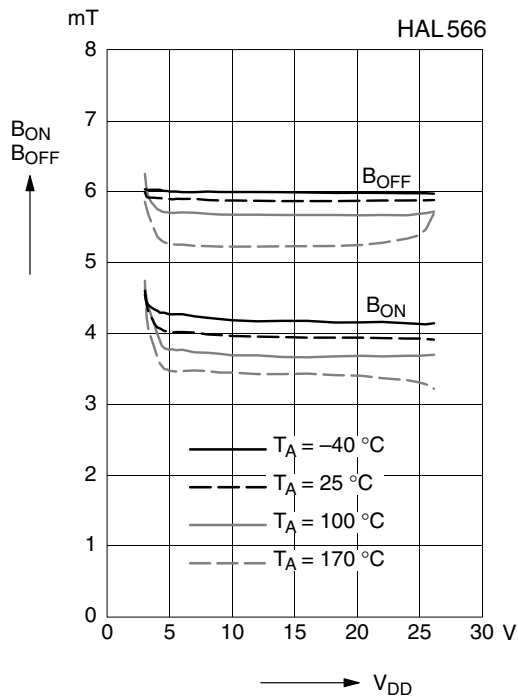
The hysteresis is the difference between the switching points  $B_{HYS} = B_{OFF} - B_{ON}$

The magnetic offset is the mean value of the switching points  $B_{OFFSET} = (B_{ON} + B_{OFF}) / 2$

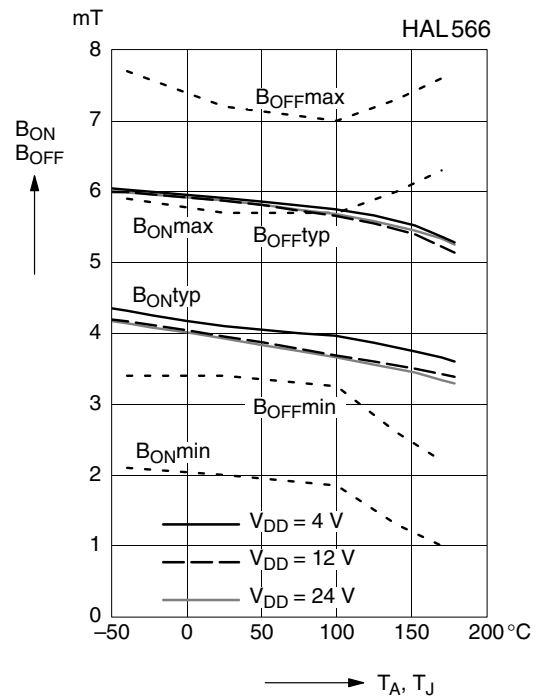
Changes to the previous edition:

- specification for  $140\text{ °C}$  and  $170\text{ °C}$  added

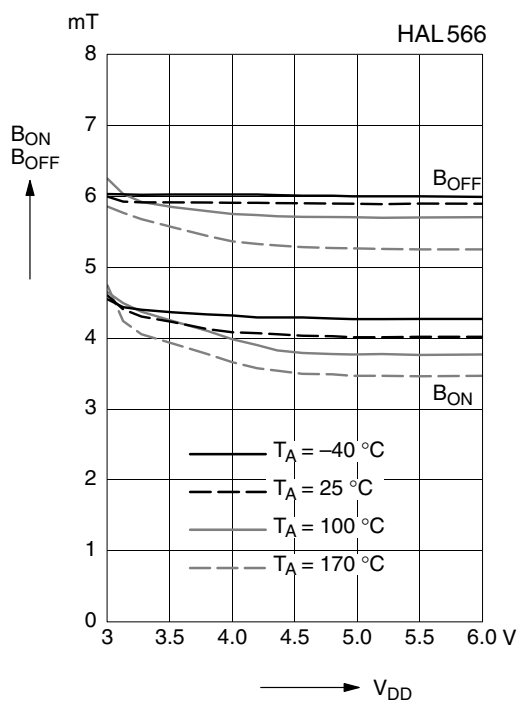




**Fig. 4-10:** Typ. magnetic switching points versus supply voltage



**Fig. 4-12:** Magnetic switching points versus temperature



**Fig. 4-11:** Typ. magnetic switching points versus supply voltage

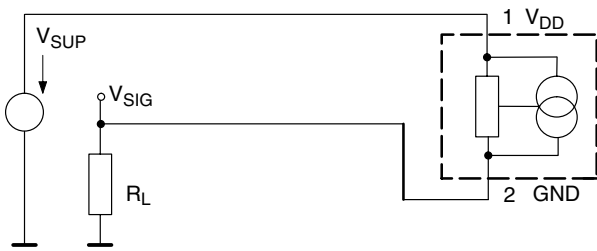
**Note:** In the diagram “Magnetic switching points versus temperature” the curves for  $B_{ONmin}$ ,  $B_{ONmax}$ ,  $B_{OFFmin}$ , and  $B_{OFFmax}$  refer to junction temperature, whereas typical curves refer to ambient temperature.

## 5. Application Notes

### 5.1. Application Circuit

Figure 5–1 shows a simple application with a two-wire sensor. The current consumption can be detected by measuring the voltage over  $R_L$ . For correct functioning of the sensor, the voltage between pin 1 and 2 ( $V_{DD}$ ) must be a minimum of 4 V. With the maximum current consumption of 17 mA, the maximum  $R_L$  can be calculated as:

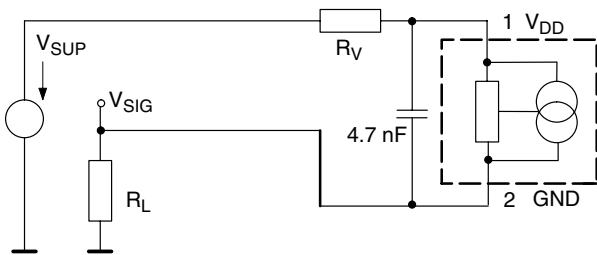
$$R_{Lmax} = \frac{V_{SUPmin} - 4V}{17 \text{ mA}}$$



**Fig. 5–1:** Application Circuit 1

For applications with disturbances on the supply line or radiated disturbances, a series resistor  $R_V$  (ranging from 10  $\Omega$  to 30  $\Omega$ ) and a capacitor both placed close to the sensor are recommended (see figure 5–2). In this case, the maximum  $R_L$  can be calculated as:

$$R_{Lmax} = \frac{V_{SUPmin} - 4V}{17 \text{ mA}} - R_V$$



**Fig. 5–2:** Application Circuit 2

### 5.2. Extended Operating Conditions

All sensors fulfill the electrical and magnetic characteristics when operated within the Recommended Operating Conditions (see page 7).

Typically, the sensors operate with supply voltages above 3 V. However, below 4 V, the current consumption and the magnetic characteristics may be outside the specification.

**Note:** The functionality of the sensor below 4 V is not tested on a regular base. For special test conditions, please contact Micronas.

### 5.3. Start-up Behavior

Due to the active offset compensation, the sensors have an initialization time (enable time  $t_{en(O)}$ ) after applying the supply voltage. The parameter  $t_{en(O)}$  is specified in the Electrical Characteristics (see page 8). During the initialization time, the current consumption is not defined and can toggle between low and high.

#### HAL 556:

After  $t_{en(O)}$ , the current consumption will be high if the applied magnetic field  $B$  is above  $B_{ON}$ . The current consumption will be low if  $B$  is below  $B_{OFF}$ .

#### HAL 560, HAL 566:

In case of sensors with an inverted switching behavior, the current consumption will be low if  $B > B_{OFF}$  and high if  $B < B_{ON}$ .

**Note:** For magnetic fields between  $B_{OFF}$  and  $B_{ON}$ , the current consumption of the HAL sensor will be either low or high after applying  $V_{DD}$ . In order to achieve a defined current consumption, the applied magnetic field must be above  $B_{ON}$ , respectively, below  $B_{OFF}$ .

## 5.4. Ambient Temperature

Due to internal power dissipation, the temperature on the silicon chip (junction temperature  $T_J$ ) is higher than the temperature outside the package (ambient temperature  $T_A$ ).

$$T_J = T_A + \Delta T$$

At static conditions and continuous operation, the following equation is valid:

$$\Delta T = I_{DD} * V_{DD} * R_{th}$$

For all sensors, the junction temperature range  $T_J$  is specified. The maximum ambient temperature  $T_{Amax}$  can be calculated as:

$$T_{Amax} = T_{Jmax} - \Delta T$$

For typical values, use the typical parameters. For worst case calculation, use the max. parameters for  $I_{DD}$  and  $R_{th}$ , and the max. value for  $V_{DD}$  from the application.

Due to the range of  $I_{DDhigh}$ , self-heating can be critical. The junction temperature can be reduced with pulsed supply voltage. For supply times ( $t_{on}$ ) ranging from 30  $\mu$ s to 1 ms, the following equation can be used:

$$\Delta T = I_{DD} * V_{DD} * R_{th} * \frac{t_{on}}{t_{off} + t_{on}}$$

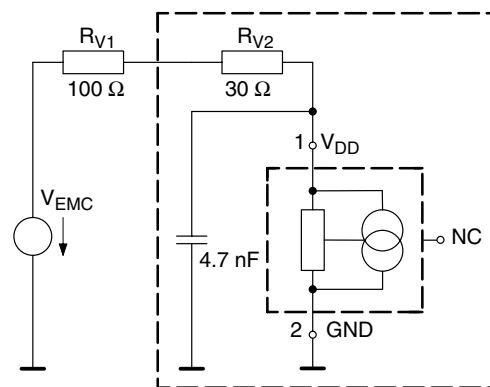
## 5.5. EMC and ESD

For applications with disturbances on the supply line or radiated disturbances, a series resistor and a capacitor are recommended (see Fig. 5–2). The series resistor and the capacitor should be placed as closely as possible to the HAL sensor.

Applications with this arrangement passed the EMC tests according to the product standards DIN 40839.

**Note:** The international standard ISO 7637 is similar to the product standard DIN 40839.

Please contact Micronas for the detailed investigation reports with the EMC and ESD results.



**Fig. 5–3:** Recommended EMC test circuit

## 6. Data Sheet History

1. Final data sheet: "HAL556, HAL560, HAL566, Two-Wire Hall Effect Sensor Family, April 6, 1999, 6251-425-1DS. First release of the final data sheet.
2. Final data sheet: "HAL556, HAL560, HAL566, Two-Wire Hall Effect Sensor Family, Aug. 3, 2000, 6251-425-2DS. Second release of the final data sheet. Major changes:
  - magnetic characteristics for HAL556 and HAL560 changed. Please refer to pages 12 and 14 for details.
  - new temperature ranges "K" and "A" added
  - temperature range "C" removed
  - outline dimensions for SOT-89B: reduced tolerances
  - SMD package SOT-89A removed

Micronas GmbH  
Hans-Bunte-Strasse 19  
D-79108 Freiburg (Germany)  
P.O. Box 840  
D-79008 Freiburg (Germany)  
Tel. +49-761-517-0  
Fax +49-761-517-2174  
E-mail: docservice@micronas.com  
Internet: www.micronas.com

Printed in Germany  
by Systemdruck+Verlags-GmbH, Freiburg (08/2000)  
Order No. 6251-425-2DS

All information and data contained in this data sheet are without any commitment, are not to be considered as an offer for conclusion of a contract, nor shall they be construed as to create any liability. Any new issue of this data sheet invalidates previous issues. Product availability and delivery are exclusively subject to our respective order confirmation form; the same applies to orders based on development samples delivered. By this publication, Micronas GmbH does not assume responsibility for patent infringements or other rights of third parties which may result from its use.

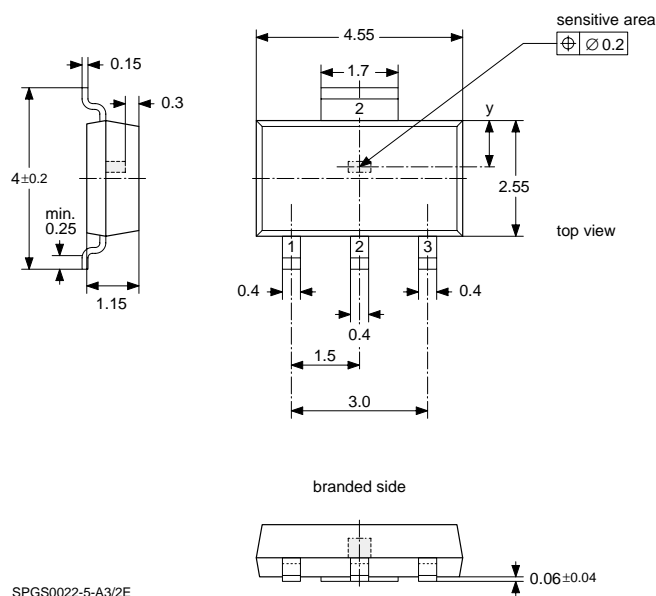
Further, Micronas GmbH reserves the right to revise this publication and to make changes to its content, at any time, without obligation to notify any person or entity of such revisions or changes.

No part of this publication may be reproduced, photocopied, stored on a retrieval system, or transmitted without the express written consent of Micronas GmbH.

<b>Subject:</b>	Improvement of SOT-89B Package
<b>Data Sheet Concerned:</b>	HAL 114, 115, 6251-456-2DS, Dec. 20, 1999 HAL 50x, 51x, 6251-485-1DS, Feb. 16, 1999 HAL 55x, 56x, 6251-425-1DS, April 6, 1999 HAL 621, 629, 6251-504-1DS, Feb. 3, 2000
<b>Supplement:</b>	No. 1/ 6251-531-1DSS
<b>Edition:</b>	July 4, 2000

### Changes:

- position tolerance of the sensitive area reduced
- tolerances of the outline dimensions reduced
- thickness of the leadframe changed to 0.15 mm (old 0.125 mm)
- SOT-89A will be discontinued in December 2000



### Position of sensitive area

	HAL 114, 115 HAL 50x, 51x HAL 621, 629	HAL 55x, HAL 56x
x	center of the package	center of the package
y	0.95 mm nominal	0.85 mm nominal

**Note:** A mechanical tolerance of  $\pm 0.05$  mm applies to all dimensions where no tolerance is explicitly given. Position tolerance of the sensitive area is defined in the package diagram.