

## 250V N-CHANNEL ENHANCEMENT MODE MOSFET

### SUMMARY

$V_{(BR)DSS}=250V$ ;  $R_{DS(ON)}=8.5\Omega$ ;  $I_D=310mA$

### DESCRIPTION

This 250V enhancement mode N-channel MOSFET provides users with a competitive specification offering efficient power handling capability, high impedance and is free from thermal runaway and thermally induced secondary breakdown. Applications benefiting from this device include a variety of Telecom and general high voltage circuits.

SOT89 and SOT23-6 versions are also available.

### FEATURES

- High voltage
- Low on-resistance
- Fast switching speed
- Low gate drive
- Low threshold
- Complementary P-channel Type ZVP4525G
- SOT223 package

### APPLICATIONS

- Earth Recall and dialling switches
- Electronic hook switches
- High Voltage Power MOSFET Drivers
- Telecom call routers
- Solid state relays

### ORDERING INFORMATION

DEVICE	REEL SIZE (inches)	TAPE WIDTH (mm)	QUANTITY PER REEL
ZVN4525GTA	7	8mm embossed	1000 units
ZVN4525GTC	13	8mm embossed	4000 units

### DEVICE MARKING

- ZVN4525G

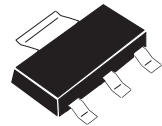

**SOT223**

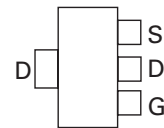
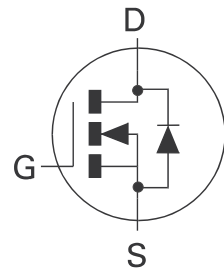

Top View

# ZVN4525G

## ABSOLUTE MAXIMUM RATINGS.

PARAMETER	SYMBOL	LIMIT	UNIT
Drain-Source Voltage	$V_{DSS}$	250	V
Gate Source Voltage	$V_{GS}$	$\pm 40$	V
Continuous Drain Current ( $V_{GS}=10V$ ; $T_A=25^\circ C$ )(a) ( $V_{GS}=10V$ ; $T_A=70^\circ C$ )(a)	$I_D$	310	mA
	$I_D$	248	mA
Pulsed Drain Current (c)	$I_{DM}$	1.44	A
Continuous Source Current (Body Diode)	$I_S$	1.1	A
Pulsed Source Current (Body Diode)	$I_{SM}$	1.44	A
Power Dissipation at $T_A=25^\circ C$ (a) Linear Derating Factor	$P_D$	2	W
		16	mW/ $^\circ C$
Operating and Storage Temperature Range	$T_j; T_{stg}$	-55 to +150	$^\circ C$

## THERMAL RESISTANCE

PARAMETER	SYMBOL	VALUE	UNIT
Junction to Ambient (a)	$R_{\theta JA}$	63	$^\circ C/W$
Junction to Ambient (b)	$R_{\theta JA}$	26	$^\circ C/W$

### NOTES

(a) For a device surface mounted on 25mm x 25mm FR4 PCB with high coverage of single sided 1oz copper, in still air conditions

(b) For a device surface mounted on FR4 PCB measured at  $t \leq 5$  secs.

(c) Repetitive rating - pulse width limited by maximum junction temperature. Refer to Transient Thermal

### NB High Voltage Applications

For high voltage applications, the appropriate industry sector guidelines should be considered with regard to voltage spacing between conductors.

## CHARACTERISTICS

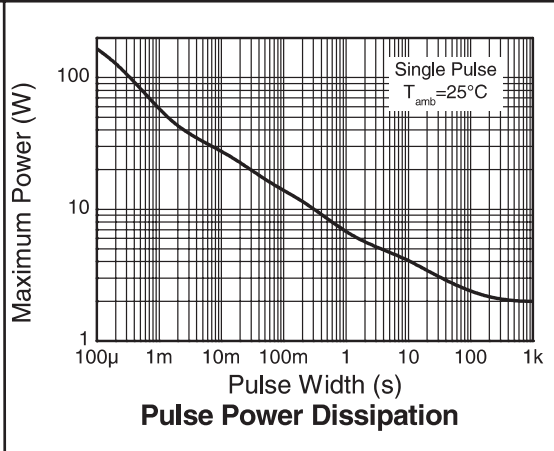
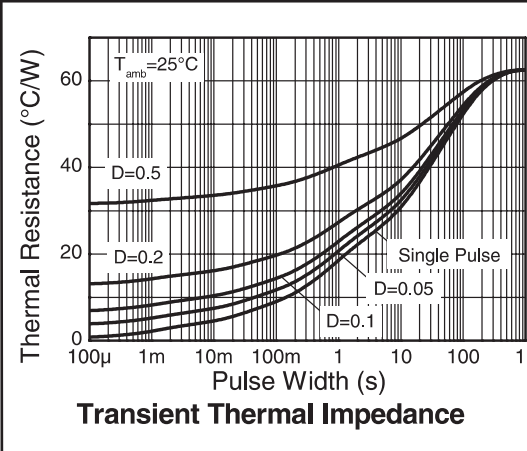
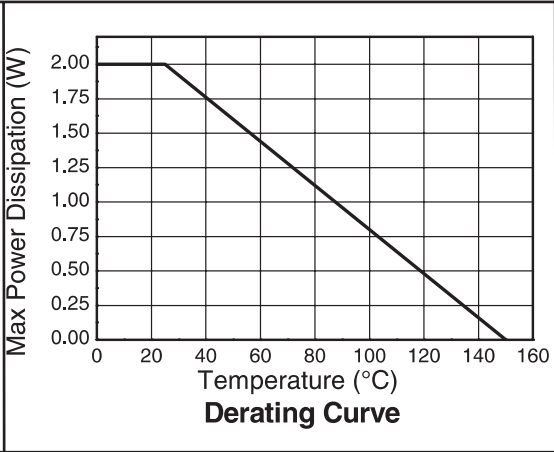
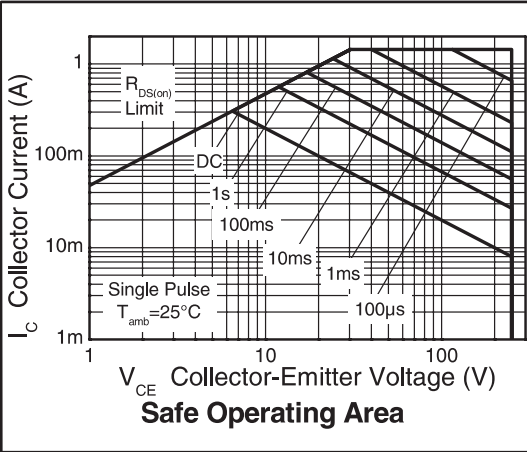

# ZVN4525G

## ELECTRICAL CHARACTERISTICS (at $T_{amb} = 25^{\circ}\text{C}$ unless otherwise stated).

PARAMETER	SYMBOL	MIN.	TYP.	MAX.	UNI T	CONDITIONS.
<b>STATIC</b>						
Drain-Source Breakdown Voltage	$V_{(BR)DSS}$	250	285		V	$I_D=1\text{mA}, V_{GS}=0\text{V}$
Zero Gate Voltage Drain Current	$I_{DSS}$		35	500	nA	$V_{DS}=250\text{V}, V_{GS}=0\text{V}$
Gate-Body Leakage	$I_{GSS}$		$\pm 1$	$\pm 100$	nA	$V_{GS}=\pm 40\text{V}, V_{DS}=0\text{V}$
Gate-Source Threshold Voltage	$V_{GS(th)}$	0.8	1.4	1.8	V	$I_D=1\text{mA}, V_{DS}=V_{GS}$
Static Drain-Source On-State Resistance (1)	$R_{DS(on)}$		5.6 5.9 6.4	8.5 9.0 9.5	$\Omega$	$V_{GS}=10\text{V}, I_D=500\text{mA}$ $V_{GS}=4.5\text{V}, I_D=360\text{mA}$ $V_{GS}=2.4\text{V}, I_D=20\text{mA}$
Forward Transconductance (3)	$g_{fs}$	0.3	0.475		S	$V_{DS}=10\text{V}, I_D=0.3\text{A}$
<b>DYNAMIC (3)</b>						
Input Capacitance	$C_{iss}$		72		pF	$V_{DS}=25\text{V}, V_{GS}=0\text{V},$ $f=1\text{MHz}$
Output Capacitance	$C_{oss}$		11		pF	
Reverse Transfer Capacitance	$C_{rss}$		3.6		pF	
<b>SWITCHING(2) (3)</b>						
Turn-On Delay Time	$t_{d(on)}$		1.25		ns	$V_{DD}=30\text{V}, I_D=360\text{mA}$ $R_G=50\Omega, V_{GS}=10\text{V}$ (refer to test circuit)
Rise Time	$t_r$		1.70		ns	
Turn-Off Delay Time	$t_{d(off)}$		11.40		ns	
Fall Time	$t_f$		3.50		ns	
Total Gate Charge	$Q_g$		2.6	3.65	nC	$V_{DS}=25\text{V}, V_{GS}=10\text{V},$ $I_D=360\text{mA}$ (refer to test circuit)
Gate-Source Charge	$Q_{gs}$		0.2	0.28	nC	
Gate Drain Charge	$Q_{gd}$		0.5	0.70	nC	
<b>SOURCE-DRAIN DIODE</b>						
Diode Forward Voltage (1)	$V_{SD}$			0.97	V	$T_j=25^{\circ}\text{C}, I_S=360\text{mA},$ $V_{GS}=0\text{V}$
Reverse Recovery Time (3)	$t_{rr}$		186	260	ns	$T_j=25^{\circ}\text{C}, I_F=360\text{mA},$ $di/dt= 100\text{A}/\mu\text{s}$
Reverse Recovery Charge (3)	$Q_{rr}$		34	48	nC	

(1) Measured under pulsed conditions. Width=300 $\mu\text{s}$ . Duty cycle  $\leq 2\%$  .

(2) Switching characteristics are independent of operating junction temperature.

(3) For design aid only, not subject to production testing.

TYPICAL CHARACTERISTICS

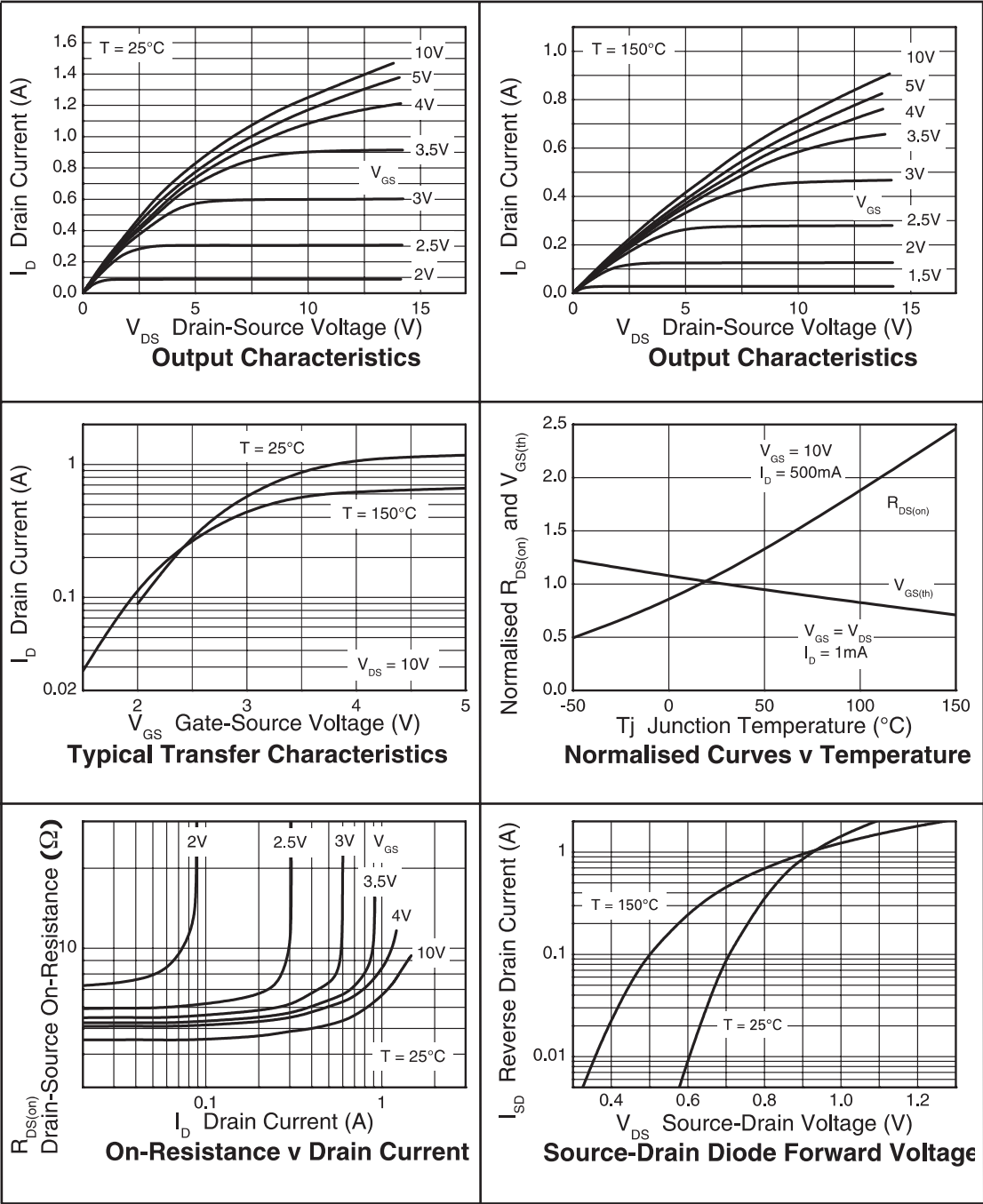

# ZVN4525G

## CHARACTERISTICS

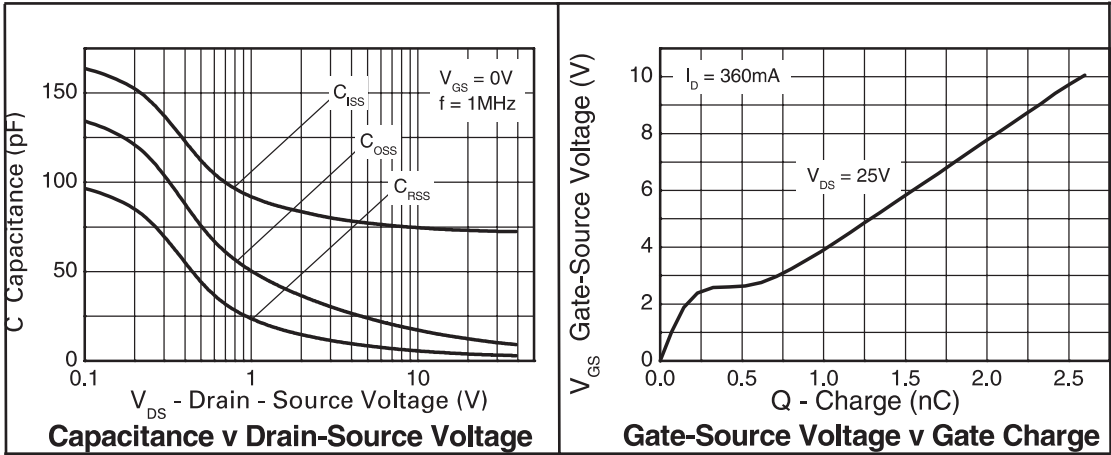

CHARACTERISTICS

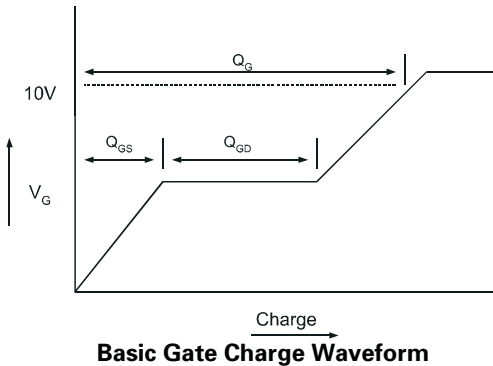

Basic Gate Charge Waveform

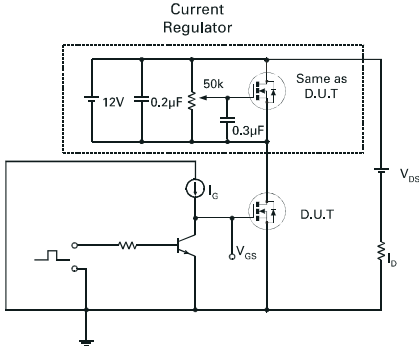

Gate Charge Test Circuit

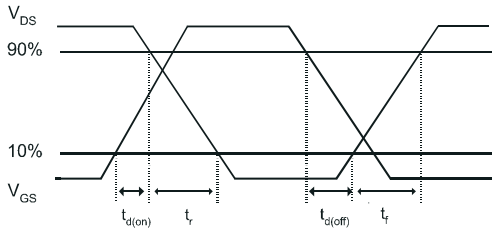

Switching Time Waveforms

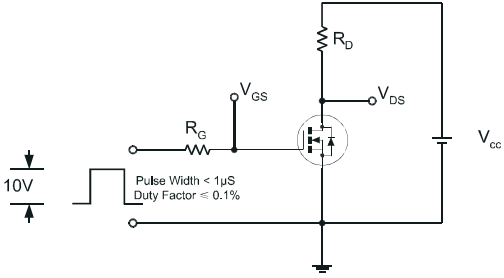

Switching Time Test Circuit

# ZVN4525G

## PACKAGE DIMENSIONS

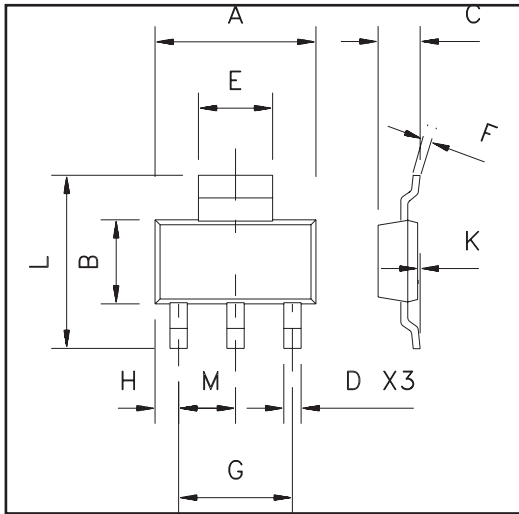

## PAD LAYOUT DETAILS

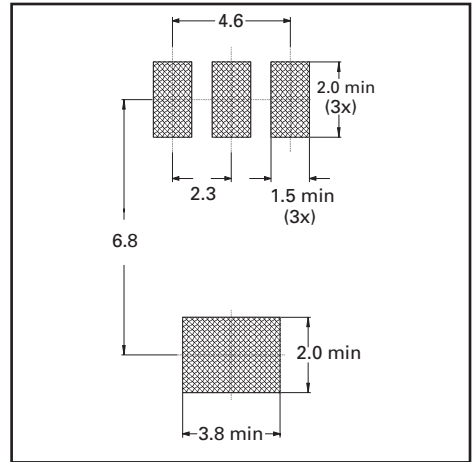

Dim	Millimeters		Inches	
	Min	Max	Min	Max
A	6.3	6.7	0.248	0.264
B	3.3	3.7	0.130	0.146
C	-	1.7	-	0.067
D	0.6	0.8	0.024	0.031
E	2.9	3.1	0.114	0.122
F	0.24	0.32	0.009	0.013
G	NOM 4.6		NOM 0.181	
H	0.85	1.05	0.033	0.041
K	0.02	0.10	0.0008	0.004
L	6.7	7.3	0.264	0.287
M	NOM 2.3		NOM 0.0905	



Zetex plc.  
Fields New Road, Chadderton, Oldham, OL9-8NP, United Kingdom.  
Telephone: (44)161 622 4422 (Sales), (44)161 622 4444 (General Enquiries)  
Fax: (44)161 622 4420

Zetex GmbH  
Streitfeldstraße 19  
D-81673 München  
Germany  
Telephone: (49) 89 45 49 49 0  
Fax: (49) 89 45 49 49 49

Zetex Inc.  
47 Mall Drive, Unit 4  
Commack NY 11725  
USA  
Telephone: (631) 543-7100  
Fax: (631) 864-7630

Zetex (Asia) Ltd.  
3701-04 Metroplaza, Tower 1  
Hing Fong Road,  
Kwai Fong, Hong Kong  
Telephone: (852) 26100 611  
Fax: (852) 24250 494

These are supported by  
agents and distributors in  
major countries world-wide  
© Zetex plc 2000  
www.zetex.com

This publication is issued to provide outline information only which (unless agreed by the Company in writing) may not be used, applied or reproduced for any purpose or form part of any order or contract or be regarded as a representation relating to the products or services concerned. The Company reserves the right to alter without notice the specification, design, price or conditions of supply of any product or service.