

Hyper Mini SIDELED® Hyper-Bright LED

LS C876, LA C876
LO C876, LY C876

Besondere Merkmale

- Gehäusefarbe: weiß
- als optischer Indikator einsetzbar
- zur Hintergrundbeleuchtung, Lichtleiter- und Linseneinkopplung
- für alle SMT-Bestück- und Löttechniken geeignet
- gegurtet (8-mm-Filmgurt)

Features

- color of package: white
- for use as optical indicator
- for backlighting, optical coupling into light pipes and lenses
- suitable for all SMT assembly and soldering methods
- available taped on reel (8 mm tape)

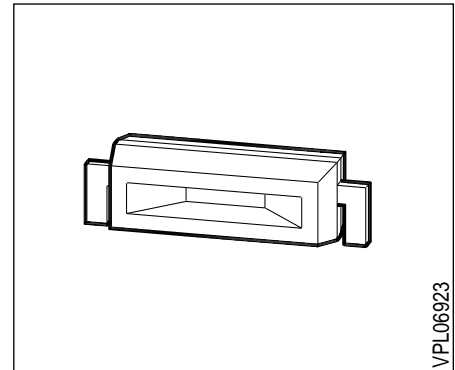

VPL06923

Typ	Emissionsfarbe	Farbe der Lichtaustrittsfläche	Lichtstärke	Lichtstrom	Bestellnummer
Type	Color of Emission	Color of the Light Emitting Area	Luminous Intensity $I_F = 20 \text{ mA}$ $I_V \text{ (mcd)}$	Luminous Flux $I_F = 20 \text{ mA}$ $\Phi_V \text{ (lm)}$	Ordering Code
LS C876-NO	super-red	colorless clear	≥ 25 (60 typ.)	180 (typ.)	Q62703-Q3659
LA C876-PO	amber	colorless clear	≥ 40 (100 typ.)	300 (typ.)	Q62703-Q3658
LO C876-PO	orange	colorless clear	≥ 40 (100 typ.)	300 (typ.)	Q62703-Q3657
LY C876-PO	yellow	colorless clear	≥ 40 (100 typ.)	300 (typ.)	Q62703-Q3656

Streuung der Lichtstärke in einer Verpackungseinheit $I_{V \max} / I_{V \min} \leq 2.0$.
Luminous intensity ratio in one packaging unit $I_{V \max} / I_{V \min} \leq 2.0$.

Grenzwerte Maximum Ratings

Bezeichnung Parameter	Symbol Symbol	Werte Values		Einheit Unit
		LS, LA, LO	LY	
Betriebstemperatur Operating temperature range	T_{op}	– 55... + 100		°C
Lagertemperatur Storage temperature range	T_{stg}	– 55... + 100		°C
Sperrschichttemperatur Junction temperature	T_j	+ 100		°C
Durchlaßstrom Forward current	I_F	30	20	mA
Stoßstrom Surge current $t \leq 10 \mu s, D = 0.005$	I_{FM}	to be defined		A
Sperrspannung ¹⁾ ($I_F = 10 \mu A$) Reverse voltage ¹⁾	V_R	3		V
Verlustleistung Power dissipation, $T_A \leq 25 \text{ °C}$	P_{tot}	80	55	mW
Wärmewiderstand Thermal resistance Sperrschicht / Umgebung Junction / air Montage auf PC-board ^{*)} (Padgröße $\geq 16 \text{ mm}^2$) mounted on PC board ^{*)} (pad size $\geq 16 \text{ mm}^2$)	R_{thJA}	630		K/W

1) Belastung in Sperrichtung sollte vermieden werden.

1) Reverse biasing should be avoided.

*) PC-board: FR4

Kennwerte ($T_A = 25 \text{ °C}$)

Characteristics

Bezeichnung Parameter	Symbol Symbol	Werte Values				Einheit Unit
		LS	LA	LO	LY	
Wellenlänge des emittierten Lichtes (typ.) Wavelength at peak emission (typ.) $I_F = 20 \text{ mA}$	λ_{peak}	645	622	610	591	nm
Dominantwellenlänge (typ.) Dominant wavelength (typ.) $I_F = 20 \text{ mA}$	λ_{dom}	632	615	605	587	nm
Spektrale Bandbreite bei 50% $I_{\text{rel max}}$ (typ.) Spectral bandwidth at 50% $I_{\text{rel max}}$ (typ.) $I_F = 20 \text{ mA}$	$\Delta\lambda$	16	16	16	15	nm
Abstrahlwinkel bei 50% I_v (Vollwinkel) Viewing angle at 50% I_v	2ϕ	120	120	120	120	Grad deg.
Durchlaßspannung (typ.) Forward voltage (max.) $I_F = 20 \text{ mA}$	V_F V_F	2.0 2.6	2.0 2.6	2.0 2.6	2.0 2.6	V V
Sperrstrom (typ.) Reverse current (max.) $V_R = 3 \text{ V}$	I_R I_R	0.01 10	0.01 10	0.01 10	0.01 10	μA μA
Temperaturkoeffizient von λ_{dom} ($I_F = 20 \text{ mA}$) Temperature coefficient of λ_{dom} ($I_F = 20 \text{ mA}$)	TC_λ	0.014	0.062	0.067	0.096	nm/K
Temperaturkoeffizient von λ_{peak} , $I_F = 20 \text{ mA}$ (typ.) Temperature coefficient of λ_{peak} , $I_F = 20 \text{ mA}$ (typ.)	TC_λ	0.14	0.13	0.13	0.13	nm/K
Temperaturkoeffizient von V_F , $I_F = 20 \text{ mA}$ (typ.) Temperature coefficient of V_F , $I_F = 20 \text{ mA}$ (typ.)	TC_V	- 1.95	- 1.78	- 1.67	- 2.51	mV/K

Relative spektrale Emission $I_{rel} = f(\lambda)$, $T_A = 25^\circ\text{C}$, $I_F = 10\text{ mA}$

Relative spectral emission

$V(\lambda)$ = spektrale Augenempfindlichkeit

Standard eye response curve

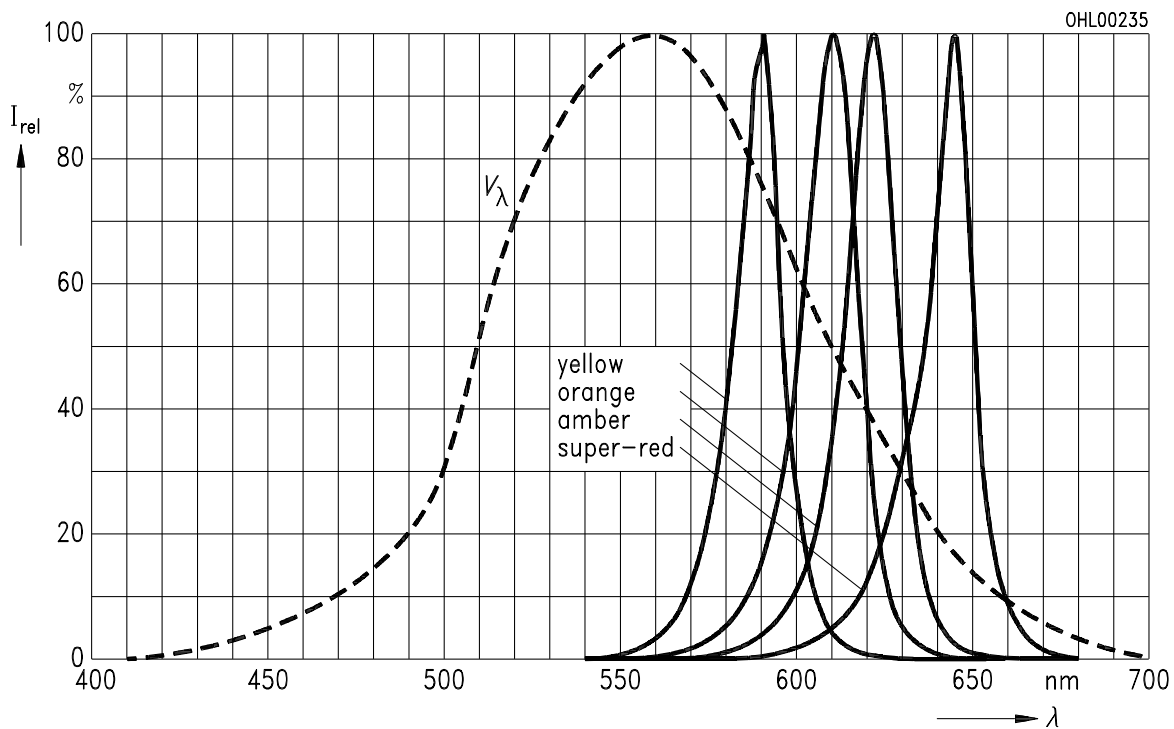

Abstrahlcharakteristik $I_{rel} = f(\varphi)$

Radiation characteristic

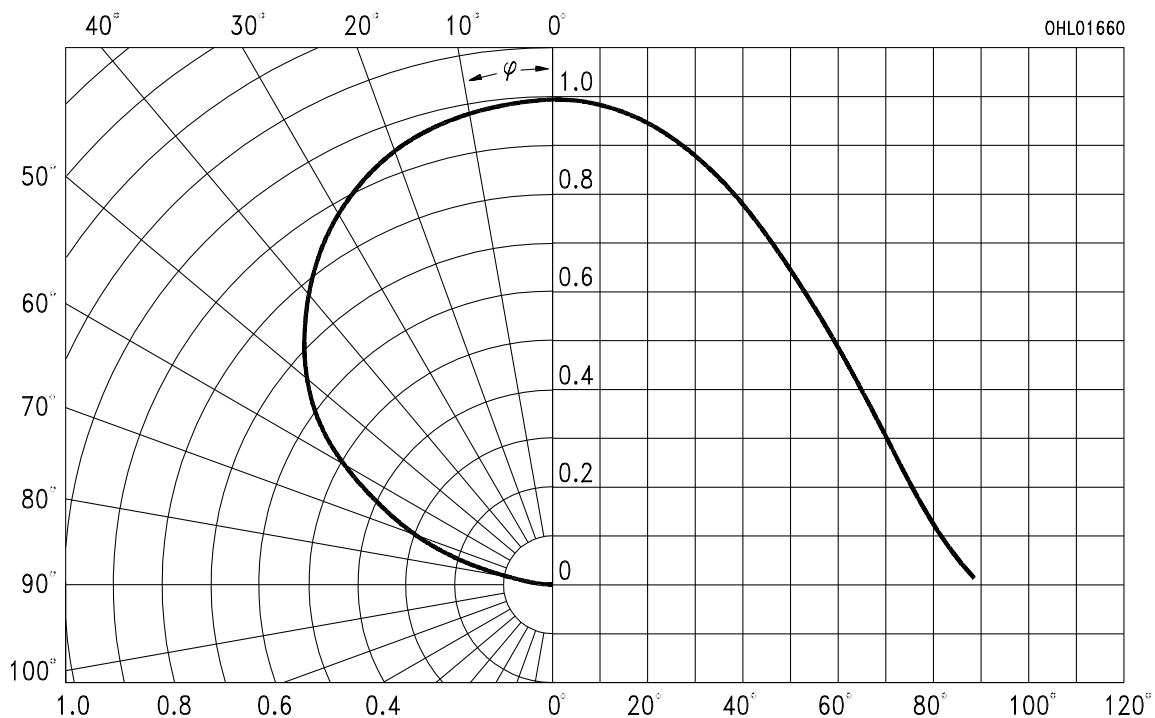

Durchlaßstrom $I_F = f(V_F)$

Forward current

$T_A = 25^\circ\text{C}$

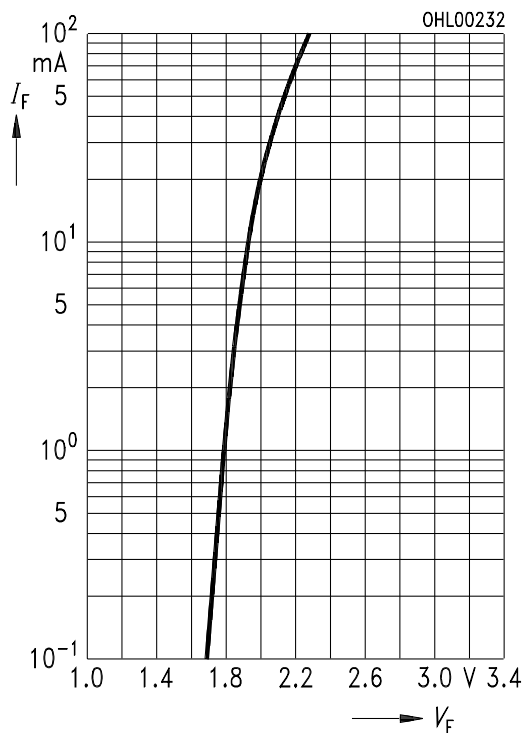

Maximal zulässiger Durchlaßstrom

Max. permissible forward current

$I_F = f(T_A)$

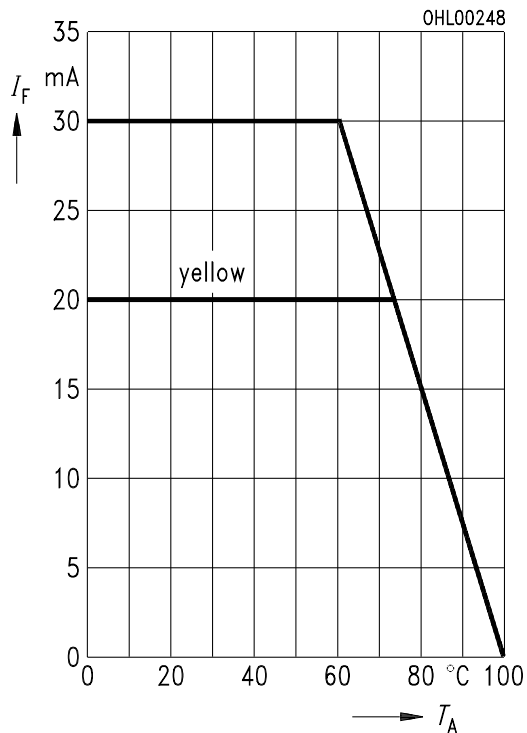

Relative Lichtstärke $I_V / I_{V(20\text{mA})} = f(I_F)$

Relative luminous intensity

$T_A = 25^\circ\text{C}$

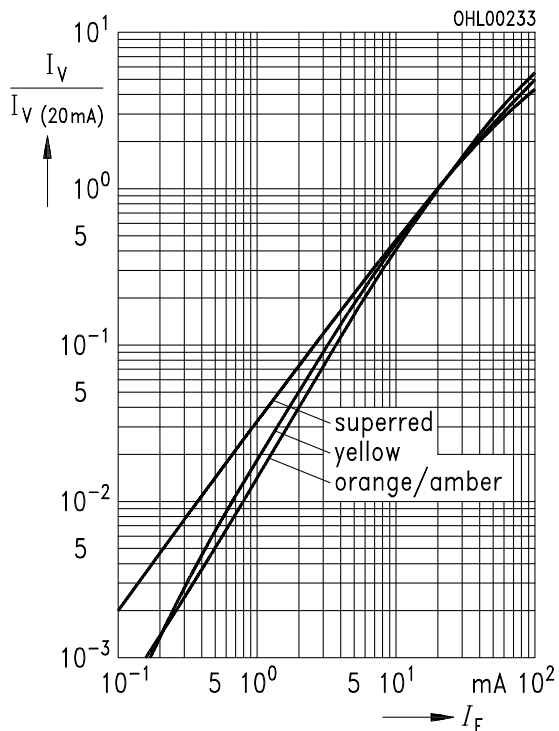

Relative Lichtstärke $I_V / I_{V(25^\circ\text{C})} = f(T_A)$

Relative luminous intensity

$I_F = 20\text{ mA}$

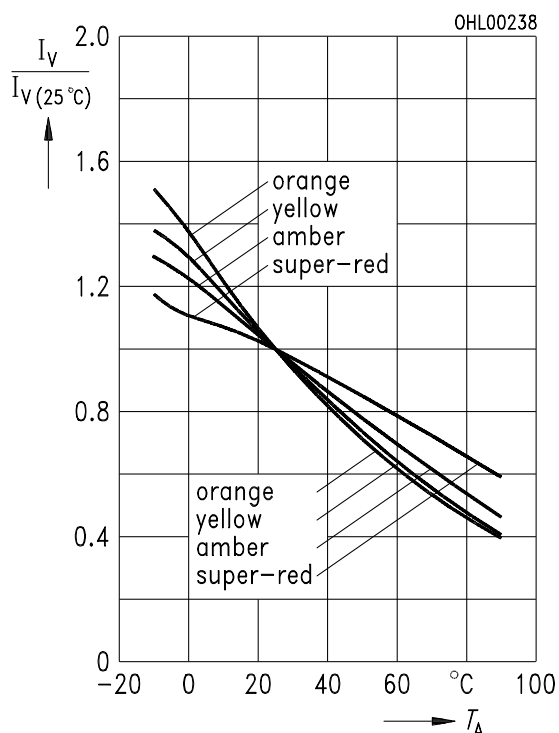

Zulässige Impulsbelastbarkeit $I_F = f(t_p)$
Permissible pulse handling capability
LS, LA, LO

Duty cycle $D =$ parameter, $T_A = 25\text{ °C}$

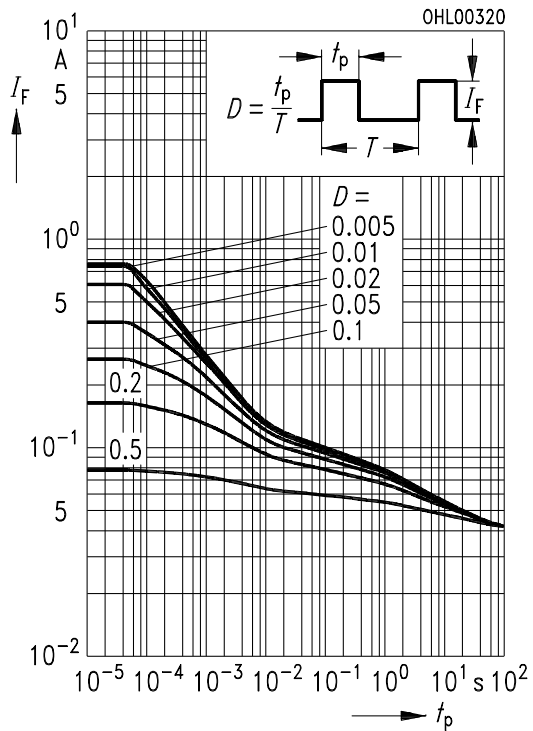

Zulässige Impulsbelastbarkeit $I_F = f(t_p)$
Permissible pulse handling capability
LY

Duty cycle $D =$ parameter, $T_A = 25\text{ °C}$

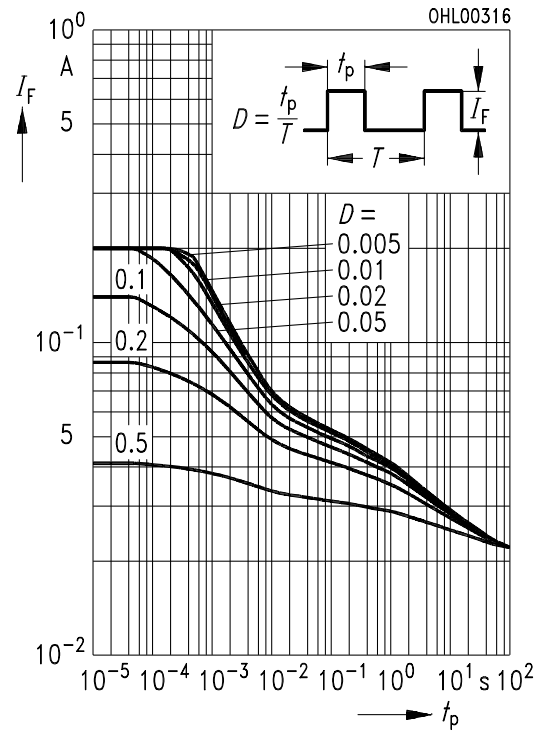

Maßzeichnung
Package Outlines

(Maße in mm, wenn nicht anders angegeben)
 (Dimensions in mm, unless otherwise specified)

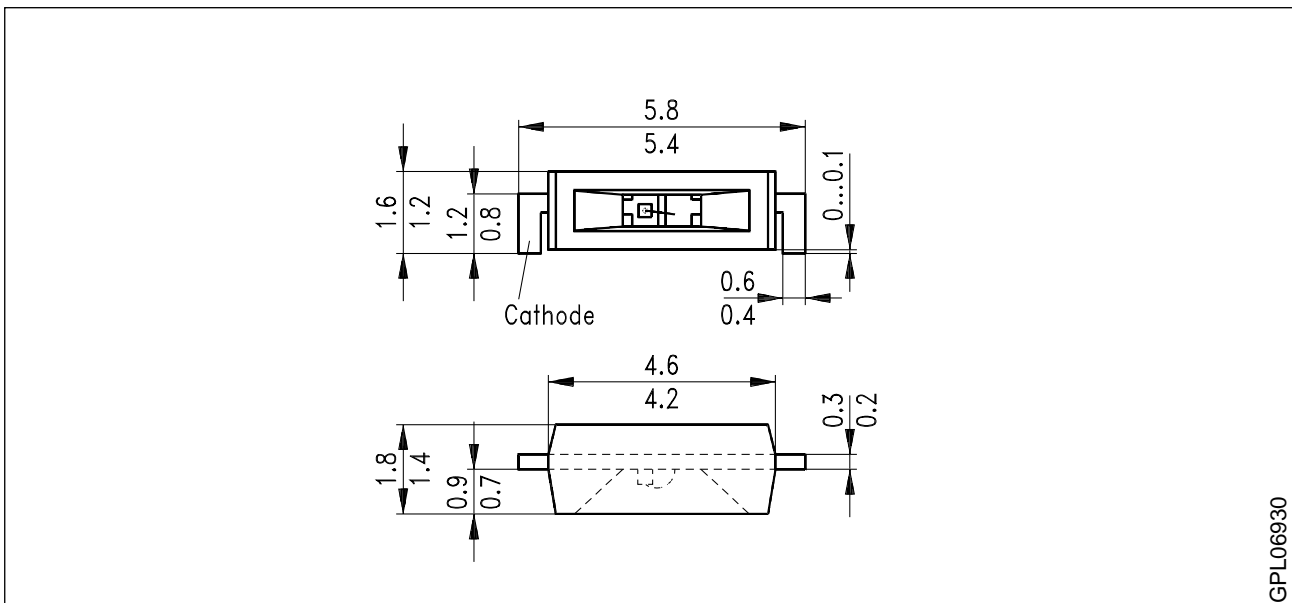

GPL06930