



# 2SA733

## PNP SILICON TRANSISTOR

### LOW FREQUENCY AMPLIFIER PNP EPITAXIAL SILICON TRANSISTOR

#### DESCRIPTION

The UTC **2SA733** is a low frequency amplifier.

#### FEATURES

- \* Collector-emitter voltage:  
BV<sub>CBO</sub>=-50V
- \* Collector current up to -150mA
- \* High h<sub>FE</sub> linearity
- \* Complimentary to 2SC945

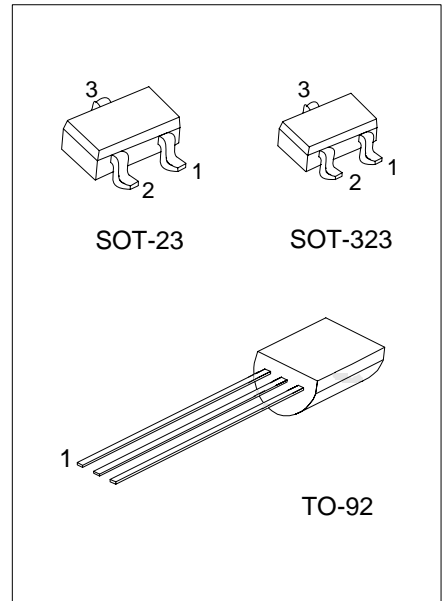

\*Pb-free plating product number:2SA733L

#### ORDERING INFORMATION

| Ordering Number |                   | Package | Pin Assignment |   |   | Packing   |
|-----------------|-------------------|---------|----------------|---|---|-----------|
| Normal          | Lead Free Plating |         | 1              | 2 | 3 |           |
| 2SA733-x-AE3-R  | 2SA733L-x-AE3-R   | SOT-23  | E              | B | C | Tape Reel |
| 2SA733-x-AL3-R  | 2SA733L-x-AL3-R   | SOT-323 | E              | B | C | Tape Reel |
| 2SA733-x-T92-B  | 2SA733L-x-T92-B   | TO-92   | E              | C | B | Tape Box  |
| 2SA733-x-T92-K  | 2SA733L-x-T92-K   | TO-92   | E              | C | B | Bulk      |

|   |   |
|---|---|
| <p>2SA733L-x-AE3-R</p> <p>(1)Packing Type<br/>(2)Package Type<br/>(3)Rank<br/>(4)Lead Plating</p> | <p>(1) B: Tape Box, K: Bulk, R: Tape Reel<br/>(2) AE3: SOT-23, AL3: SOT-323, T92: TO-92<br/>(3) x: refer to Classification of h<sub>FE</sub><br/>(4) L: Lead Free Plating, Blank: Pb/Sn</p> |
|---|---|

#### MARKING (For SOT Package)

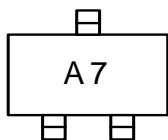

■ ABSOLUTE MAXIMUM RATING (Ta=25 , unless otherwise specified)

| PARAMETER                 | SYMBOL           | RATINGS    | UNIT |
|---------------------------|------------------|------------|------|
| Collector-Base Voltage    | V <sub>CBO</sub> | -60        | V    |
| Collector-Emitter Voltage | V <sub>CEO</sub> | -50        | V    |
| Emitter-Base Voltage      | V <sub>EBO</sub> | -5         | V    |
| Collector Dissipation     | SOT-23/SOT-323   | 250        | mW   |
|                           | TO-92            | 1          | W    |
| Collector Current         | I <sub>C</sub>   | -150       | mA   |
| Junction Temperature      | T <sub>J</sub>   | 125        |      |
| Storage Temperature       | T <sub>STG</sub> | -55 ~ +150 |      |

Note Absolute maximum ratings are those values beyond which the device could be permanently damaged.

Absolute maximum ratings are stress ratings only and functional device operation is not implied.

■ ELECTRICAL CHARACTERISTICS (Ta=25 , unless otherwise specified)

| PARAMETER                            | SYMBOL               | TEST CONDITIONS   | MIN | TYP  | MAX  | UNIT |
|--------------------------------------|----------------------|---|-----|------|------|------|
| Collector-Base Breakdown Voltage     | BV <sub>CBO</sub>    | I <sub>C</sub> =-100μA, I <sub>E</sub> =0                                     | -60 |      |      | V    |
| Collector-Emitter Breakdown Voltage  | BV <sub>CEO</sub>    | I <sub>C</sub> =-10mA, I <sub>B</sub> =0                                      | -50 |      |      | V    |
| Collector-Emitter Saturation Voltage | V <sub>CE(SAT)</sub> | I <sub>C</sub> =-100mA, I <sub>B</sub> =-10mA                                 |     | -0.1 | -0.3 | V    |
| Collector Cut-Off Current            | I <sub>CBO</sub>     | V <sub>CB</sub> =-40V, I <sub>E</sub> =0                                      |     |      | -100 | nA   |
| Emitter Cut-Off Current              | I <sub>EBO</sub>     | V <sub>EB</sub> =-3V, I <sub>C</sub> =0                                       |     |      | -100 | nA   |
| DC Current Gain                      | h <sub>FE</sub>      | V <sub>CE</sub> =-6V, I <sub>C</sub> =-1mA                                    | 90  |      | 600  |      |
| Current Gain Bandwidth Product       | f <sub>T</sub>       | V <sub>CE</sub> =-10V, I <sub>C</sub> =-50mA                                  | 100 | 190  |      | MHz  |
| Output Capacitance                   | C <sub>ob</sub>      | V <sub>CB</sub> =-10V, I <sub>E</sub> =0, f=1MHz                              |     | 2.0  | 3.0  | pF   |
| Noise Figure                         | NF                   | I <sub>C</sub> =-0.1mA, V <sub>CE</sub> =-6V<br>R <sub>G</sub> =10kΩ, f=100Hz |     | 4.0  | 6.0  | dB   |

■ CLASSIFICATION OF h<sub>FE</sub>

| RANK  | R      | Q       | P       | K       |
|-------|--------|---------|---------|---------|
| RANGE | 90-180 | 135-270 | 200-400 | 300-600 |

## ■ TYPICAL CHARACTERISTICS

Fig.1 Static Characteristics

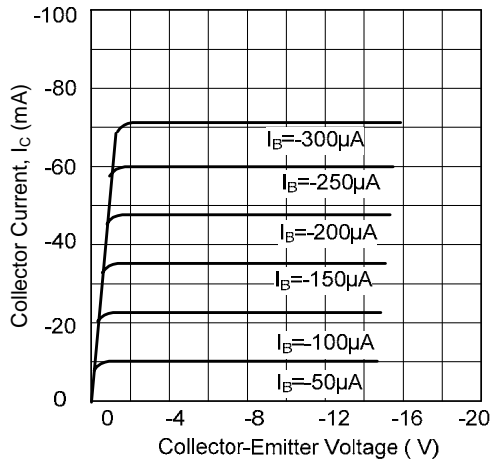

Fig.2 DC Current Gain

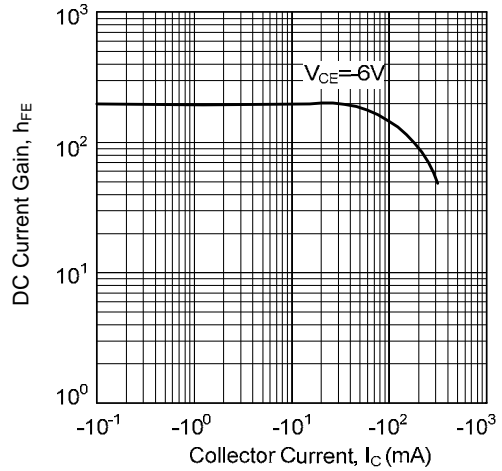

Fig.3 Base-Emmitter on Voltage

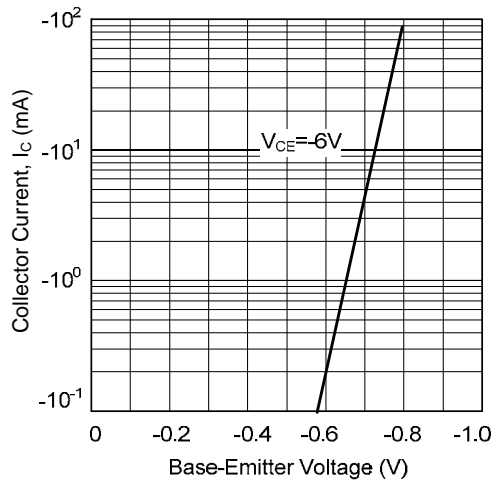

Fig.4 Saturation Voltage

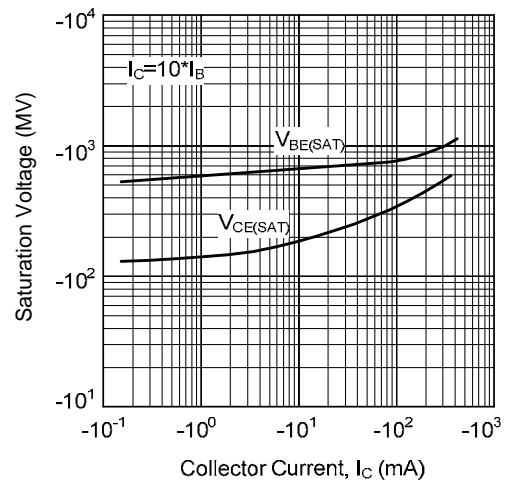

Fig.5 Current Gain-Bandwidth Product

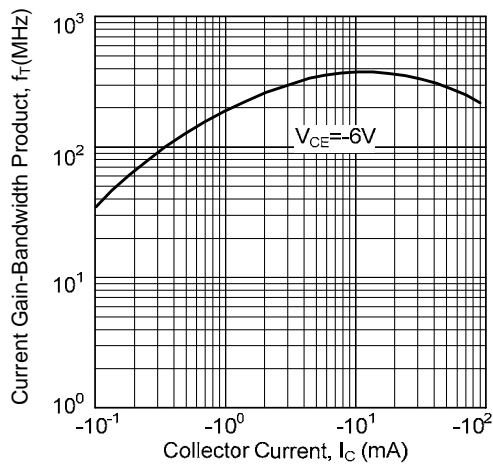
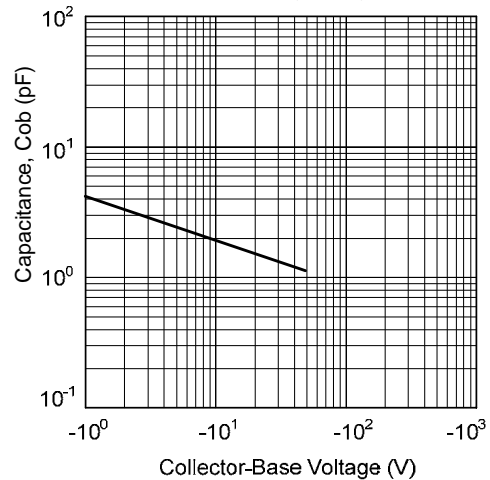

Fig.6 Collector Output Capacitance



UTC assumes no responsibility for equipment failures that result from using products at values that exceed, even momentarily, rated values (such as maximum ratings, operating condition ranges, or other parameters) listed in products specifications of any and all UTC products described or contained herein. UTC products are not designed for use in life support appliances, devices or systems where malfunction of these products can be reasonably expected to result in personal injury. Reproduction in whole or in part is prohibited without the prior written consent of the copyright owner. The information presented in this document does not form part of any quotation or contract, is believed to be accurate and reliable and may be changed without notice.