

2064 THRU 2069

QUAD 1.5 A DARLINGTON SWITCHES

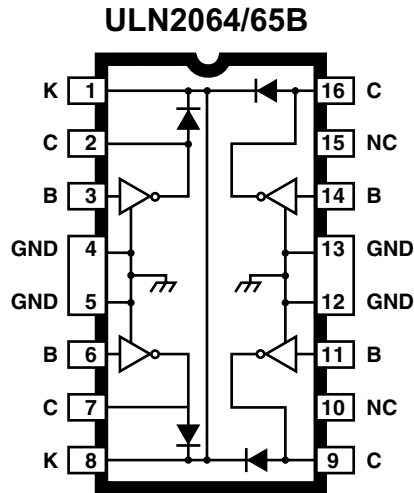

Dwg. No. A-9765A

ABSOLUTE MAXIMUM RATINGS at +25°C Free-Air Temperature for Any One Driver (unless otherwise noted)

Output Voltage, V_{CEX}	See Guide
Output Sustaining Voltage, $V_{CE(SUS)}$	See Guide
Output Current, I_{OUT} (Note 1)	1.75 A
Input Voltage, V_{IN}	See Guide
Input Current, I_B (Note 2)	25 mA
Supply Voltage, V_S (ULN2068B/LB & 2069B/LB) ...	10 V
Total Package Power Dissipation, P_D	See Graph
Operating Temperature Range, T_A	-20°C to +85°C
Storage Temperature Range, T_S	-55°C to -150°C

1. Allowable combinations of output current, number of outputs conducting, and duty cycle are shown on the following pages.
2. Input current may be limited by maximum allowable input voltage.

High-voltage, high-current Darlington arrays ULN2064B/LB through ULN2069B/LB are designed for interface between low-level logic and a variety of peripheral loads such as relays, solenoids, dc and stepper motors, magnetic print hammers, multiplexed LED and incandescent displays, heaters, and similar loads. Output off voltage ratings of 50 V and 80 V are available. These quad drivers can drive resistive loads to 480 watts (1.5 A x 80 V, 26% duty cycle). For inductive loads, sustaining voltages of 35 V and 50 V at 100 mA are specified.

Quad drivers ULN2064B/LB, ULN2065B/LB, ULN2068B/LB, and ULN2069B/LB are intended for use with TTL, low-speed TTL, and 5 V MOS logic. The ULN2065B/LB and ULN2069B/LB are selected for the 80 V minimum output breakdown specification. The ULN2068B/LB and ULN2069B/LB have pre-driver stages and are recommended for applications requiring high gain (low input-current loading). Quad-driver arrays are supplied with heat-sink contact tabs in 16-pin plastic DIPs (suffix 'B') and 20-lead surface-mountable wide-body SOICs (suffix 'LB').

FEATURES

- TTL, DTL, MOS, CMOS Compatible Inputs
- Transient-Protected Outputs
- Loads to 480 Watts
- Heat-Sink Contact Tabs
- Automotive Capable

Always order by complete part number, e.g., **ULN2064B**.

2064 THRU 2069 QUAD 1.5 A DARLINGTON SWITCHES

SELECTION GUIDE

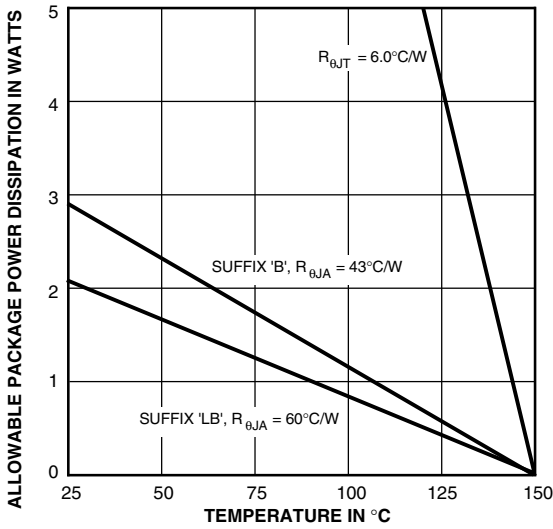

Dwg. GP-049-3

Part Number*	Max. V_{CEX}	Min. $V_{CE(SUS)}$	Max. V_{IN}	Application
ULN2064B ULN2064LB	50 V	35 V	15 V	TTL, DTL, Schottky TTL, and 5 V CMOS
ULN2065B ULN2065LB	80 V	50 V	15 V	
ULN2068B ULN2068LB	50 V	35 V	15 V	TTL, DTL, Schottky TTL, and 5 V CMOS
ULN2069B ULN2069LB	80 V	50 V	15 V	

* Suffix 'B' is a 16-pin DIP; 'LB' is a 20-lead SOIC.

TEST FIGURES

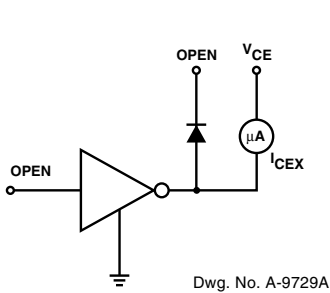

FIGURE 1

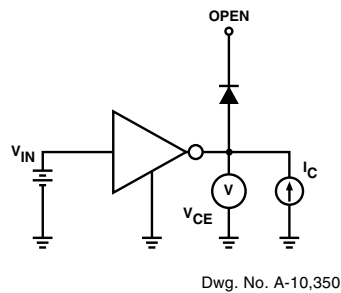

FIGURE 2

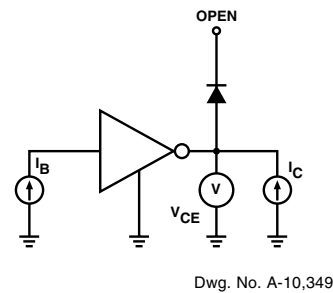

FIGURE 3

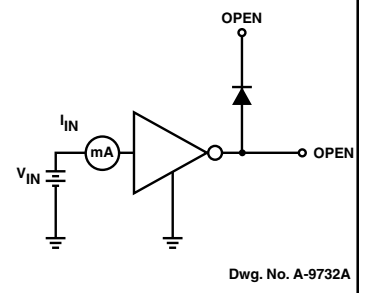

FIGURE 4

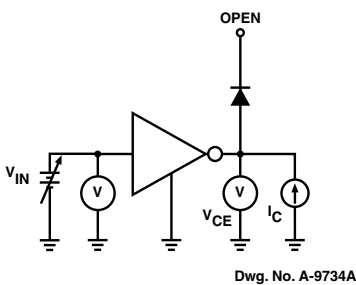

FIGURE 5

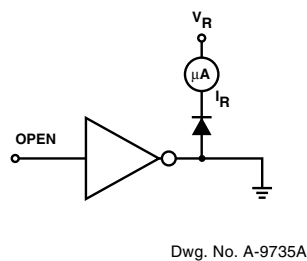

FIGURE 6

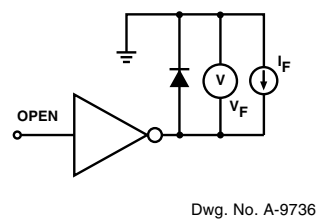

FIGURE 7

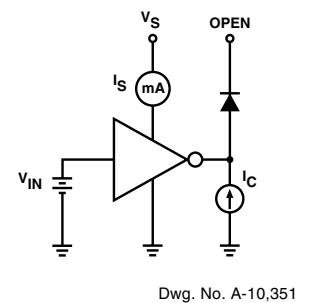
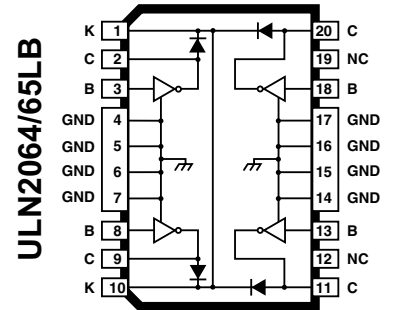
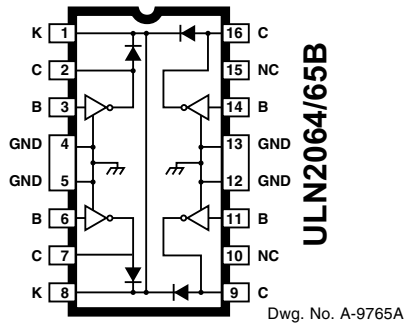
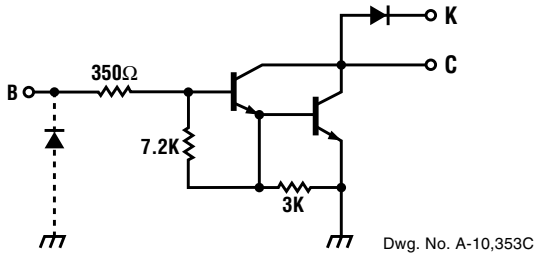

FIGURE 8

2064 THRU 2069 QUAD 1.5 A DARLINGTON SWITCHES

PARTIAL SCHEMATIC



ELECTRICAL CHARACTERISTICS at +25°C (unless otherwise noted).

Characteristic	Symbol	Test Fig.	Applicable Devices	Test Conditions	Limits		
					Min.	Max.	Units
Output Leakage Current	I_{CEX}	1	ULN2064B/LB	$V_{CE} = 50\text{ V}$	—	100	μA
				$V_{CE} = 50\text{ V}, T_A = 70^\circ\text{C}$	—	500	μA
			ULN2065B/LB	$V_{CE} = 80\text{ V}$	—	100	μA
				$V_{CE} = 80\text{ V}, T_A = 70^\circ\text{C}$	—	500	μA
Output Sustaining Voltage	$V_{CE(SUS)}$	2	ULN2064B/LB	$I_C = 100\text{ mA}, V_{IN} = 0.4\text{ V}$	35	—	V
			ULN2065B/LB	$I_C = 100\text{ mA}, V_{IN} = 0.4\text{ V}$	50	—	V
Collector-Emitter Saturation Voltage	$V_{CE(SAT)}$	3	All	$I_C = 500\text{ mA}, I_B = 625\text{ }\mu\text{A}$	—	1.1	V
				$I_C = 750\text{ mA}, I_B = 935\text{ }\mu\text{A}$	—	1.2	V
				$I_C = 1.0\text{ A}, I_B = 1.25\text{ mA}$	—	1.3	V
				$I_C = 1.25\text{ A}, I_B = 2.0\text{ mA}$	—	1.4	V
			ULN2065B/LB	$I_C = 1.5\text{ A}, I_B = 2.25\text{ mA}$	—	1.5	V
Input Current	$I_{IN(ON)}$	4	All	$V_{IN} = 2.4\text{ V}$	1.4	4.3	mA
				$V_{IN} = 3.75\text{ V}$	3.3	9.6	mA
Input Voltage	$V_{IN(ON)}$	5	All	$V_{CE} = 2.0\text{ V}, I_C = 1.0\text{ A}$	—	2.0	V
			ULN2064B/LB	$V_{CE} = 2.0\text{ V}, I_C = 1.25\text{ A}$	—	2.5	V
			ULN2065B/LB	$V_{CE} = 2.0\text{ V}, I_C = 1.5\text{ A}$	—	2.5	V
Turn-On Delay	t_{PLH}	—	All	$0.5 E_{in}$ to $0.5 E_{out}$	—	1.0	μs
Turn-Off Delay	t_{PHL}	—	All	$0.5 E_{in}$ to $0.5 E_{out}$	—	1.5	μs
Clamp Diode Leakage Current	I_R	6	ULN2064B/LB	$V_R = 50\text{ V}$	—	50	μA
				$V_R = 50\text{ V}, T_A = 70^\circ\text{C}$	—	100	μA
			ULN2065B/LB	$V_R = 80\text{ V}$	—	50	μA
				$V_R = 80\text{ V}, T_A = 70^\circ\text{C}$	—	100	μA
Clamp Diode Forward Voltage	V_F	7	All	$I_F = 1.0\text{ A}$	—	1.75	V
				$I_F = 1.5\text{ A}$	—	2.0	V

2064 THRU 2069 QUAD 1.5 A DARLINGTON SWITCHES

PARTIAL SCHEMATIC

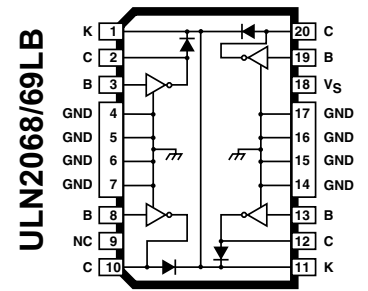
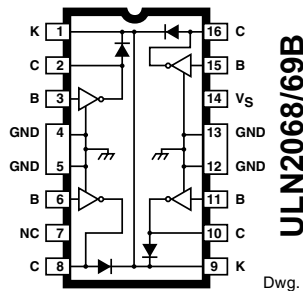
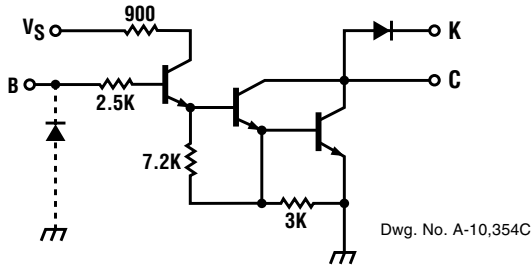

ELECTRICAL CHARACTERISTICS at +25°C, $V_S = 5.0\text{ V}$ (unless otherwise noted).

Characteristic	Symbol	Test Fig.	Applicable Devices	Test Conditions	Limits		
					Min.	Max.	Units
Output Leakage Current	I_{CEX}	1	ULN2068B/LB	$V_{CE} = 50\text{ V}$	—	100	μA
				$V_{CE} = 50\text{ V}, T_A = 70^\circ\text{C}$	—	500	μA
			ULN2069B/LB	$V_{CE} = 80\text{ V}$	—	100	μA
				$V_{CE} = 80\text{ V}, T_A = 70^\circ\text{C}$	—	500	μA
Output Sustaining Voltage	$V_{CE(SUS)}$	2	ULN2068B/LB	$I_C = 100\text{ mA}, V_{IN} = 0.4\text{ V}$	35	—	V
			ULN2069B/LB	$I_C = 100\text{ mA}, V_{IN} = 0.4\text{ V}$	50	—	V
Collector-Emitter Saturation Voltage	$V_{CE(SAT)}$	3	All	$I_C = 500\text{ mA}, V_{IN} = 2.75\text{ V}$	—	1.1	V
				$I_C = 750\text{ mA}, V_{IN} = 2.75\text{ V}$	—	1.2	V
				$I_C = 1.0\text{ A}, V_{IN} = 2.75\text{ V}$	—	1.3	V
				$I_C = 1.25\text{ A}, V_{IN} = 2.75\text{ V}$	—	1.4	V
			ULN2069B/LB	$I_C = 1.5\text{ A}, V_{IN} = 2.75\text{ V}$	—	1.5	V
Input Current	$I_{IN(ON)}$	4	All	$V_{IN} = 2.75\text{ V}$	—	550	μA
				$V_{IN} = 3.75\text{ V}$	—	1000	μA
Input Voltage	$V_{IN(ON)}$	5	ULN2068B/LB	$V_{CE} = 2.0\text{ V}, I_C = 1.25\text{ A}$	—	2.75	V
			ULN2069B	$V_{CE} = 2.0\text{ V}, I_C = 1.5\text{ A}$	—	2.75	V
Supply Current	I_S	8	All	$I_C = 500\text{ mA}, V_{IN} = 2.75\text{ V}$	—	6.0	mA
Turn-On Delay	t_{PLH}	—	All	$0.5 E_{in}$ to $0.5 E_{out}$	—	1.0	μs
Turn-Off Delay	t_{PHL}	—	All	$0.5 E_{in}$ to $0.5 E_{out}, I_C = 1.25\text{ A}$	—	1.5	μs
Clamp Diode Leakage Current	I_R	6	ULN2068B/LB	$V_R = 50\text{ V}$	—	50	μA
				$V_R = 50\text{ V}, T_A = 70^\circ\text{C}$	—	100	μA
			ULN2069B/LB	$V_R = 80\text{ V}$	—	50	μA
				$V_R = 80\text{ V}, T_A = 70^\circ\text{C}$	—	100	μA
Clamp Diode Forward Voltage	V_F	7	All	$I_F = 1.0\text{ A}$	—	1.75	V
				$I_F = 1.5\text{ A}$	—	2.0	V

2064 THRU 2069 QUAD 1.5 A DARLINGTON SWITCHES

PEAK COLLECTOR CURRENT AS A FUNCTION OF DUTY CYCLE (Dual in-line packaged devices)

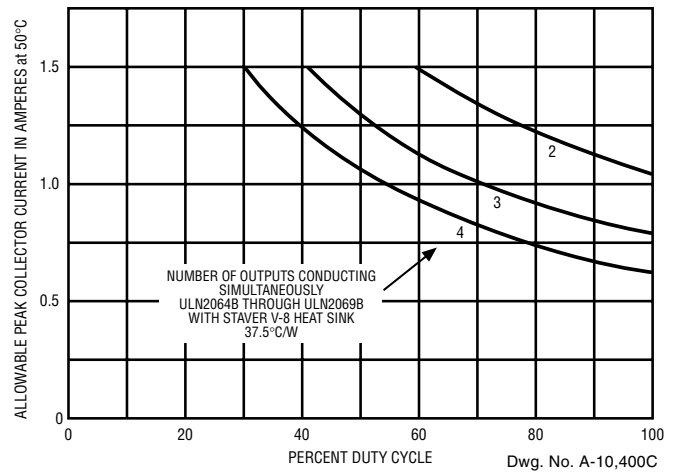
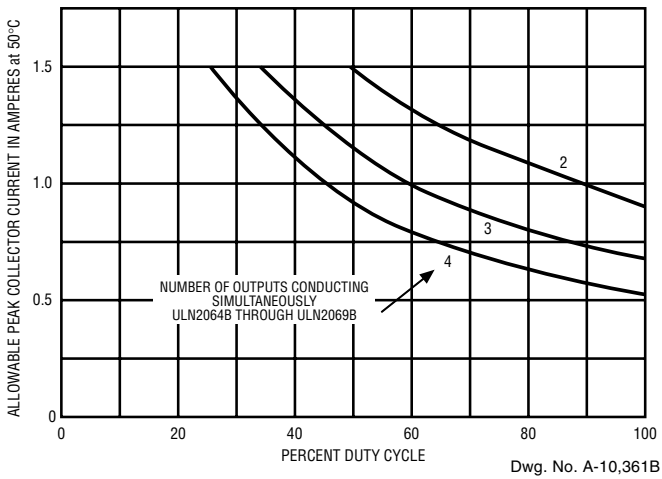
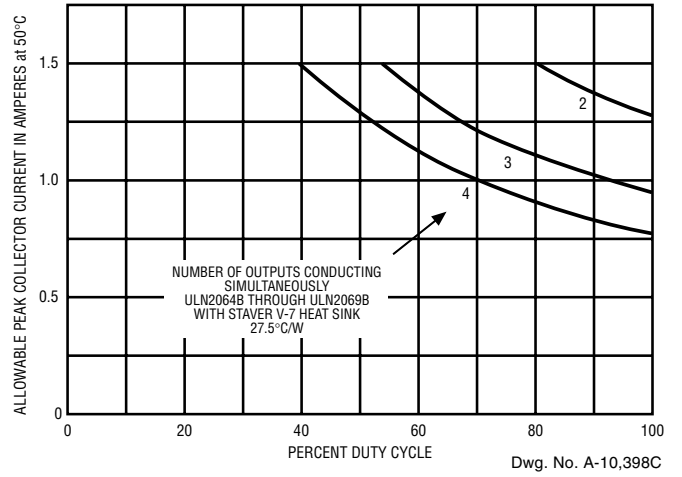
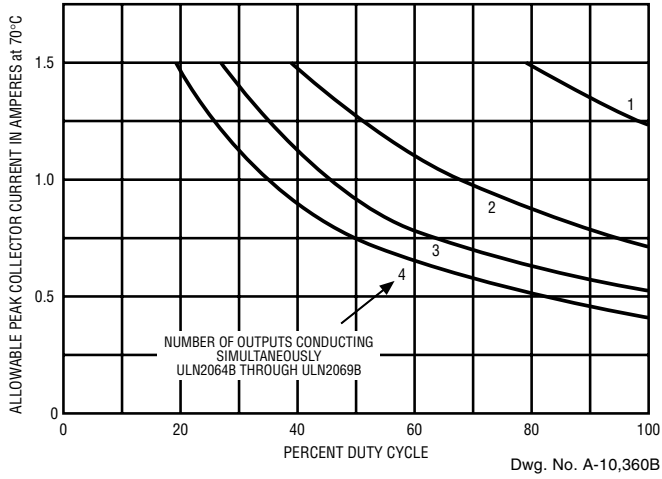

2064 THRU 2069
QUAD 1.5 A DARLINGTON
SWITCHES

PEAK COLLECTOR CURRENT AS A FUNCTION OF DUTY CYCLE
 (Dual in-line packaged devices)

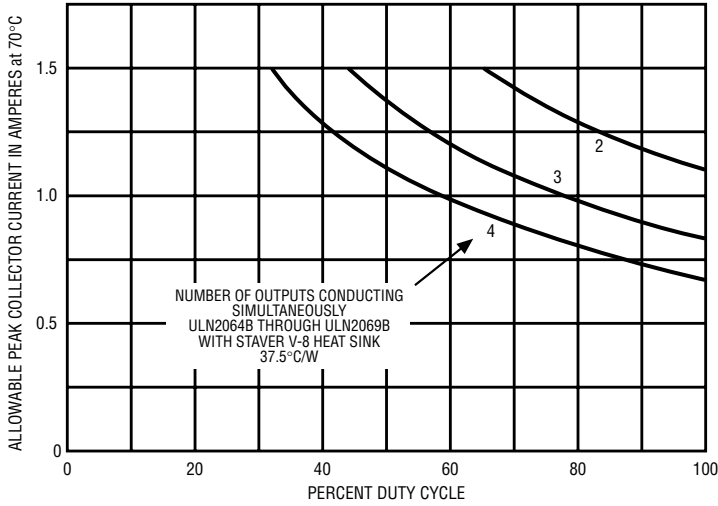

Dwg. No. A-10,399C

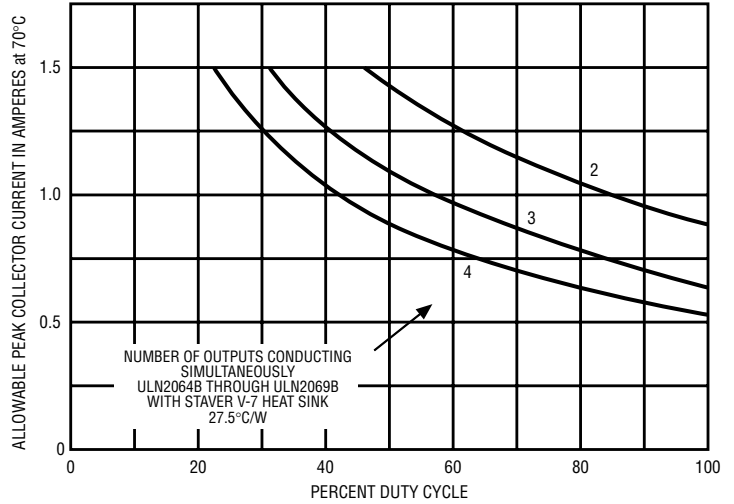

Dwg. No. A-10,401C

PEAK COLLECTOR CURRENT AS A FUNCTION OF DUTY CYCLE
 (SOIC packaged devices)

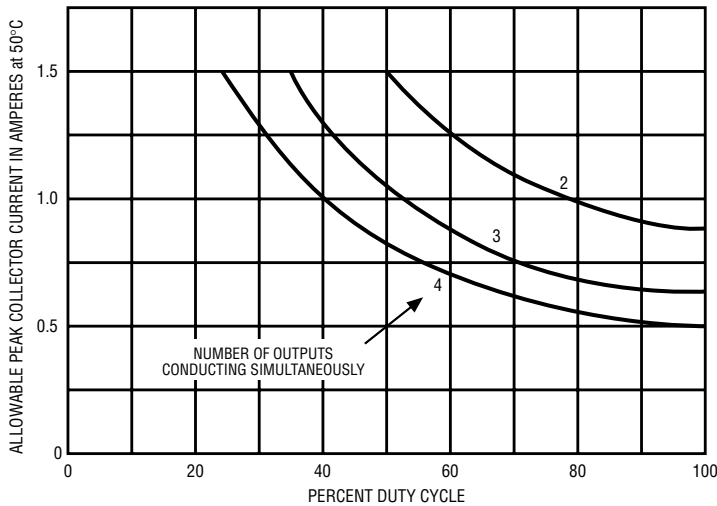

Dwg. GP-045

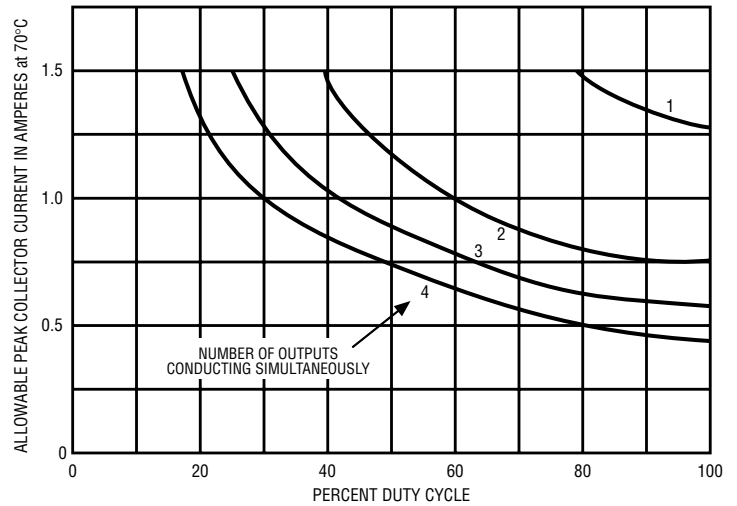

Dwg. GP-045-1

2064 THRU 2069
QUAD 1.5 A DARLINGTON
SWITCHES

INPUT CURRENT AS A FUNCTION OF INPUT VOLTAGE AT +25°C

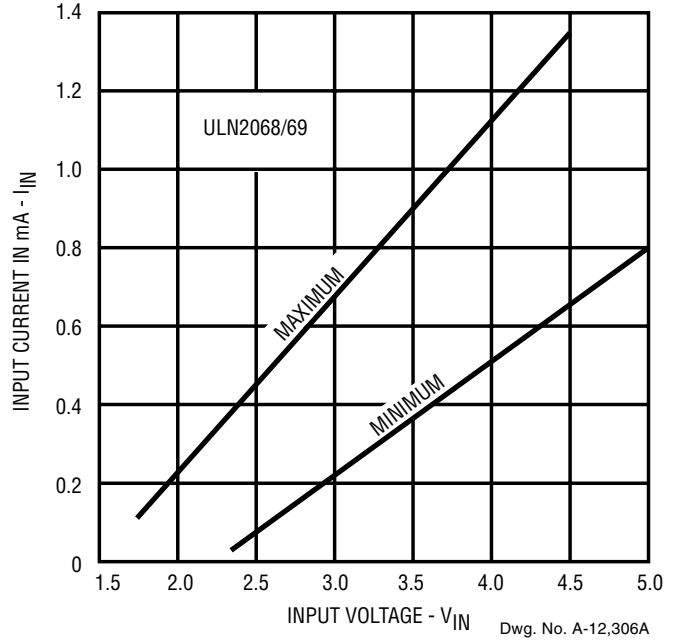
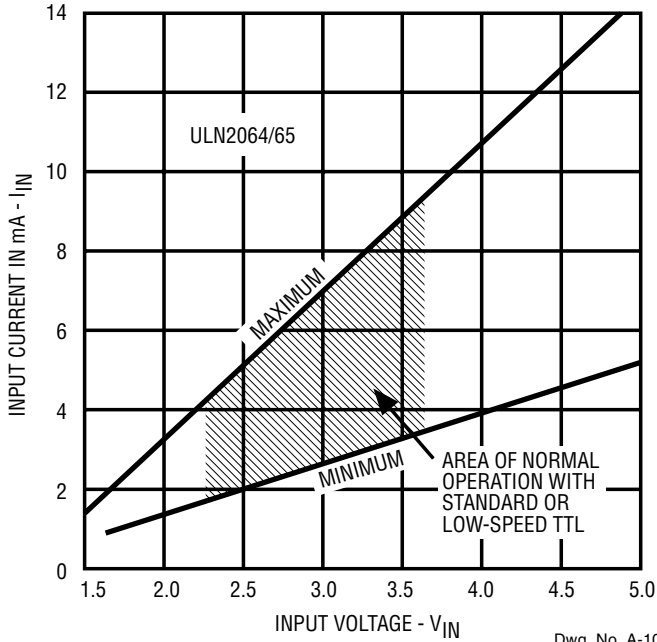

COLLECTOR CURRENT AS A FUNCTION OF INPUT CURRENT AT +25°C

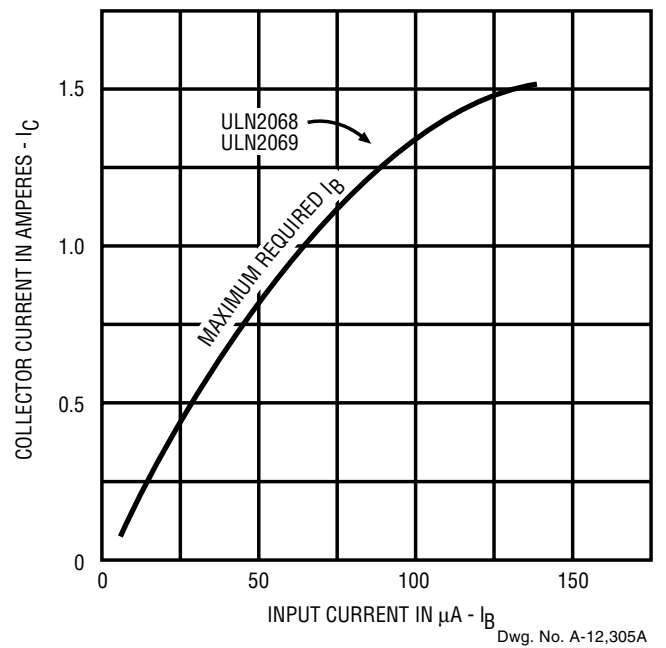
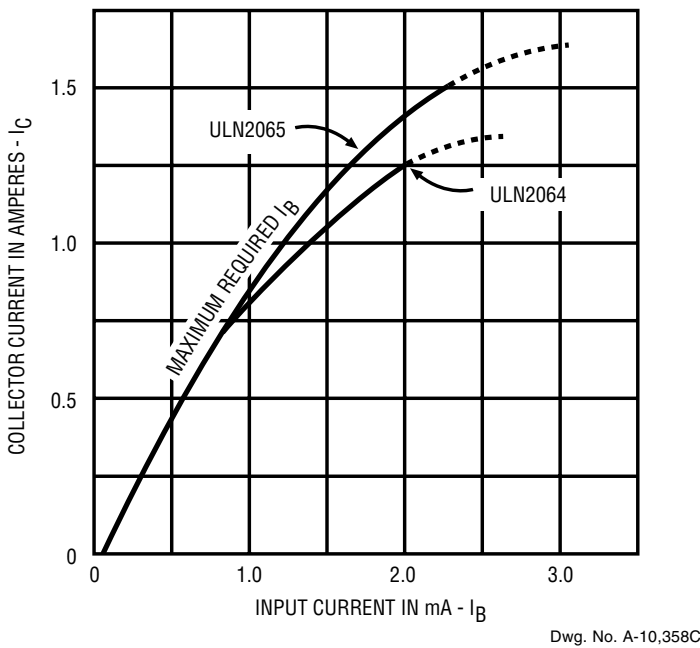

2064 THRU 2069
QUAD 1.5 A DARLINGTON
SWITCHES

TYPICAL APPLICATION

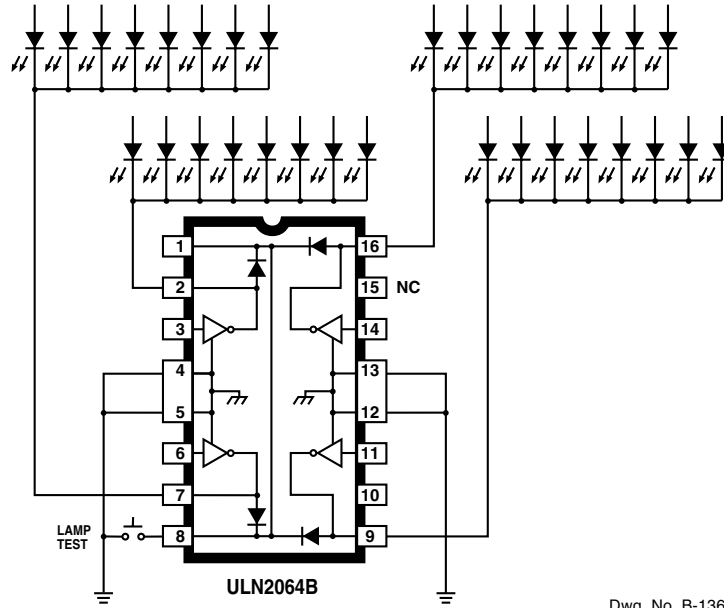

Dwg. No. B-1365

COMMON-CATHODE LED DRIVERS
 (Types ULN2068B and ULN2068LB are also applicable)

2064 THRU 2069 QUAD 1.5 A DARLINGTON SWITCHES

ULN2064B, ULN2065B, ULN2068B, and ULN2069B

Dimensions in Inches (controlling dimensions)

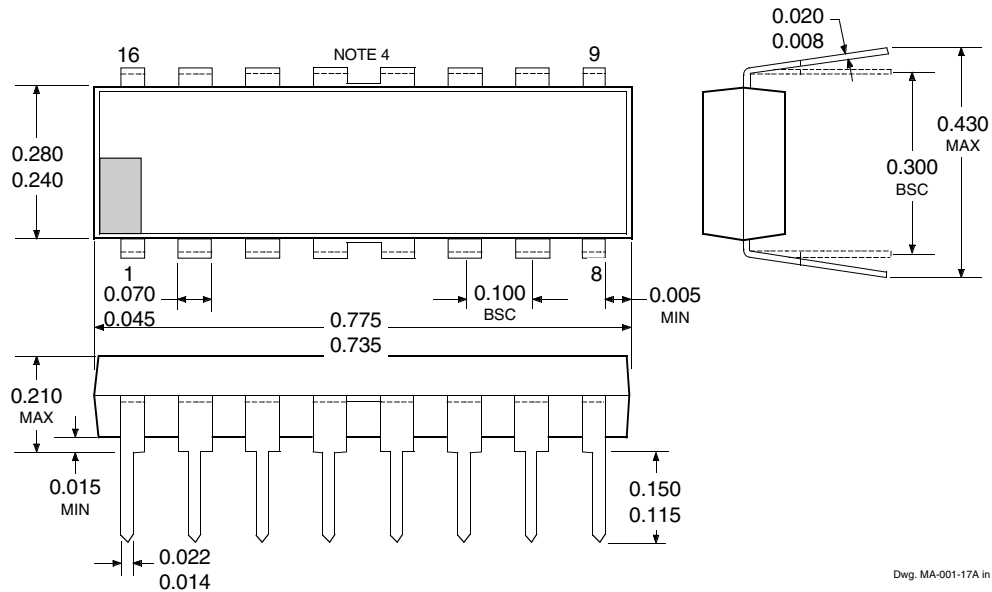

Dimensions in Millimeters (for reference only)

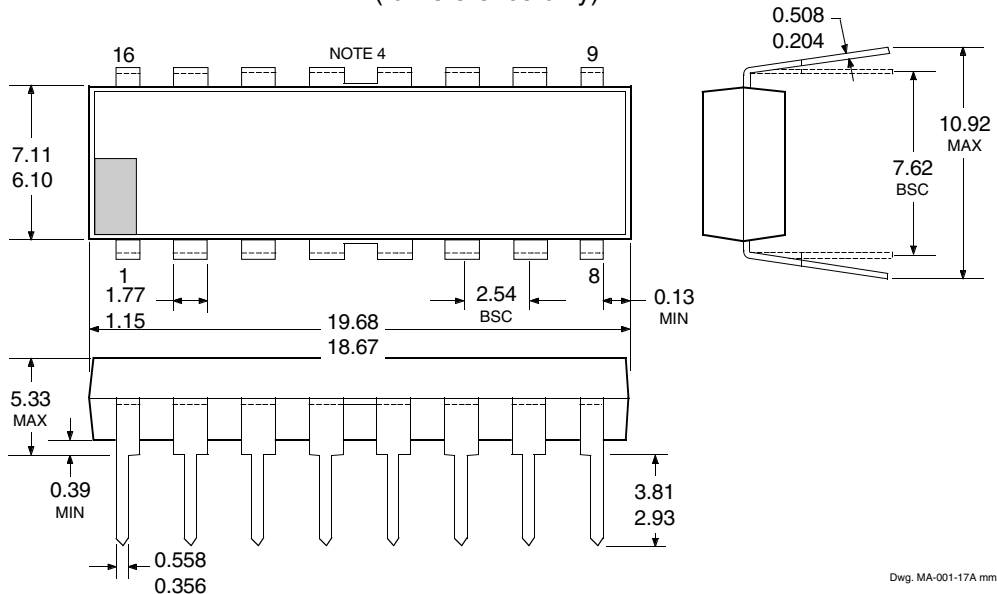

- NOTES:
1. Exact body and lead configuration at vendor's option within limits shown.
 2. Lead spacing tolerance is non-cumulative.
 3. Lead thickness is measured at seating plane or below.
 4. Webbed lead frame. Leads 4, 5, 12, and 13 are internally one piece.
 5. Supplied in standard sticks/tubes of 25 devices.

2064 THRU 2069
QUAD 1.5 A DARLINGTON
SWITCHES

ULN2064LB, ULN2065LB, ULN2068LB, and ULN2069LB
 (add "TR" to part number for tape and reel)

Dimensions in Inches
 (for reference only)

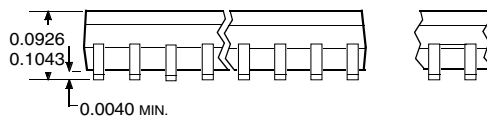
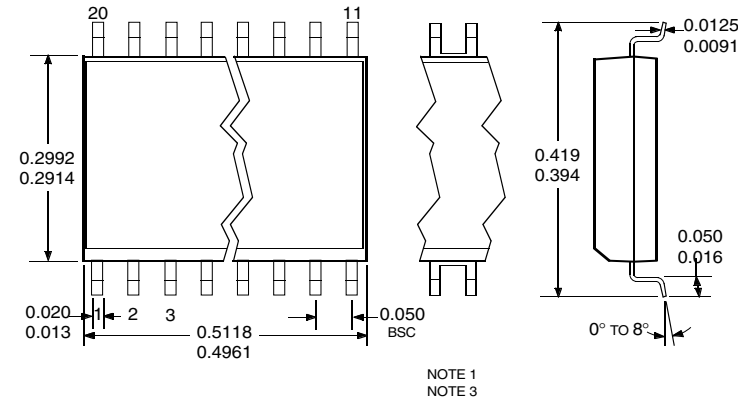

Dwg. MA-008-21A in

Dimensions in Millimeters
 (controlling dimensions)

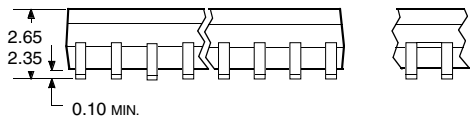
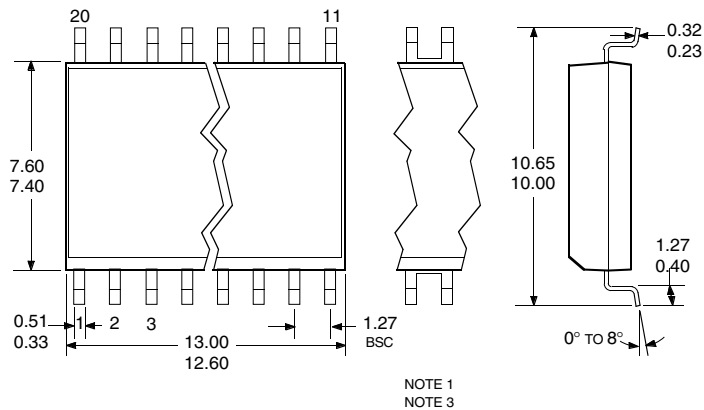

Dwg. MA-008-21A mm

- NOTES:
1. Exact body and lead configuration at vendor's option within limits shown.
 2. Lead spacing tolerance is non-cumulative.
 3. Webbed lead frame. Leads 4 through 7 and 14 through 17 are internally one piece.
 4. Lead thickness is measured at seating plane or below.
 5. Supplied in standard sticks/tubes of 37 devices or add "TR" to part number for tape and reel.

2064 THRU 2069
QUAD 1.5 A DARLINGTON
SWITCHES

The products described here are manufactured under one or more U.S. patents or U.S. patents pending.

Allegro MicroSystems, Inc. reserves the right to make, from time to time, such departures from the detail specifications as may be required to permit improvements in the performance, reliability, or manufacturability of its products. Before placing an order, the user is cautioned to verify that the information being relied upon is current.

Allegro products are not authorized for use as critical components in life-support devices or systems without express written approval.

The information included herein is believed to be accurate and reliable. However, Allegro MicroSystems, Inc. assumes no responsibility for its use; nor for any infringement of patents or other rights of third parties which may result from its use.

2064 THRU 2069
QUAD 1.5 A DARLINGTON
SWITCHES

POWER SINK DRIVERS

IN ORDER OF 1) OUTPUT CURRENT, 2) OUTPUT VOLTAGE, 3) NUMBER OF DRIVERS

Output Ratings *			Features					Part Number †
mA	V	#	Serial Input	Latched Drivers	Diode Clamp	Outputs	Internal Protection	
75	17	8	X	X	–	constant current	–	6275
	17	16	X	X	–	constant current	–	6276
100	20	8	–	–	–	saturated	–	2595
	30	32	X	X	–	–	–	5833
	40	32	X	X	–	saturated	–	5832
	50	8	–	–	–	addressable decoder/driver	DMOS	6B259
	50	8	–	X	–	–	DMOS	6B273
	50	8	X	X	–	–	DMOS	6B595
250	50	8	–	–	–	addressable decoder/driver	DMOS	6259
	50	8	–	X	–	–	DMOS	6273
	50	8	X	X	–	–	DMOS	6595
	135	7	–	–	X	–	–	7003
300	45	1	–	Hall sensor/driver	X	–	X	5140
	50	8	–	–	X	saturated	–	2596
	60	4	–	–	X	saturated	X	2557
350	50	4	–	X	X	–	–	5800
	50	7	–	–	X	–	–	2003
	50	7	–	–	X	–	–	2004
	50	8	–	–	X	–	–	2803
	50	8	–	–	X	–	–	2804
	50	8	–	X	X	–	–	5801
	50	8	X	X	–	–	–	5821
	50	8	X	X	X	–	–	5841
	50	8	–	–	–	addressable decoder/driver	DMOS	6A259
	50	8	X	X	–	–	DMOS	6A595
	80	8	X	X	–	–	–	5822
	80	8	X	X	X	–	–	5842
	95	7	–	–	X	–	–	2023
	95	7	–	–	X	–	–	2024
	95	8	–	–	X	–	–	2823
	95	8	–	–	X	–	–	2824
450	30	28	–	–	–	dual 4- to 14-line decoder/driver	–	6817
600	60	4	–	–	–	saturated	X	2547
	60	4	–	–	X	saturated	X	2549 and 2559
700	60	4	–	–	X	saturated	X	2543
750	50	8	–	–	X	saturated	–	2597
900	14	2	–	Hall sensor/driver	X	saturated	X	3625
	26	2	–	Hall sensor/driver	X	saturated	X	3626
1000	46	4	–	–	–	stepper motor controller/driver	MOS	7024 and 7029
1200	46	4	–	–	–	microstepping controller/driver	MOS	7042
1250	50	4	–	–	–	stepper motor translator/driver	–	5804
	50	4	–	–	X	–	–	2064 and 2068
1500	80	4	–	–	X	–	–	2065 and 2069
1800	50	4	–	–	X	–	–	2544
	50	4	–	–	X	–	–	2540
3000	46	4	–	–	–	stepper motor controller/driver	MOS	7026
	46	4	–	–	–	microstepping controller/driver	MOS	7044
4000	50	4	–	–	X	–	–	2878
	80	4	–	–	X	–	–	2879

* Current is maximum specified test condition, voltage is maximum rating. See specification for sustaining voltage limits or over-current protection voltage limits.

† Complete part number includes additional characters to indicate operating temperature range and package style.