

RED**TOSHIBA T-1¾ InGaAlP Ultra Bright LED**

TLRME16TP

Product Features -

- InGaAlP Technology
- T-1¾ (5 mm) Package
- Water Clear Lens

MAXIMUM RATINGS (Ta = 25°C)

CHARACTERISTIC	SYMBOL	RATING	UNIT
Forward Current	I_F	50	mA
Reverse Voltage	V_R	4	V
Power Dissipation	P_D	120	mW
Operating Temperature	T_{opr}	-40 ~ 120	°C
Storage Temperature	T_{stg}	-40 ~ 120	°C

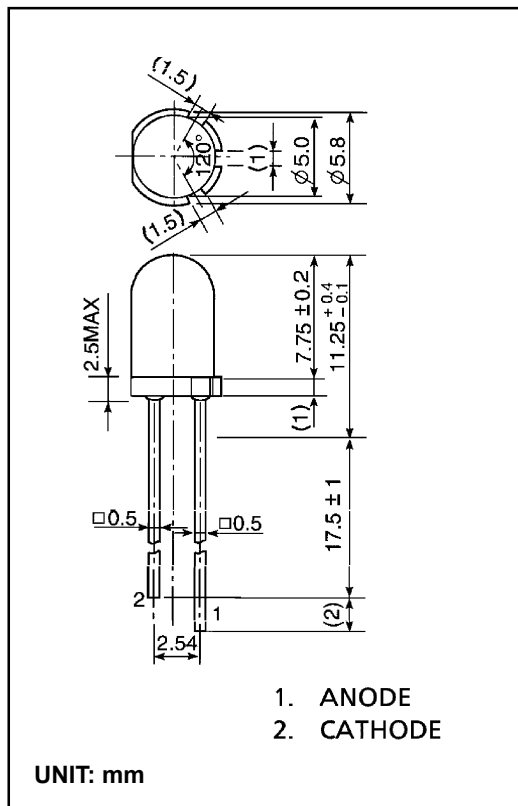

OPTO-ELECTRICAL CHARACTERISTICS (Ta = 25°C)

CHARACTERISTIC	SYMBOL	TEST CONDITION	MIN.	TYP.	MAX.	UNIT
Forward Voltage	V_F	$I_F = 20\text{mA}$	—	1.9	2.4	V
Reverse Current	I_R	$V_R = 4\text{V}$	—	—	50	μA
Luminous Intensity	I_v	$I_F = 20\text{mA}$	272	1200	—	mcd
Viewing Angle	$2\theta_{1/2}$	—	—	24	—	°
Peak Wavelength	λ_p	$I_F = 20\text{mA}$	—	636	—	nm
Dominant Wavelength	λ_d	$I_F = 20\text{mA}$	—	626	—	nm
Spectral Line Half Width	$\Delta\lambda$	$I_F = 20\text{mA}$	—	23	—	nm

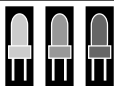

marktech
optoelectronics

120 Broadway • Menands, New York 12204

Toll Free: (800) 98-4LEDS • Fax: (518) 432-7454

TLRME16TP Graphs -

