

Features

- stable film structure
- good stability
- superior moisture resistance
- for use in professional electronics

Style – SOVCOR

Style	P at 70°C	Limit. Voltage V ≈	TC ¹⁾ ppm/°C	Tolerance %		Resistance Range Ω	E-Series	
NT3S	0,125	200	15	0,1 ... 1		1K – 200K	192	
NP3S	0,25	200	25	0,1	0,25	1K – 200K	192	192
				0,5	1	100 – 200K	192	96
NY3	0,25	200	50	0,5		10 – 1M	192	
				1		10 – 1,5M	96	
NK3	0,25	200	100	1		10 – 1,5M	96	
				2	5	4,7 – 1,5M	24	
NT4S	0,25	350	15	0,1 ... 1		100 – 499K	96 – 192	
NP4S	0,5	350	25	0,1 ... 1		100 – 1M	96 – 192	
NY4	0,5	350	50	0,5		10 – 1M	192	
				1		10 – 3,01M	96	
NK4	0,5	350	100	2	5	1 – 3M	24	
N4	0,5	350	200	2	5	1 – 3M	24	
NT5S	0,5	350	15	0,1 ... 1		100 – 499K	96 – 192	
NP5S	0,5	350	25	0,1 ... 1		100 – 1M	96 – 192	
NY5	0,5	350	50	0,5		10 – 1M	192	
				1		10 – 3,92M	96	
NK5	0,5	350	100	2	5	5,1 – 3,9M	24	
N5	0,5	350	200	2	5	5,1 – 3,9M	24	

¹⁾ for TC ≤ 15 ppm/°C: temperature range –25°C ... +85°C

• coating: dark green
• marking: see page 128

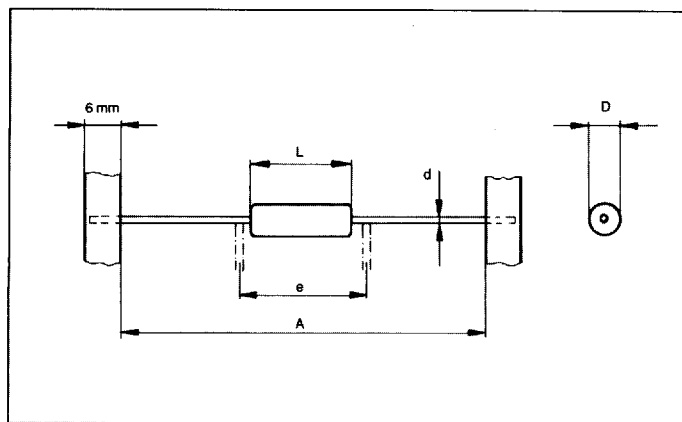

Style	Dimensions (mm)				
	D _{max}	L _{max}	A	d	e
N..3..	1,8	3,9	53	0,5	5,08
N..4..	2,5	6,2	53	0,6	7,62
N..5..	3,3	8,7	53	0,6	12,70

• The NK3 resistor can be cropped and bent to 5.08 mm pitch.

• taping corresponds to IEC286 and EIA296D, see page 102
• D and L measured in accordance with IEC294
• d according to IEC301

Technical Characteristics

Parameter	Unit	NT3S	N..3	NT4S	NT..4	NT..5
Power Rating at 70°C	W	0,125	0,25	0,25	0,5	0,5
Limiting Element Voltage	V ≈	200	200	350	350	350
Isolation Voltage	V-	>500	>500	>700	>700	>700
Thermal Resistance (maximum)	K/W	170	170	145	145	110
Terminal Strength, axial	N	>40	>40	>50	>50	>50
Weight	g	0,15	0,15	0,30	0,30	0,50
Failure Rate	10 ⁻⁹ /h	≤10				
Insulation Resistance	Ω	≥10 ¹¹				
Category Temperature Range	°C	-55/+155 ¹⁾				

¹⁾ for TC ≤15 ppm/°C: temperature range -25°C ... +85°C

Ordering Information

NK3 Style	1,8K Resistance Value Ω	± 2 Tolerance %	A5 Packaging
---------------------	--------------------------------------	------------------------------	------------------------

Packaging

Style	Tolerance %	TC ppm/°C	pieces/reel	min. quantity per order	pieces/box	min. quantity per order
NT3S/NP3S	0,1 ... 1	15 - 25	5000	1	100	1
NY3	0,5	50	5000	1	500	1
NY3	1	50	5000	1	1000	1
NK3	1 ... 5	100	5000	1	1000	1
NY3CC/NK3CC	1 ... 5	50 - 100	-	-	500	1
NT4S/NP4S	0,1 ... 1	15 - 25	5000	1	100	1
NY4	0,5 ... 1	50	5000	1	500	1
NK4/N4	2 ... 5	100 - 200	5000	1	1000	1
NT5S/NP5S	0,1 ... 1	15 - 25	2500	1	100	1
NY5/NK5/N5	0,5 ... 5	50 - 20	2500	1	500	1

• further information about packaging: see page 102

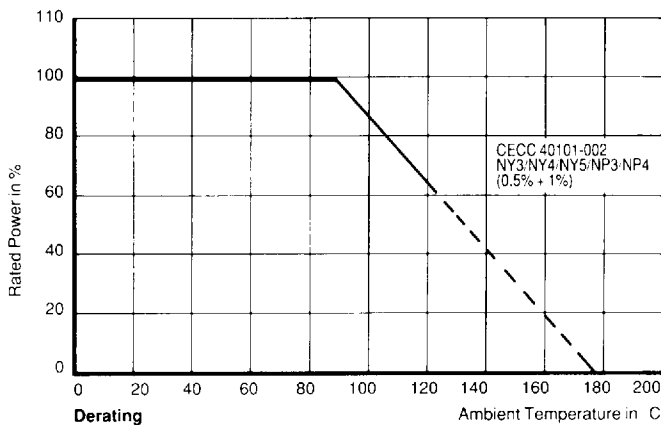
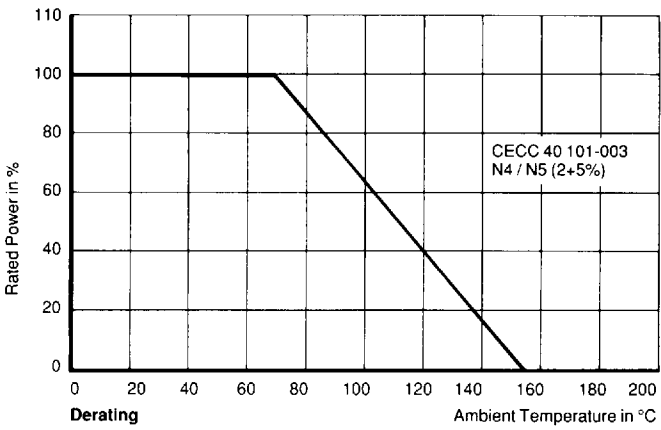
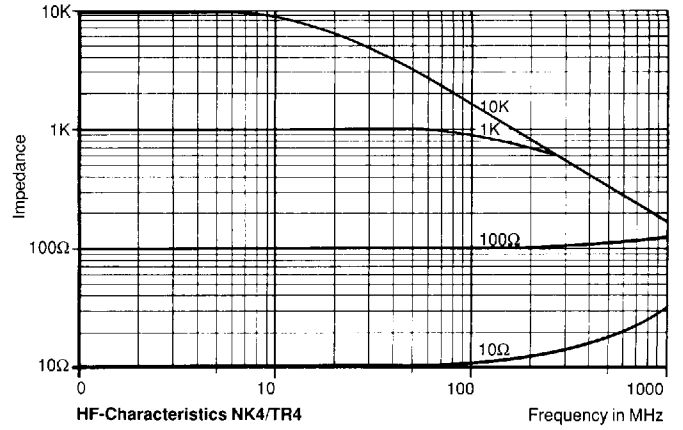
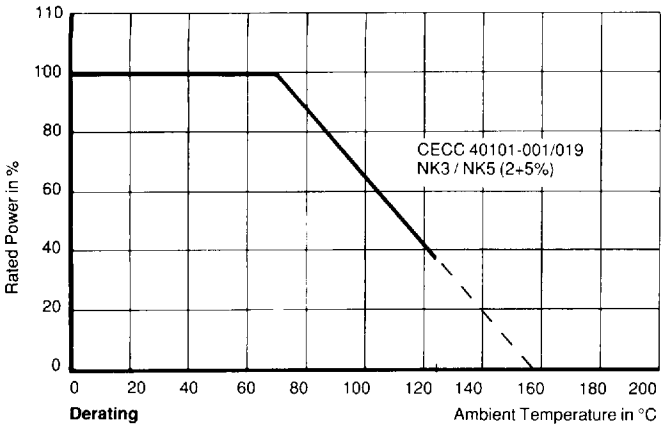

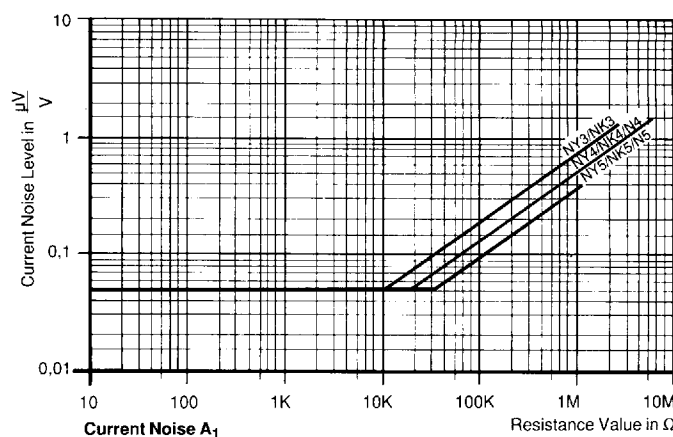
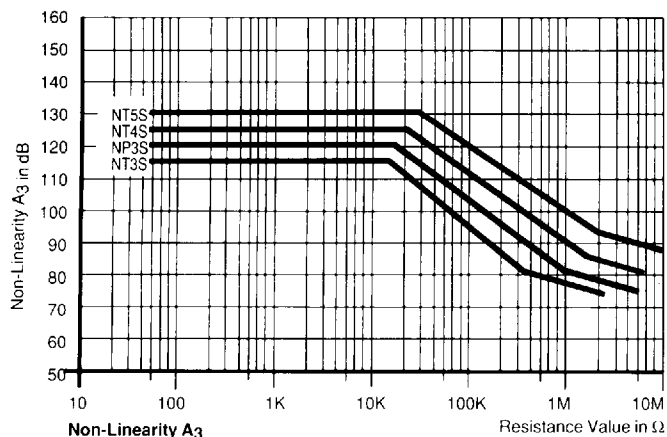

Performance

Test	Conditions of test	*)	test results
Endurance at 70°C rated power (P ₇₀)	IEC 115-1 4.25.1 1000 h at 70°C	1 2 3	≤ ±0,15% ≤ ±0,1% ≤ ±0,1% ... ±0,4%
Endurance at upper category temperature	IEC 115-1 4.25.3 1000 h at 155°C	1 2 3	≤ ±0,2% ≤ ±0,15% ≤ ±0,2%
Overload-Test	IEC 115-1 4.13 2,5 x rated power or twice the limiting element voltage 2s for N..3.. and 5s styles >N..3..	1 2 3	≤ ±0,03% ≤ ±0,01% ≤ ±0,03%
Thermal Shock	IEC 115-1 4.16 IEC 68-2-14 Rapid change between upper and lower category temperature	1 2 3	≤ ±0,04%
Climatic sequence	IEC 115-1 4.23 dry heat, damp heat cyclic, cold, low air pressure	1 2 3	≤ ±0,1%
Damp heat steady state	IEC 115-1 4.24 IEC 68-2-3 56 days at 40°C and 93% relative humidity and U = 0,1 x rated power	1 2 3	≤ ±0,2%
Resistance to soldering heat	IEC 115-1 IEC 68-2-20 10s at 260°C solder bath temperature	1 2 3	≤ ±0,04%
Robustness of terminations	IEC 115-1 4.16 IEC 68-2-21 tensile, bending and torsion	1 2 3	≤ ±0,01%

*) 1 ≙ NK3, NK4, NK5 tolerance 2% ... 5%
2 ≙ NY3, NY4, NY5 tolerance 0,5 ... 1%
3 ≙ N4, N5 tolerance 2% ... 5%.

Applicable Specifications

- CECC 40101-001/002/003/019
- MIL/UTE/DIN/BS CECC

- ESA-SCC 4001 001/002/005/007/009