

Home Products Quick Quote My Parts List Site Map Contact Us



## E1U Series Crystal

Quartz Crystal Resonator HC49/US Short Thru-Hole 2.5mm Height Metal Resistance Weld Seal



Revision G 11/09/2015

### Electrical Specifications

<b>Nominal Frequency</b>	3.579545MHz to 50.000MHz <i>Some frequencies within this range may not be available.</i>
<b>Frequency Tolerance (at 25°C)</b>	±50ppm Maximum ±30ppm Maximum ±15ppm Maximum ±10ppm Maximum
<b>Frequency Stability (over Operating Temperature Range)</b>	±100ppm Maximum ±50ppm Maximum ±30ppm Maximum ±20ppm Maximum ±15ppm Maximum
<b>Operating Temperature Range</b>	0°C to +70°C -20°C to +70°C -40°C to +85°C -40°C to +105°C -40°C to +125°C -55°C to +125°C
<b>Aging at 25°C</b>	±5ppm/year Maximum
<b>Load Capacitance</b>	10pF to 50pF Parallel Resonant Series Resonant
<b>Shunt Capacitance</b>	7pF Maximum
<b>Equivalent Series Resistance</b>	<a href="#">Click to Open ESR Table</a>
<b>Mode of Operation</b>	<a href="#">Fundamental or Third Overtone</a>
<b>Crystal Cut</b>	<a href="#">AT or BT</a>
<b>Drive Level</b>	1mWatt Maximum
<b>Storage Temperature Range</b>	-55°C to +125°C
<b>Insulation Resistance</b>	Measured at 100V <sub>DC</sub> 500 Megaohms Minimum

## Mechanical Dimensions

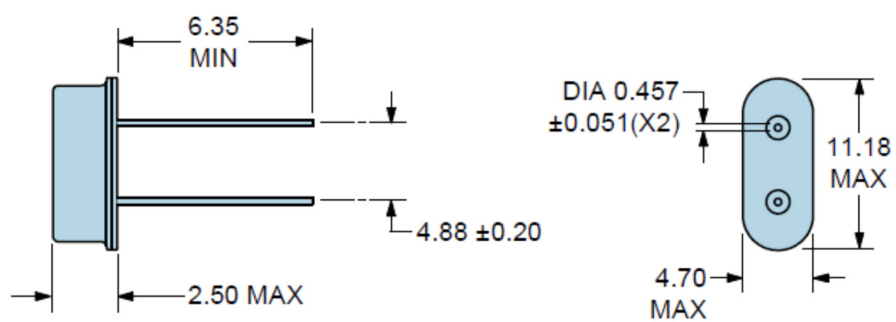

All Dimensions in Millimeters

## Marking Specifications

Line 1:

**XXXXXXM**

- E = Ecliptek Designator
- XXXXXX = Nominal Frequency (5 Digits + Decimal)
- M = Frequency Unit of Measure (MHz)

## Environmental and Mechanical Specifications

---

<b>ESD Susceptibility</b>	MIL-STD-883, Method 3015, Class 1, HBM: 1500V
<b>Fine Leak Test</b>	MIL-STD-883, Method 1014, Condition A
<b>Flammability</b>	UL94-V0
<b>Gross Leak Test</b>	MIL-STD-883, Method 1014, Condition C
<b>Lead Integrity</b>	MIL-STD-883, Method 2004
<b>Mechanical Shock</b>	MIL-STD-202, Method 213, Condition C
<b>Moisture Resistance</b>	MIL-STD-883, Method 1004
<b>Moisture Sensitivity</b>	J-STD-020, MSL1
<b>Resistance to Soldering Heat</b>	MIL-STD-202, Method 210, Condition K
<b>Resistance to Solvents</b>	MIL-STD-202, Method 215
<b>Solderability</b>	MIL-STD-883, Method 2003
<b>Temperature Cycling</b>	MIL-STD-883, Method 1010, Condition B
<b>Vibration</b>	MIL-STD-883, Method 2007, Condition A

### Tape & Reel Dimensions

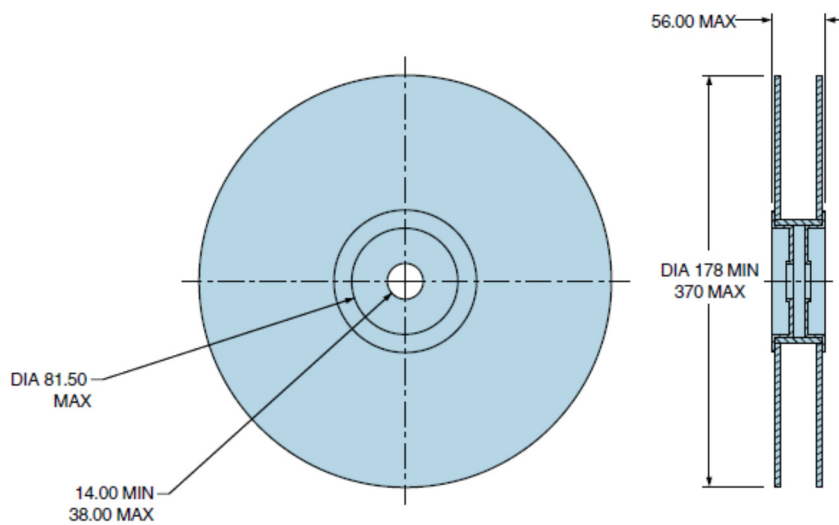
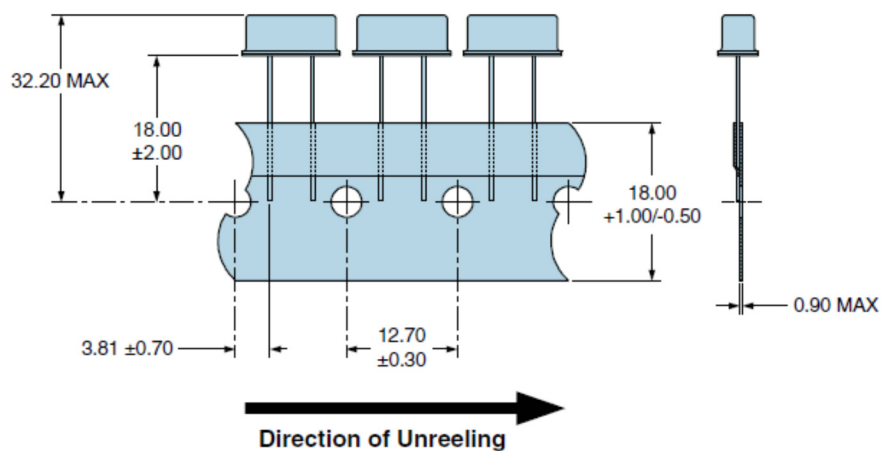

1000 pieces per reel  
Compliant to EIA-481  
All Dimensions in Millimeters

### Tape & Reel Dimensions (Variant 1)

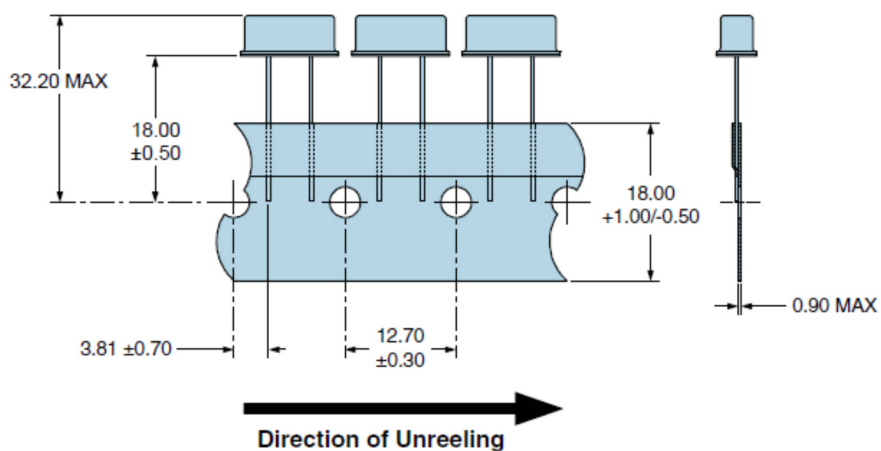

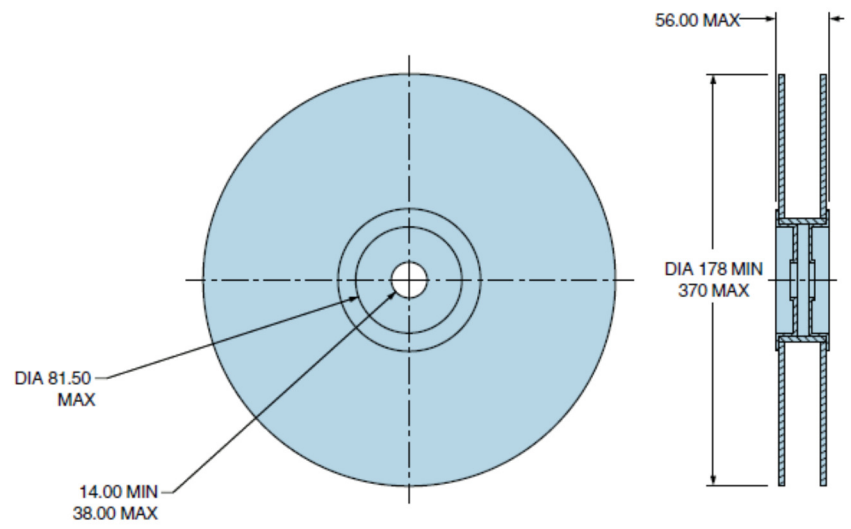

1000 pieces per reel  
Compliant to EIA-481  
All Dimensions in Millimeters

### Fundamental Mode AT Cut

<i>Nominal Frequency Range in MHz</i>	<i>Maximum ESR in Ohms</i>
3.579545 to 4.999999	200
5.000000 to 5.999999	150
6.000000 to 7.999999	120
8.000000 to 8.999999	90
9.000000 to 9.999999	80
10.000000 to 14.999999	70
15.000000 to 15.999999	60
16.000000 to 23.999999	50
24.000000 to 30.000000	40

### Fundamental Mode BT Cut

<i>Nominal Frequency Range in MHz</i>	<i>Maximum ESR in Ohms</i>
24.000000 to 40.000000	40

### Third Overtone Mode AT Cut

<i>Nominal Frequency Range in MHz</i>	<i>Maximum ESR in Ohms</i>
24.576000 to 29.999999	150
30.000000 to 50.000000	100

### Value Added Option - Custom Lead Length

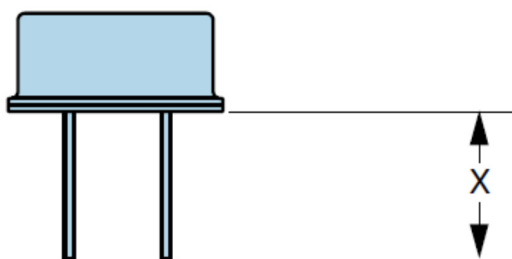

*X Dimension*

<i>Millimeters</i>	<i>Inches</i>	<i>Part Number Suffix</i>
2.540 ±0.500	0.100 ±0.020	CB
3.175 ±0.500	0.125 ±0.020	CC
3.810 ±0.500	0.150 ±0.020	CD
4.445 ±0.500	0.175 ±0.020	CE
5.080 ±0.500	0.200 ±0.020	CF
6.350 ±0.500	0.250 ±0.020	CG
6.985 ±0.500	0.275 ±0.020	CH
7.620 ±0.500	0.300 ±0.020	CJ
8.255 ±0.500	0.325 ±0.020	CL
8.890 ±0.500	0.350 ±0.020	CN
9.525 ±0.500	0.375 ±0.020	CP
10.16 ±0.500	0.400 ±0.020	CQ

### Value Added Option - Mylar Insulator Tab

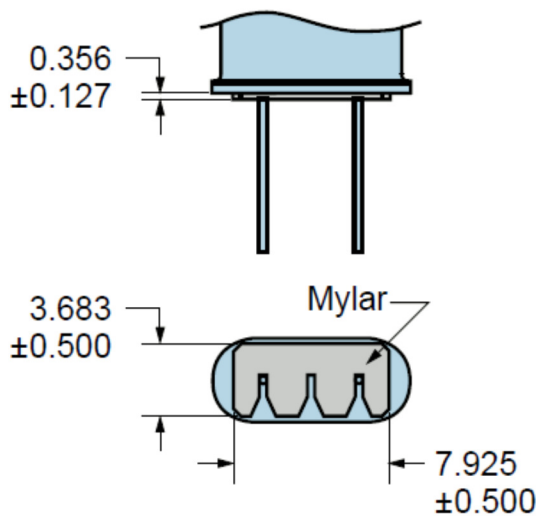

All Dimensions in Millimeters

## Solder Reflow Profile

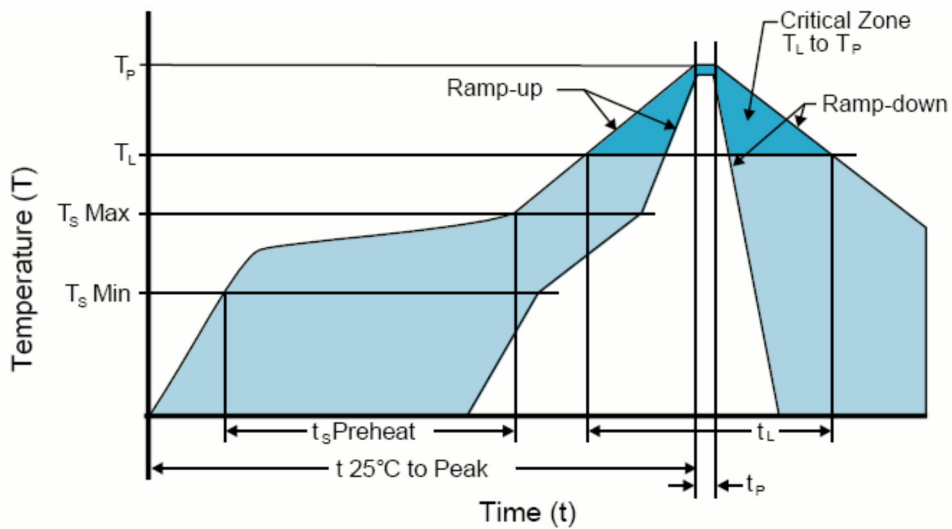

### High Temperature Solder Bath (Wave Solder)

**Note:** Temperatures shown are applied to back of PCB board and device leads only.

**$T_S$  MAX to  $T_L$  (Ramp-up Rate)** 3°C/second Maximum

#### Preheat

- Temperature Minimum ( $T_S$  MIN) 150°C
- Temperature Typical ( $T_S$  TYP) 175°C
- Temperature Maximum ( $T_S$  MAX) 200°C
- Time ( $t_s$ ) 60 - 180 Seconds

**Ramp-up Rate ( $T_L$  to  $T_P$ )** 3°C/second Maximum

#### Time Maintained Above:

- Temperature ( $T_L$ ) 217°C
- Time ( $t_L$ ) 60 - 150 Seconds

**Peak Temperature ( $T_P$ )** 260°C Maximum for 10 Seconds Maximum

**Target Peak Temperature ( $T_P$  Target)** 250°C +0/-5°C

**Time within 5°C of actual peak ( $t_p$ )** 20 - 40 seconds

**Ramp-down Rate** 6°C/second Maximum

**Time 25°C to Peak Temperature (t)** 8 minutes Maximum

**Moisture Sensitivity Level** Level 1



**Low Temperature Solder Bath (Wave Solder)**

**Note:** Temperatures shown are applied to back of PCB board and device leads only.

<b>T<sub>S</sub> MAX to T<sub>L</sub> (Ramp-up Rate)</b>	5°C/second Maximum
<b>Preheat</b>	
- Temperature Minimum (T <sub>S</sub> MIN)	N/A
- Temperature Typical (T <sub>S</sub> TYP)	150°C
- Temperature Maximum (T <sub>S</sub> MAX)	N/A
- Time (t <sub>S</sub> )	30 - 60 Seconds
<b>Ramp-up Rate (T<sub>L</sub> to T<sub>P</sub>)</b>	5°C/second Maximum
<b>Time Maintained Above:</b>	
- Temperature (T <sub>L</sub> )	150°C
- Time (t <sub>L</sub> )	200 Seconds Maximum
<b>Peak Temperature (T<sub>P</sub>)</b>	245°C Maximum
<b>Target Peak Temperature (T<sub>P</sub> Target)</b>	245°C Maximum 2 Times / 230°C Maximum 1 Time
<b>Time within 5°C of actual peak (t<sub>p</sub>)</b>	5 seconds Maximum 1 Time / 15 seconds Maximum 2 Times
<b>Ramp-down Rate</b>	5°C/second Maximum
<b>Time 25°C to Peak Temperature (t)</b>	N/A
<b>Moisture Sensitivity Level</b>	Level 1

**High Temperature Manual Soldering**

**Note:** Temperatures shown are applied to back of PCB board and device leads only. 260°C Maximum for 5 seconds Maximum, 2 times Maximum.

**Low Temperature Manual Soldering**

**Note:** Temperatures shown are applied to back of PCB board and device leads only. 185°C Maximum for 10 seconds Maximum, 2 times Maximum.

## Part Number Constructor

### Build a Part Number

Select the parameters that meet your requirements and then click the Next button below

### On the next page

Part Number specific documents, resources, and tools

#### Frequency (MHz)

3.579545 to 50.000

*Some frequencies within this range may not be available*

#### Frequency Tolerance/Stability

±50ppm at 25°C, ±100ppm over 0°C to +70°C

#### Mode of Operation

AT-Cut Fundamental

#### Load Capacitance (pF)

18 (10 to 50 or leave blank for Series Resonant)

#### Packaging Options

Bulk

#### Custom Lead Length

Standard Lead Length

#### Mylar Insulator Tab



Part Number Specific Data Sheet



Compliance Docs (REACH, RoHS, CMRT)



Automated Quick Quote



IPC-1752



Check Stock



My Parts List [?](#)



Plus more

## Part Numbering Guide

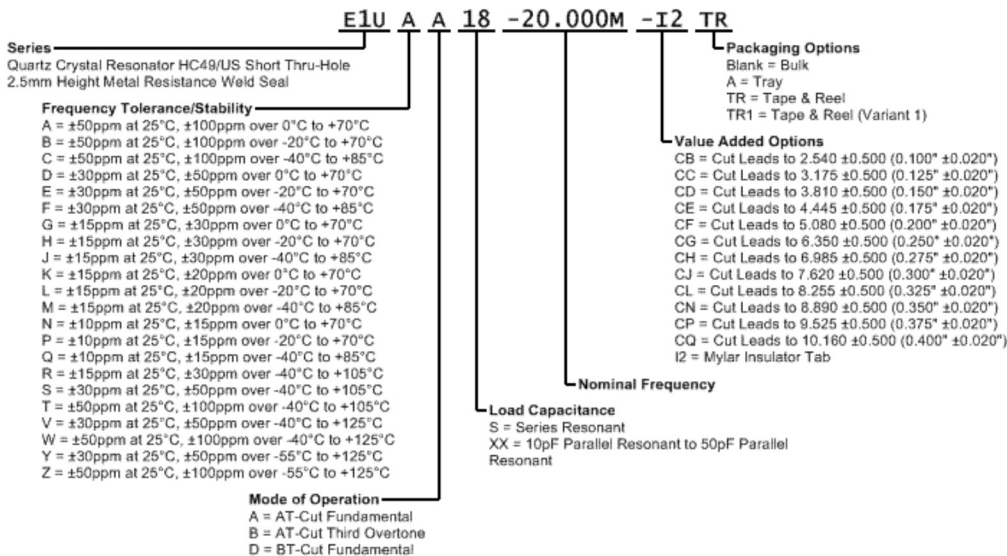



TOOLS

- [Quick Quote](#)
- [SmartSearch](#)
- [Compliance Documents](#)
- [Chipset Cross Reference](#)
- [Competitor Cross Reference](#)

PRODUCT

- [Crystals](#)
- [Oscillators](#)
- [Part Search](#)
- [REACH Resources](#)
- [RoHS Resources](#)
- [End of Life](#)

ECLIPTEK

- [Authorized Distributors](#)
- [Contact](#)
- [About](#)
- [News](#)
- [Our Quality](#)
- [ISO9001](#)
- [Feedback](#)

TERMS

- [Privacy Policy](#)
- [Terms of Sale](#)
- [Legal](#)