

DATA SHEET

TRANSIENT VOLTAGE SUPPRESSORS

AUTOMOTIVE GRADE

1.5KE-AT series

RoHS compliant & Halogen free



Product specification— April 29, 2019 V.0



Transient Voltage Suppressors (TVS) Data Sheet

Features

- Glass passivated junction
- Low zener impedance
- Excellent clamping capability
- 1500W peak pulse power capability at 10/1000 μ s waveform, repetition rate (duty cycle): 0.01%
- Fast response time
- Typical I_R less than 1 μ A above 12V.
- High Temperature soldering guaranteed: 265 $^{\circ}$ C/10 seconds/.375", (9.5mm) lead length, 5lbs (2.3kg) tension
- Plastic package has underwriters laboratory flammability 94V-0
- Meets MSL level 1, per J-STD-020.
- Safety certification: UL: E244458
- AEC-Q101 qualified



Mechanical Data

- Case: JEDEC DO-201 Moulded plastic
- Terminal: Axial leads, solderable per MIL-STD-750, Method 2026
- Polarity: Color band denotes cathode except bi-directional models
- Mounting Position: Any
- Weight: 0.97g

Applications

- I/O interface
- AC/DC power supply
- Low frequency signal transmission line (RS232, RS485, etc.)

Maximum Ratings and Characteristics

Ratings at 25 $^{\circ}$ C ambient temperature unless otherwise specified.

Rating	Symbol	Value	Units
Peak pulse power dissipation at 10/1000 μ s waveform (Note1, Fig.1)	P_{PPM}	Minimum 1500	Watts
Peak pulse current of at 10/1000 μ s waveform (Note 1, Fig.3)	I_{PPM}	See Table	Amps
Steady state power dissipation at $T_L=75^{\circ}$ C (Fig.5)	$P_{M(AV)}$	6.5	Watts
Peak forward surge current, 8.3ms single half sine-wave superimposed on rated load, (JEDEC Method) (Note2, Fig.6)	I_{FSM}	200	Amps
Operating junction and Storage Temperature Range.	T_J, T_{STG}	-55 to +150	$^{\circ}$ C
Typical thermal resistance junction to lead	$R_{\theta JL}$	15	$^{\circ}$ C/W
Typical thermal resistance junction to ambient	$R_{\theta JA}$	75	$^{\circ}$ C/W

Notes: 1. Non-repetitive current pulse, per Fig.3 and derated above $T_A=25^{\circ}$ C per Fig.2.

2. 8.3ms single half sine-wave, or equivalent square wave, duty cycle=4 pulses per minutes maximum.

Dimensions (DO-201)

	Symbol	Millimeters		Inches	
		Min.	Max.	Min.	Max.
L	25.40	-	1.000	-	
T	7.20	9.50	0.285	0.375	
d	4.80	5.30	0.190	0.210	
s	0.96	1.07	0.038	0.042	

Part Number Code

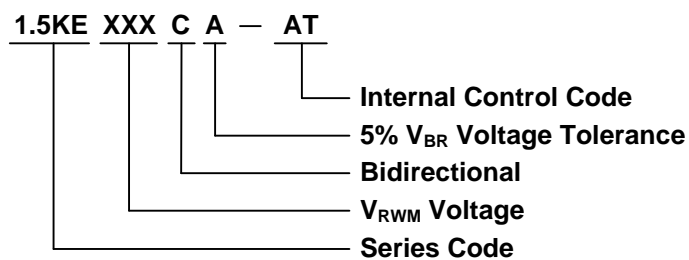

Ordering Code for different package

Box package: Add suffix “/B” at the end of the part number, such as 1.5KE100CA-AT/B

Reel package: Add suffix “/TR13” at the end of the part number, such as 1.5KE75A-AT/TR13

Electrical Characteristics ($T_A=25^\circ\text{C}$)

Part Number		Reverse Stand-Off Voltage	Breakdown Voltage @ I_T	Test Current	Maximum Clamping Voltage @ I_{PP}	Peak Pulse Current	Reverse Leakage @ V_{RWM}
Unidirectional	Bidirectional	$V_{RWM}(V)$	$V_{BR}(V)$	$I_T(mA)$	$V_C(V)$	$I_{PP}(A)$	$I_R(\mu A)$
1.5KE6.8A-AT	1.5KE6.8CA-AT	5.80	6.45~7.14	10	10.5	144.8	1000
1.5KE7.5A-AT	1.5KE7.5CA-AT	6.40	7.13~7.88	10	11.3	134.5	500
1.5KE8.2A-AT	1.5KE8.2CA-AT	7.02	7.79~8.61	10	12.1	125.6	200
1.5KE9.1A-AT	1.5KE9.1CA-AT	7.78	8.65~9.55	1	13.4	113.4	50
1.5KE10A-AT	1.5KE10CA-AT	8.55	9.50~10.50	1	14.5	104.8	10
1.5KE11A-AT	1.5KE11CA-AT	9.40	10.50~11.60	1	15.6	97.4	5
1.5KE12A-AT	1.5KE12CA-AT	10.20	11.40~12.60	1	16.7	91.0	5
1.5KE13A-AT	1.5KE13CA-AT	11.10	12.40~13.70	1	18.2	83.5	1
1.5KE15A-AT	1.5KE15CA-AT	12.80	14.30~15.80	1	21.2	71.7	1
1.5KE16A-AT	1.5KE16CA-AT	13.60	15.20~16.80	1	22.5	67.6	1
1.5KE18A-AT	1.5KE18CA-AT	15.30	17.10~18.90	1	25.2	60.3	1

Transient Voltage Suppressors 1.5KE-AT

Electrical Characteristics ($T_A=25^\circ\text{C}$)

Part Number		Reverse Stand-Off Voltage	Breakdown Voltage @ I_T	Test Current	Maximum Clamping Voltage @ I_{PP}	Peak Pulse Current	Reverse Leakage @ V_{RWM}
Unidirectional	Bidirectional	$V_{RWM}(V)$	$V_{BR}(V)$	$I_T(mA)$	$V_C(V)$	$I_{PP}(A)$	$I_R(\mu A)$
1.5KE20A-AT	1.5KE20CA-AT	17.10	19.00~21.00	1	27.7	54.9	1
1.5KE22A-AT	1.5KE22CA-AT	18.80	20.90~23.10	1	30.6	49.7	1
1.5KE24A-AT	1.5KE24CA-AT	20.50	22.80~25.20	1	33.2	45.8	1
1.5KE27A-AT	1.5KE27CA-AT	23.10	25.70~28.40	1	37.5	40.5	1
1.5KE30A-AT	1.5KE30CA-AT	25.60	28.50~31.50	1	41.4	36.7	1
1.5KE33A-AT	1.5KE33CA-AT	28.20	31.40~34.70	1	45.7	33.3	1
1.5KE36A-AT	1.5KE36CA-AT	30.80	34.20~37.80	1	49.9	30.5	1
1.5KE39A-AT	1.5KE39CA-AT	33.30	37.10~41.00	1	53.9	28.2	1

Electrical Characteristics ($T_A=25^\circ\text{C}$)

Part Number		Reverse Stand-Off Voltage	Breakdown Voltage @ I_T	Test Current	Maximum Clamping Voltage @ I_{PP}	Peak Pulse Current	Reverse Leakage @ V_{RWM}
Unidirectional	Bidirectional	$V_{RWM}(V)$	$V_{BR}(V)$	$I_T(mA)$	$V_C(V)$	$I_{PP}(A)$	$I_R(\mu A)$
1.5KE43A-AT	1.5KE43CA-AT	36.80	40.90~45.20	1	59.3	25.6	1
1.5KE47A-AT	1.5KE47CA-AT	40.20	44.70~49.40	1	64.8	23.5	1
1.5KE51A-AT	1.5KE51CA-AT	43.60	48.50~53.60	1	70.1	21.7	1
1.5KE56A-AT	1.5KE56CA-AT	47.80	53.20~58.80	1	77.0	19.7	1
1.5KE62A-AT	1.5KE62CA-AT	53.00	58.90~65.10	1	85.0	17.9	1
1.5KE68A-AT	1.5KE68CA-AT	58.10	64.60~71.40	1	92.0	16.5	1
1.5KE75A-AT	1.5KE75CA-AT	64.10	71.30~78.80	1	103.0	14.8	1
1.5KE82A-AT	1.5KE82CA-AT	70.10	77.90~86.10	1	113.0	13.5	1
1.5KE91A-AT	1.5KE91CA-AT	77.80	86.50~95.50	1	125.0	12.2	1
1.5KE100A-AT	1.5KE100CA-AT	85.50	95.00~105.00	1	137.0	11.1	1
1.5KE110A-AT	1.5KE110CA-AT	94.00	105.00~116.00	1	152.0	10.0	1
1.5KE120A-AT	1.5KE120CA-AT	102.00	114.00~126.00	1	165.0	9.2	1
1.5KE130A-AT	1.5KE130CA-AT	111.00	124.00~137.00	1	179.0	8.5	1
1.5KE150A-AT	1.5KE150CA-AT	128.00	143.00~158.00	1	207.0	7.3	1
1.5KE160A-AT	1.5KE160CA-AT	136.00	152.00~168.00	1	219.0	6.9	1
1.5KE170A-AT	1.5KE170CA-AT	145.00	162.00~179.00	1	234.0	6.5	1

Transient Voltage Suppressors | 1.5KE-AT

Part Number		Reverse Stand-Off Voltage	Breakdown Voltage @ I_T	Test Current	Maximum Clamping Voltage @ I_{PP}	Peak Pulse Current	Reverse Leakage @ V_{RWM}
Unidirectional	Bidirectional	$V_{RWM}(V)$	$V_{BR}(V)$	$I_T(mA)$	$V_C(V)$	$I_{PP}(A)$	$I_R(\mu A)$
1.5KE180A-AT	1.5KE180CA-AT	154.00	171.00~189.00	1	246.0	6.2	1
1.5KE200A-AT	1.5KE200CA-AT	171.00	190.00~210.00	1	274.0	5.5	1
1.5KE220A-AT	1.5KE220CA-AT	185.00	209.00~231.00	1	328.0	4.6	1
1.5KE250A-AT	1.5KE250CA-AT	214.00	237.00~263.00	1	344.0	4.4	1
1.5KE300A-AT	1.5KE300CA-AT	256.00	285.00~315.00	1	414.0	3.7	1
1.5KE350A-AT	1.5KE350CA-AT	300.00	332.00~368.00	1	482.0	3.2	1
1.5KE400A-AT	1.5KE400CA-AT	342.00	380.00~420.00	1	548.0	2.8	1
1.5KE440A-AT	1.5KE440CA-AT	376.00	418.00~462.00	1	602.0	2.5	1
1.5KE480A-AT	1.5KE480CA-AT	408.00	456.00~504.00	1	658.0	2.3	1
1.5KE510A-AT	1.5KE510CA-AT	434.00	485.00~535.00	1	698.0	2.1	1
1.5KE530A-AT	1.5KE530CA-AT	450.00	503.50~556.50	1	725.0	2.1	1
1.5KE540A-AT	1.5KE540CA-AT	459.00	513.00~567.00	1	740.0	2.0	1
1.5KE550A-AT	1.5KE550CA-AT	467.00	522.50~577.50	1	760.0	2.0	1

Notes: ① Specific code by request.

Ratings and Characteristic Curves ($T_A=25^\circ\text{C}$ unless otherwise noted)

Figure 1. Peak Pulse Power Rating Curve

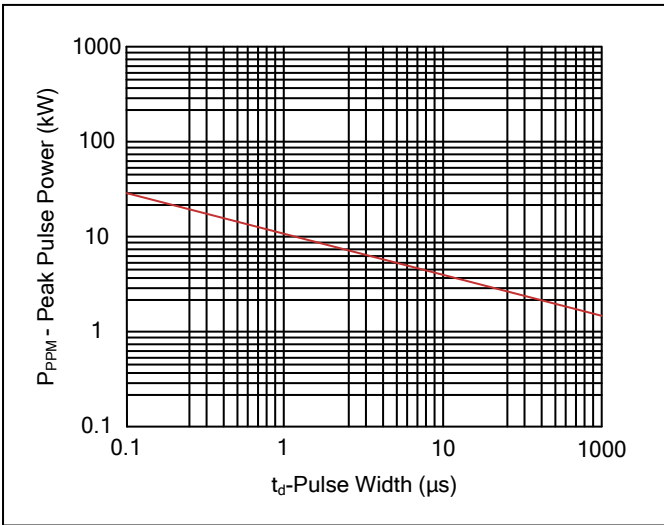

Figure 2. Pulse Derating Curve

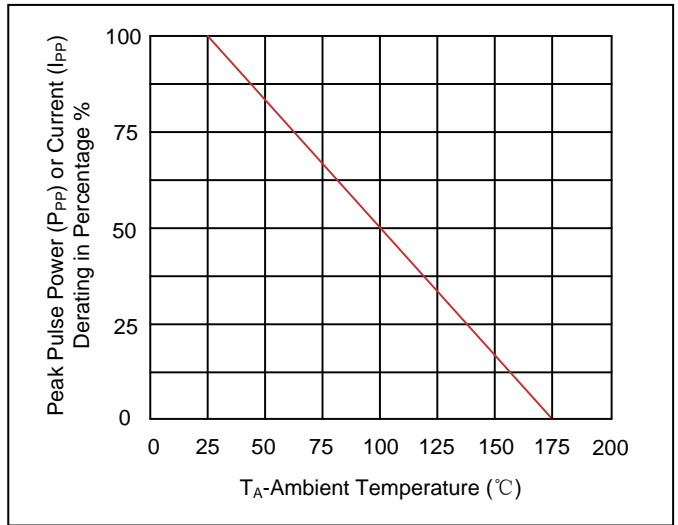

Figure 3. Pulse Waveform

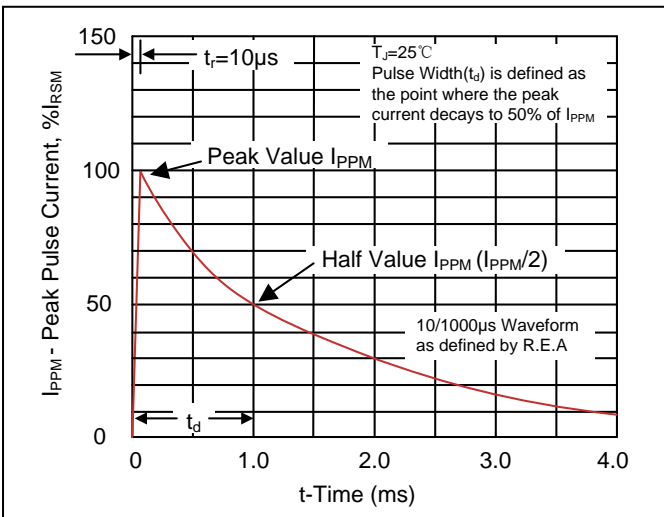

Figure 4. Typical Junction Capacitance

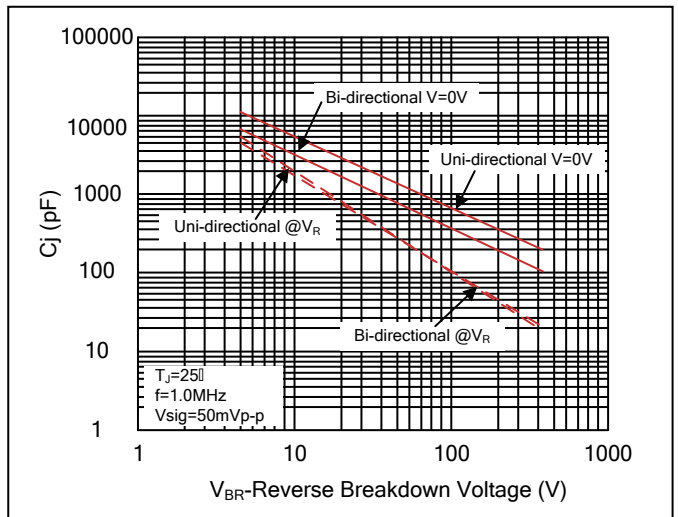

Figure 5. Steady State Power Dissipation Derating Curve

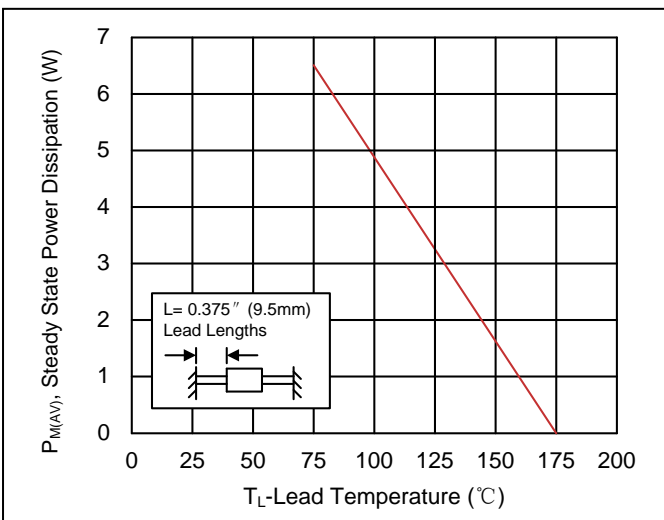
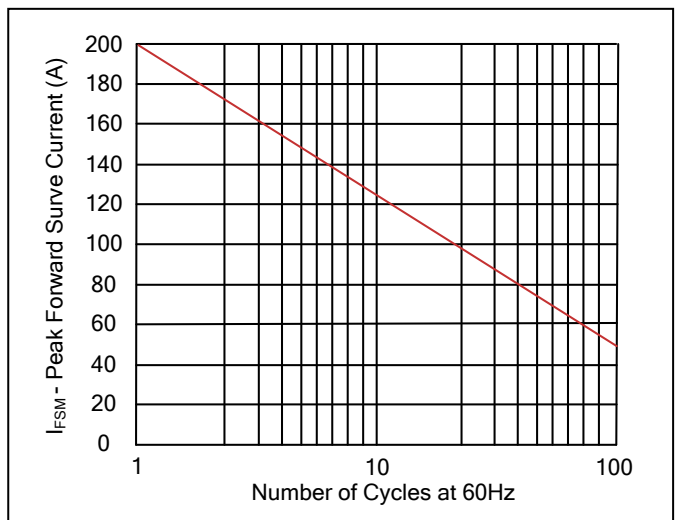
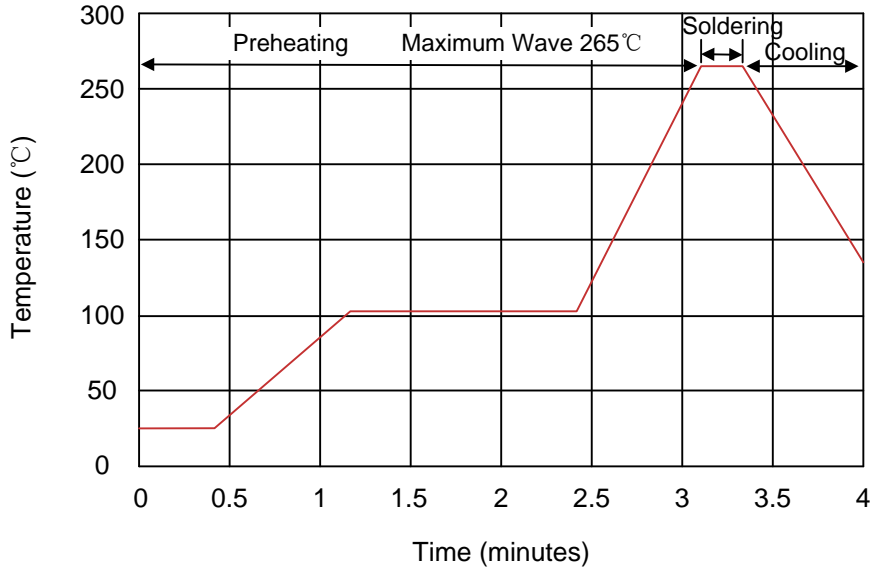

Figure 6. Maximum Non-Repetitive Forward Surge Current Uni-Directional Only



Recommended Soldering Conditions

Wave Soldering



Item	Conditions
Peak Temperature	265°C
Dipping Time	10 seconds
Soldering	1 time

Marking Code

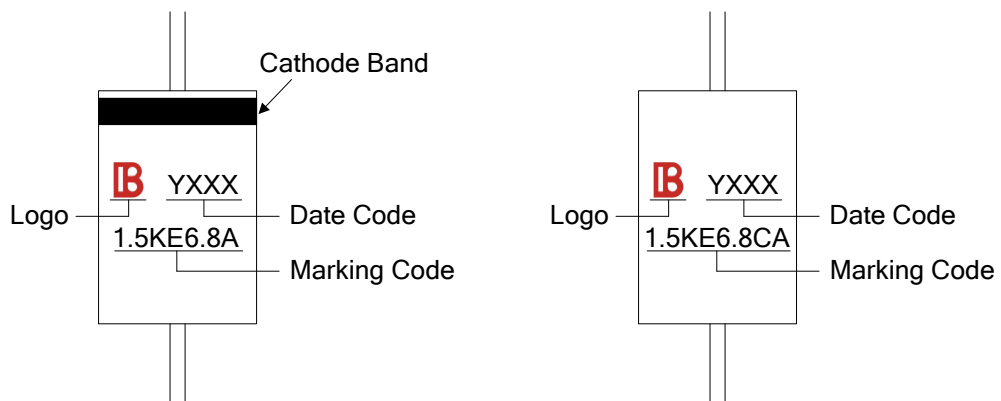

Packaging

Tape	Symbol	Dimension (mm)
	A	10.0±0.5
	B	53.0±1.0
	Z	1.2Max.
	T	6.0±0.4
	E	0.8Max.
	L1-L2	1.0Max.
	<p>Box</p>	L
W		75.0±5.0
H		114.0±5.0
Quantity: 1000PCS		
<p>Reel</p>	D	330.0±3.0
	D0	16.4±2.0
	D1	86.0±2.0
	W1	76.0±3.0
	Quantity: 1200PCS	