

NAIS

2 Form A slim power relay

LA RELAYS

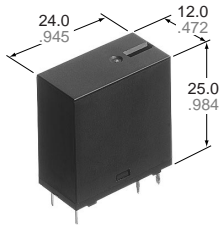

mm inch

FEATURES

1. 2 Form A slim type

24(L) × 12(W) × 25(H) mm
.945(L) × .472(W) × .984(H) inch

2. 3A type and 5A TV type

3A type: Contact reliability and break performance best suited for protecting and switching speakers.

5A TV type: Tough against inrush current and optimal for turning on and off the power supply. Rated TV-4 (UL/CSA).

3. High insulation resistance

• Creepage distance and clearances between contact and coil: Min. 6 mm .236 inch (In compliance with IEC65)

• Surge withstand voltage between contact and coil: 10,000 V or more.

4. High noise immunity realized by the card separation structure between contact and coil

5. Conforms to the various safety standards

• UL/CSA, VDE, TÜV, SEMKO, SEV approved

SPECIFICATIONS

Contact

Type	3A rated	5A TV rated	
Arrangement	2 Form A		
Initial contact resistance, max. (By voltage drop 6 V DC 1 A)	Max. 50 mΩ	Max. 100 mΩ	
Contact material	Gold-clad silver alloy	Silver alloy	
Rating (resistive load)	Nominal switching capacity	3 A 125 V AC	5 A 277 V AC
	Max. switching power	625 VA	1,385 V A
	Max. switching voltage	125 V AC	277 V AC
	Max. switching current	5 A (AC)	
Expected life (min. operations)	Mechanical (at 180 cpm)	10 ⁶	
	Electrical (at 20 cpm) (at rated load)	5 × 10 ⁴ (ON: OFF=1.5s: 1.5s)	

Coil

Nominal operating power	530 mW
-------------------------	--------

Remarks

- * Specifications will vary with foreign standards certification ratings.
- *1 Measurement at same location as "Initial breakdown voltage" section.
- *2 Detection current: 10mA
- *3 Wave is standard shock voltage of ±1.2 × 50ms according to JEC-212-1981
- *4 Excluding contact bounce time.
- *5 Half-wave pulse of sine wave: 11 ms; detection time: 10 μs
- *6 Half-wave pulse of sine wave: 6 ms
- *7 Detection time: 10 μs
- *8 Refer to 5. Conditions for operation, transport and storage mentioned in AMBIENT ENVIRONMENT (Page 61).

Characteristics

Type	3A rated	5A TV rated	
Max. operating speed	20 cpm		
Initial insulation resistance*1	Min. 1,000 MΩ (at 500 V DC)		
Initial *2 breakdown voltage	Between contact sets	1,000 Vrms for 1 min.	
	Between open contacts	1,000 Vrms for 1 min.	
	Between contact and coil	4,000 Vrms for 1 min.	
Surge voltage between contact and coil*3	Min. 10,000 V		
Operate time*4 (at nominal voltage)	Max. 15ms (at 20°C 68°F)		
Release time (with diode)*4 (at nominal voltage)	Max. 15ms (at 20°C 68°F)		
Temperature rise (at 70°C)	Max. 45°C with nominal coil voltage and at 3 A contact carrying current	Max. 45°C with nominal coil voltage and at 5 A contact carrying current	
	Shock resistance	Functional*5	Min. 200 m/s ² {approx. 20 G}
Vibration resistance	Destructive*6	Min. 1,000 m/s ² {approx. 100 G}	
	Functional*7	10 to 55Hz at double amplitude of 1.5mm	
Destructive		10 to 55Hz at double amplitude of 1.5mm	
	Conditions for operation, transport and storage*8 (Not freezing and condensing at low temperature)	Ambient temp.	-40°C to +70°C -40°F to +158°F
Humidity		5 to 85% R.H.	
Air pressure		86 to 106 kPa	
Unit weight	Approx. 13 g .46 oz		

ORDERING INFORMATION

Ex. A LA 2 P F 12

Product name	Contact arrangement	Contact capacity	Protective construction	Coil voltage(V DC)
LA	2: 2 Form A	Nil: 3A P: 5A TV-4	F: Flux-resistant type	12, 24

UL/CSA, VDE, TÜV, SEMKO, TV-4 approved type is standard.

Notes: 1. Standard packing Carton: 100 pcs. Case: 500 pcs.

2. 4.5V, 5V, 9V and 18V DC types are also available. Please consult us for details.

TYPES AND COIL DATA (at 20°C 68°F)

Part No.		Nominal voltage, V DC	Pick-up voltage, V DC (max.)	Drop-out voltage, V DC (min.)	Coil resistance, Ω (±10%)	Nominal operating current, mA (±10%)	Nominal operating power, mW	Maximum allowable voltage, V DC
3 A type	5A TV type							
ALA2F12	ALA2PF12	12	(Initial) 9	(Initial) 0.6	272	44.2	530	15.6
ALA2F24	ALA2PF24	24	(Initial) 18	(Initial) 1.2	1,087	22.1	530	31.2

DIMENSIONS

mm inch

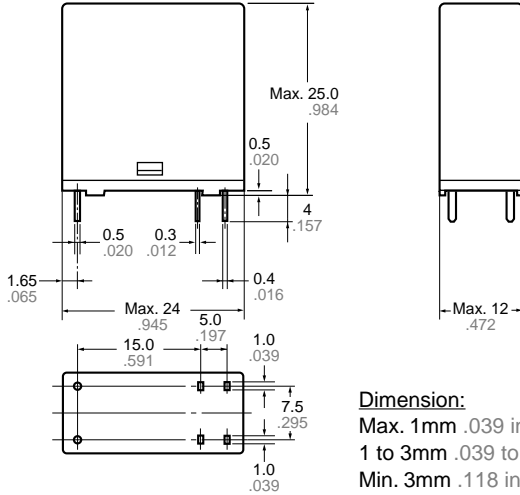

PC board pattern (Bottom view)

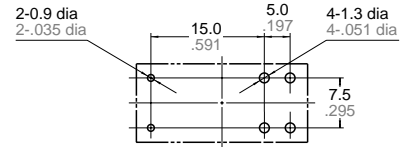

Tolerance : ±0.1 ±.004

Schematic (Bottom view)



Dimension:
 Max. 1mm .039 inch:
 1 to 3mm .039 to .118 inch:
 Min. 3mm .118 inch:

General tolerance
 ±0.1 ±.004
 ±0.2 ±.008
 ±0.3 ±.012

REFERENCE DATA

1. Max. switching power (AC resistive load)

2-(1). Life curve (250 V AC resistive load)

2-(2). Life curve (125 V AC resistive load)

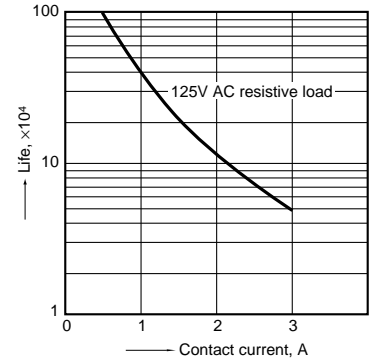
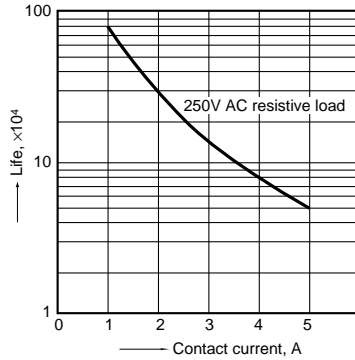
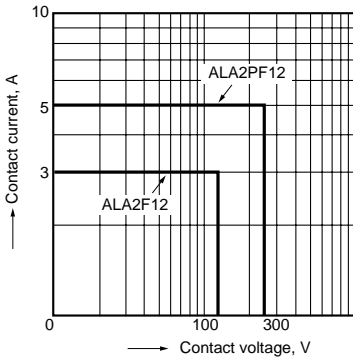

3-(1). Coil temperature rise

Sample: ALA2F12, 6 pcs.
 Measured portion: coil inside
 Contact current: 0 A, 3A

3-(2). Coil temperature rise

Sample: ALA2PF12, 6 pcs.
 Measured portion: coil inside
 Contact current: 0 A, 5A

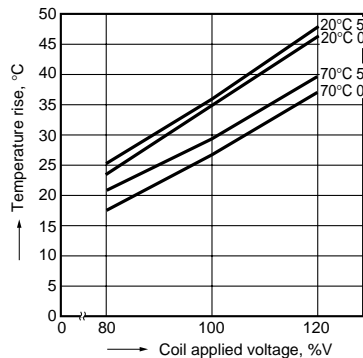
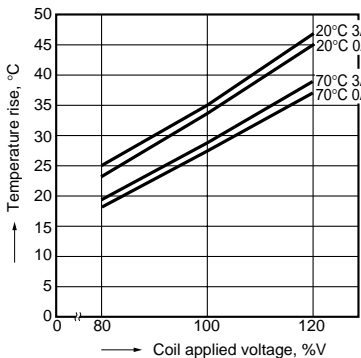

4. Ambient temperature characteristics and coil applied voltage

Contact current: ALA2F=3A
 ALA2PF=5A

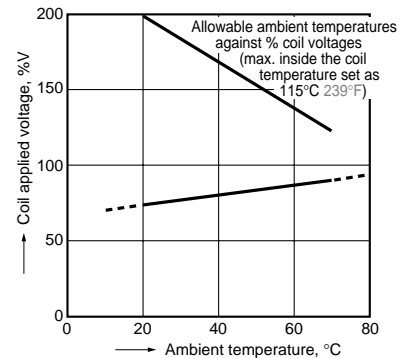

5-(1). Electrical life test
 (3 A 125 V AC, resistive load)
 Sample: ALA2F12, 6 pcs.
 Operation frequency: 20 times/min.
 (ON/OFF = 1.5s: 1.5s)
 Ambient temperature: 20°C 68°F

Circuit:

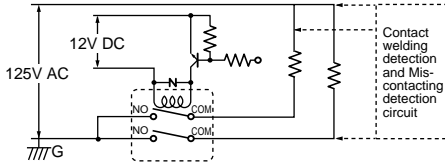

Change of pick-up and drop-out voltage

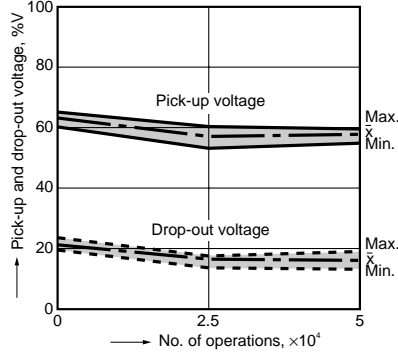

Change of contact resistance

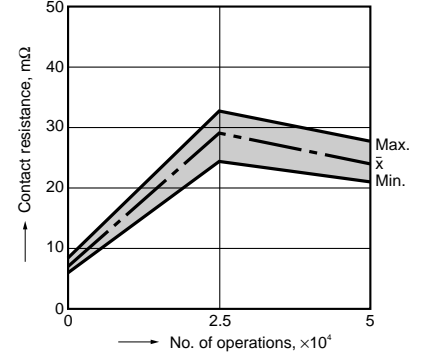

5-(2). Electrical life test
 (5 A 250 V AC, resistive load)
 Sample: ALA2PF12, 6 pcs.
 Operation frequency: 20 times/min.
 (ON/OFF = 1.5s: 1.5s)
 Ambient temperature: 20°C 68°F

Circuit:

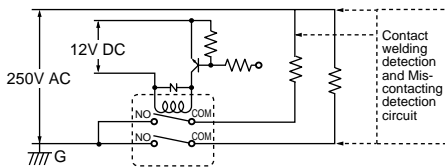

Change of pick-up and drop-out voltage

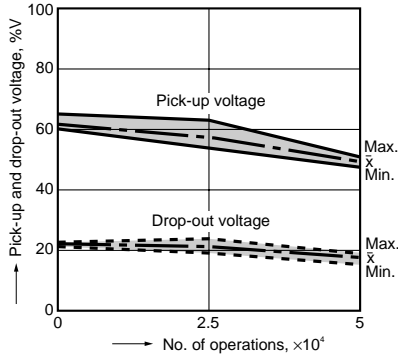

Change of contact resistance

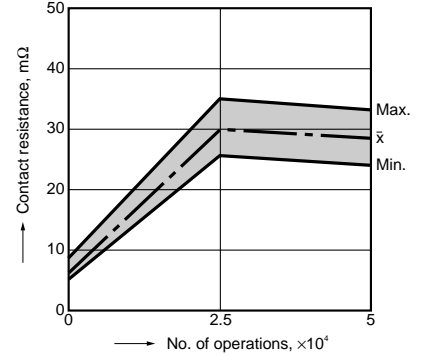

5-(3). Electrical life test
 (UL lamp load test TV-4)

- Tested sample: ALA2PF12, 6 pcs.
- Overload test
 Load: 6.0 A 120 V AC (60 Hz),
 Inrush: 91 A
 Operation frequency: 10 times/min
 (ON: OFF = 1 s: 5 s)
 No. of operations: 50 ope.
 - Endurance test
 Load: 4A 120 V AC (60 Hz),
 Inrush: 65 A
 Operation frequency: 10 times/min
 (ON: OFF = 1 s: 5 s)
 No. of operations: 25,000 ope.

Change of pick-up and drop-out voltage

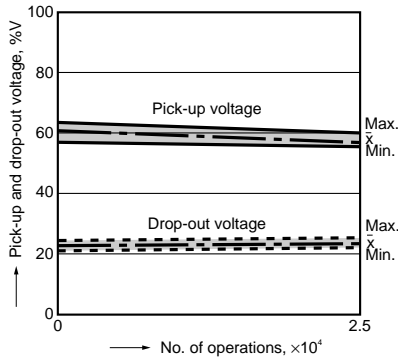

Change of contact resistance

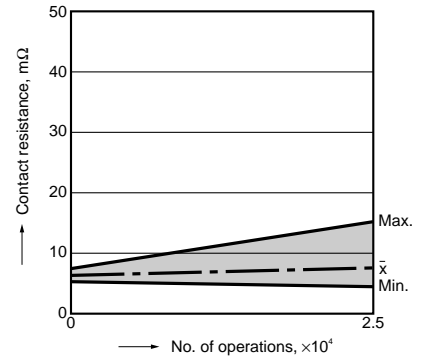

For Cautions for Use, see Relay Technical Information (Page 48 to 76).