

CA3018, CA3018A

General-Purpose Transistor Arrays

Two Isolated Transistors and
a Darlington-Connected Transistor Pair
For Low-Power Applications at Frequencies
from DC Through the VHF Range

Features:

- Matched monolithic general purpose transistors
- H_{FE} matched $\pm 10\%$
- V_{BE} matched ± 2 mV CA3018A (± 5 mV CA3018)
- Operation from DC to 120 MHz
- Wide operating current range
- CA3018A performance characteristics controlled from 10 μ A to 10 mA
- Low noise figure - 3.2 dB typical at 1KHz
- Full military temperature range capability (-55 to +125° C)

The CA3018 and CA3018A consist of four general purpose silicon n-p-n transistors on a common monolithic substrate.

Two of the four transistors are connected in the Darlington configuration. The substrate is connected to a separate terminal for maximum flexibility.

The transistors of the CA3018 and the CA3018A are well suited to a wide variety of applications in low-power systems in the DC through VHF range. They may be used as discrete transistors in conventional circuits but in addition they provide the advantages of close electrical and thermal matching inherent in integrated circuit construction.

The CA3018A is similar to the CA3018 but features tighter control of current gain, leakage, and offset parameters making it suitable for more critical applications requiring premium performance.

Applications

- General use in signal processing systems in DC through VHF range
- Custom designed differential amplifiers
- Temperature compensated amplifiers
- See RCA Application Note, ICAN-5296 "Application of the RCA CA3018 Integrated-Circuit Transistor Array" for suggested applications.

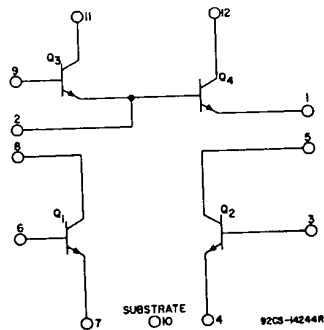

Fig. 1 — Schematic Diagram for CA3018 and CA3018A

CA3018, CA3018A

T'43-25

Maximum Ratings, Absolute-Maximum Values, at TA=25°C

	CA3018	CA3018A	
Power Dissipation, P:			
Any one transistor	300	300	mW
Total package	450	450	mW

Derate at 5 mW/°C for TA > 85°C

Temperature Range:

Operating	-55 to +125	-55 to +125°C
Storage	-65 to +150	-65 to +150°C

The following ratings apply for each transistor in the device:

	CA3018	CA3018A	
Collector-to-Emitter Voltage, V _{CEO}	15	15	V
Collector-to-Base Voltage, V _{CBO}	20	30	V
Collector-to-Substrate Voltage, V _{CIO} *	20	40	V
Emitter-to-Base Voltage, V _{EBO}	5	5	V
Collector Current, I _C	50	50	mA

*The collector of each transistor of the CA3018 and CA3018A is isolated from the substrate by an integral diode. The substrate (terminal 10) must be connected to the most negative point in the external circuit to maintain isolation between transistors and to provide for normal transistor action.

LEAD TEMPERATURE (During Soldering)

At distance 1/16 ± 1/32 inch (1.59 ± 0.79mm)

from case for 10 seconds max. +265°C

Characteristics apply for each transistor in the CA3018 and CA3018A as specified.

ELECTRICAL CHARACTERISTICS at TA = 25°C	SYMBOLS	SPECIAL TEST CONDITIONS	CA3018 LIMITS			CA3018A LIMITS			Units	CHARACTERISTICS CURVES	
			Min.	Typ.	Max.	Min.	Typ.	Max.			
STATIC CHARACTERISTICS											
Collector-Cutoff Current	I _{CBO}	V _{CB} =10V, I _E =0	-	0.002	100	-	0.002	40	nA	2	
Collector-Cutoff Current	I _{CEO}	V _{CE} =10V, I _B =0	-	See Curve	5	-	See Curve	0.5	μA	3	
Collector-Cutoff Current Darlington Pair	I _{CEOD}	V _{CE} =10V, I _B =0	-	-	-	-	-	5	μA	-	
Collector-to-Emitter Breakdown Voltage	V _{(BR)CEO}	I _C =1mA, I _B =0	15	24	-	15	24	-	V	-	
Collector-to-Base Breakdown Voltage	V _{(BR)CBO}	I _C =10μA, I _E =0	20	60	-	30	60	-	V	-	
Emitter-to-Base Breakdown Voltage	V _{(BR)EBO}	I _E =10μA, I _C =0	5	7	-	5	7	-	V	-	
Collector-to-Substrate Breakdown Voltage	V _{(BR)CIO}	I _C =10μA, I _{C1} =0	20	60	-	40	60	-	V	-	
Collector-to-Emitter Saturation Voltage	V _{CES}	I _B =1mA, I _C =10mA	-	0.23	-	-	0.23	0.5	V	-	
Static Forward Current Transfer Ratio	h _{FE}	V _{CE} =3V, { I _C =10mA I _C =1mA I _C =10μA	-	100	-	50	100	-	-	4	
Magnitude of Static-Beta Ratio (Isolated Transistors Q ₁ and Q ₂)		V _{CE} =3V, I _{C1} =I _{C2} =1mA	0.9	0.97	-	0.9	0.97	-	-	4	
Static Forward Current Transfer Ratio Darlington Pair (Q ₃ & Q ₄)	h _{FED}	V _{CE} =3V, { I _C =1mA I _C =100μA	1500	5400	-	2000	5400	-	-	5	
Base-to-Emitter Voltage	V _{BE}	V _{CE} =3V, { I _E =1mA I _E =10mA	-	0.715	-	0.600	0.715	0.800	0.900	V	6
Input Offset Voltage	$\frac{V_{BE1} - V_{BE2}}{2}$	V _{CE} =3V, I _E =1mA	-	0.48	5	-	0.48	2	mV	6,8	
Temperature Coefficient: Base-to-Emitter Voltage Q ₁ , Q ₂	$\frac{\Delta V_{BE}}{\Delta T}$	V _{CE} =3V, I _E =1mA	-	-1.9	-	-	-1.9	-	mV/°C	7	
Base (Q ₃) to-Emitter (Q ₄) Voltage-Darlington Pair	V _{BED} (V _{g-1})	V _{CE} =3V, { I _E =10mA I _E =1mA	-	1.46	-	-	1.46	1.60	1.50	V	9
Temperature Coefficient: Base-to-Emitter Voltage Darlington Pair-Q ₃ , Q ₄	$\frac{\Delta V_{BED}}{\Delta T}$	V _{CE} =3V, I _E =1mA	-	4.4	-	-	4.4	-	mV/°C	10	
Temperature Coefficient: Magnitude of Input-Offset Voltage	$\frac{V_{BE1} - V_{BE2}}{\Delta T}$	V _{CC} =+6V, V _{EE} =-6V, I _{C1} =I _{C2} =1mA	-	10	-	-	10	-	μV/°C	-	

CA3018, CA3018A

T-43-25

ELECTRICAL CHARACTERISTICS, (CONT'D)

DYNAMIC CHARACTERISTICS										
Low Frequency Noise Figure	NF	f=1 KHz, V _{CE} =3V, I _C =100μA Source resistance=1 KΩ	-	3.25	-	-	3.25	-	dB	11(b)
Low-Frequency, Small-Signal Equivalent-Circuit Characteristics:										
Forward Current-Transfer Ratio	h _{fe}	f=1kHz, V _{CE} =3V, I _C =1mA	-	110	-	-	110	-	-	12
Short-Circuit Input Impedance	h _{ie}		-	3.5	-	-	3.5	-	KΩ	12
Open-Circuit Output Impedance	h _{oe}		-	15.6	-	-	15.6	-	μho	12
Open-Circuit Reverse Voltage-Transfer Ratio	h _{re}		-	1.8x10 ⁻⁴	-	-	1.8x10 ⁻⁴	-	-	12
Admittance Characteristics:										
Forward Transfer Admittance	Y _{fe}	f=1MHz, V _{CE} =3V, I _C =1mA	-	31-j1.5	-	-	31-j1.5	-	mmho	13
Input Admittance	Y _{ie}		-	0.3+j0.04	-	-	0.3+j0.04	-	mmho	14
Output Admittance	Y _{oe}		-	0.001+j0.03	-	-	0.001+j0.03	-	mmho	15
Reverse Transfer Admittance	Y _{re}		See Curve		See Curve		See Curve		mmho	16
Gain-Bandwidth Product	f _T	V _{CE} =3V, I _C =3mA	300	500	-	300	500	-	MHz	17
Emitter-to-Base Capacitance	C _{EB}	V _{EB} =3V, I _E =0	-	0.6	-	-	0.6	-	pF	-
Collector-to-Base Capacitance	C _{CB}	V _{CB} =3V, I _C =0	-	0.58	-	-	0.58	-	pF	-
Collector-to-Substrate Capacitance	C _{CI}	V _{CI} =3V, I _C =0	-	2.8	-	-	2.8	-	pF	-

STATIC CHARACTERISTICS

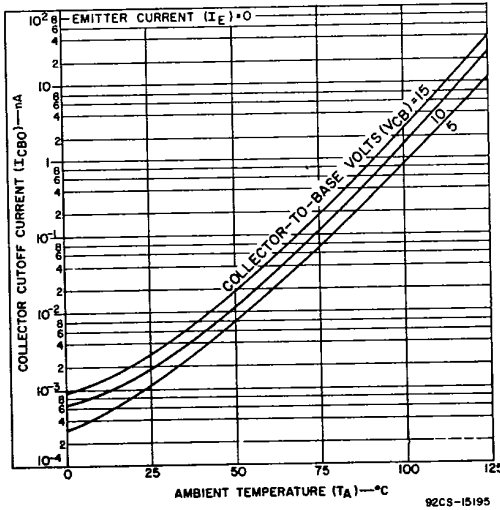

Fig. 2 - Typical Collector-To-Base Cutoff Current vs Ambient Temperature for Each Transistor.

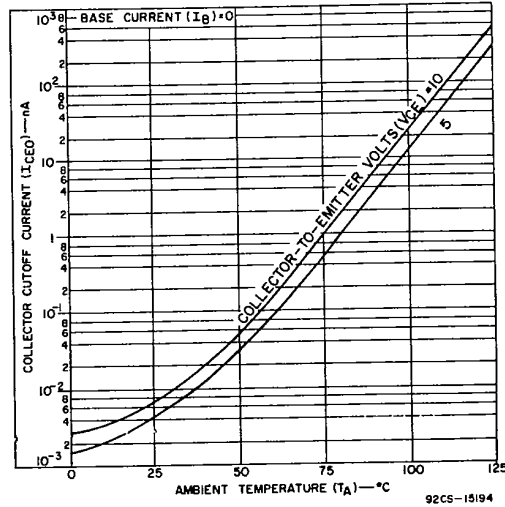

Fig. 3 - Typical Collector-To-Emmitter Cutoff Current vs Ambient Temperature for Each Transistor.

CA3018, CA3018A

T-43-25

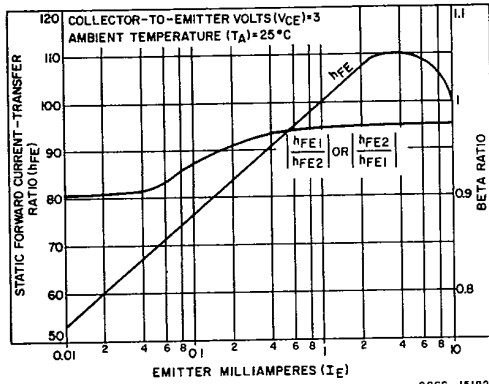

Fig. 4 - Typical Static Forward Current-Transfer Ratio and Beta Ratio for Transistors Q_1 and Q_2 vs Emitter Current.

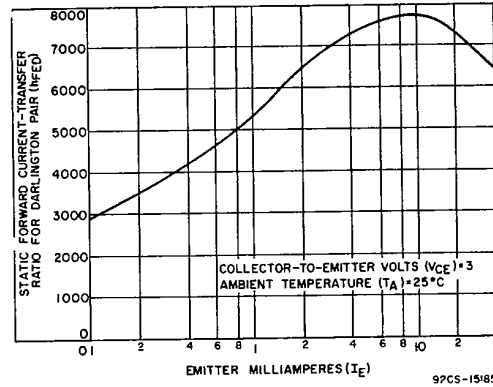

Fig. 5 - Typical Static Forward Current-Transfer Ratio for Darlingtons-connected Transistors Q_3 and Q_4 vs Emitter Current.

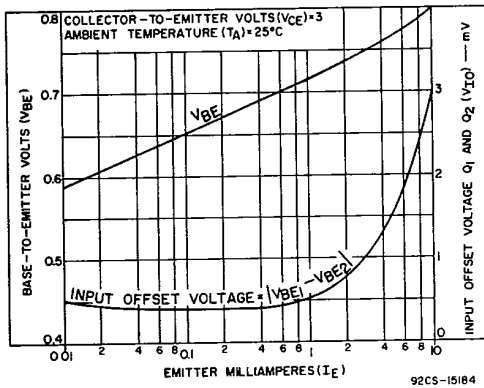

Fig. 6 - Typical Static Base-to-Emitter Voltage Characteristic and Input Offset Voltage for Q_1 and Q_2 vs Emitter Current.

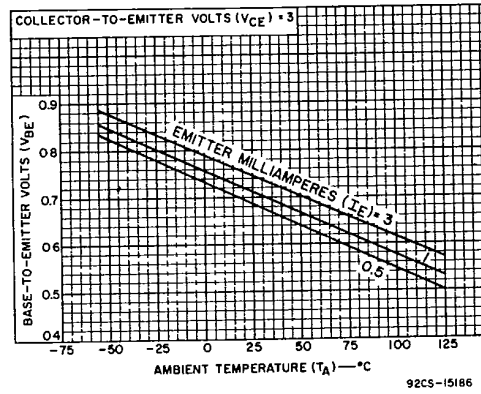

Fig. 7 - Typical Base-to-Emitter Voltage Characteristic for Each Transistor vs Ambient Temperature

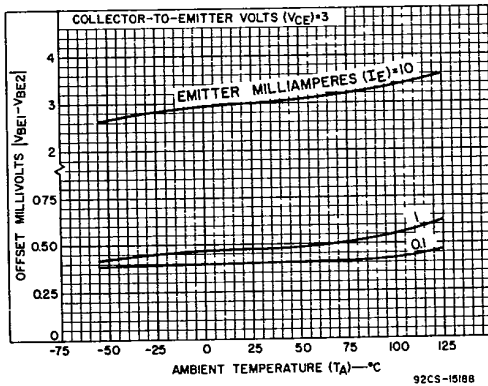

Fig. 8 - Typical Offset Voltage Characteristic vs Ambient Temperature

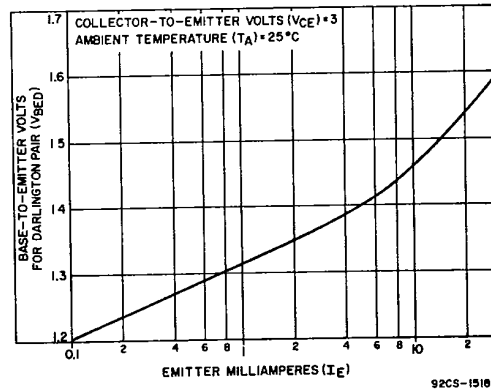

Fig. 9 - Typical Static Input Voltage Characteristic for Darlington Pair (Q_3 and Q_4) vs Emitter Current

CA3018, CA3018A

T-43-25

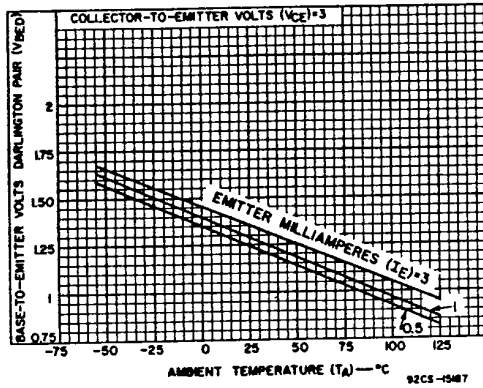

Fig. 10 - Typical Static Input Voltage Characteristic for Darlington Pair (Q_3 and Q_4) vs Ambient Temperature.

TYPICAL DYNAMIC CHARACTERISTICS FOR EACH TRANSISTOR

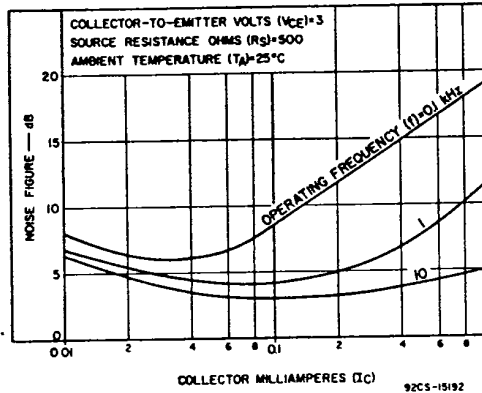

Fig. 11(a) - Noise Figure vs Collector Current, $R_S = 500 \Omega$.

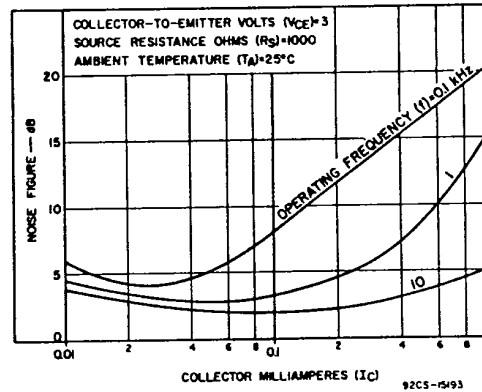

Fig. 11(b) - Noise Figure vs Collector Current, $R_S = 1 K \Omega$.

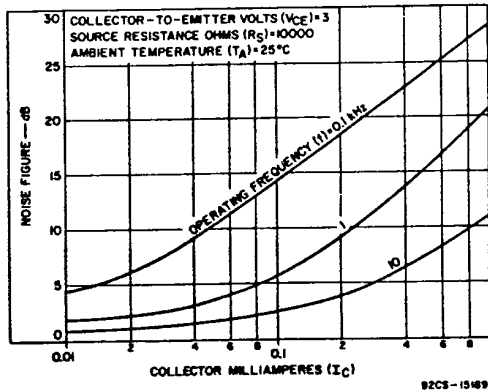

Fig. 11(c) - Noise Figure vs Collector Current, $R_S = 10 K \Omega$.

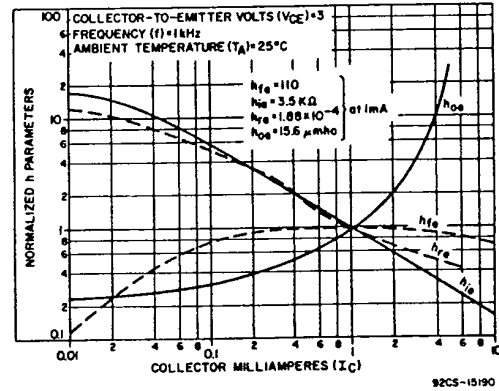

Fig. 12 - Forward Current-Transfer Ratio (h_{fe}), Short-Circuit Input Impedance (h_{ie}), Open-Circuit Output Impedance (h_{oe}), and Open-Circuit Reverse Voltage-Transfer Ratio (h_{re}) vs Collector Current

CA3018, CA3018A
 T-43-25

TYPICAL DYNAMIC CHARACTERISTICS FOR EACH TRANSISTOR

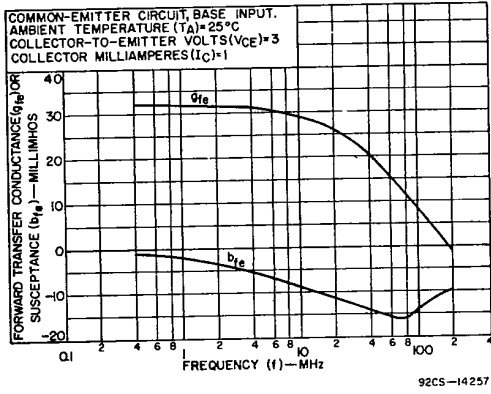

Fig. 13 - Forward Transfer Admittance (Y_{fe})

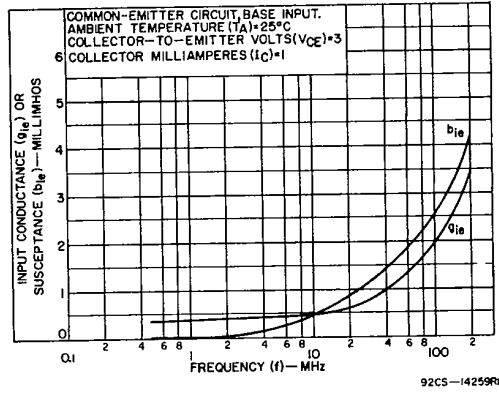

Fig. 14 - Input Admittance (Y_{ie})

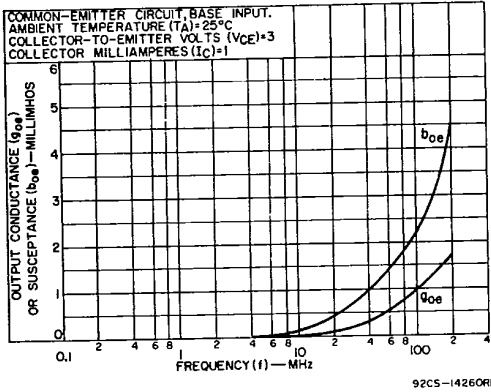

Fig. 15 - Output Admittance (Y_{oe})

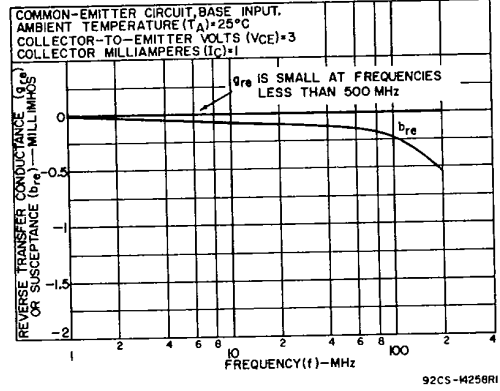

Fig. 16 - Reverse Transfer Admittance (Y_{re})

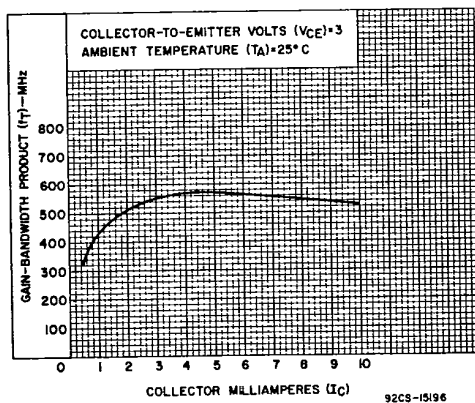

Fig. 17 - Typical Gain-Bandwidth Product (f_T) vs Collector Current