

# PRODUCT SPECIFICATION

<b>COSMO</b> ELECTRONICS CO., LTD.	PHOTO MOS RELAYS: <b>KAQY214</b>	SHEET 1 OF 7
---------------------------------------	-------------------------------------	--------------

• OUTSIDE DIMENSION :

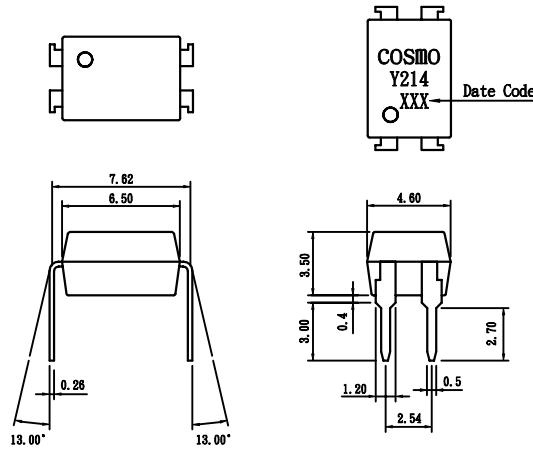

Unit:mm  
Tolerance:± 0.2 mm

• Turn on/Turn off time

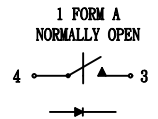
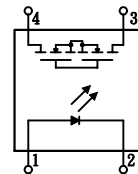
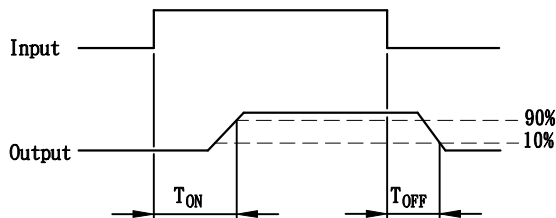

Absolute Maximum Ratings ( $T_A=25^\circ\text{C}$ )

Emitter (Input)

Reverse Voltage . . . . .	5.0V
Continuous Forward Current . . . . .	50mA
Peak Forward Current (1s) . . . . .	1A
Power Dissipation . . . . .	100mW
Derate Linearly from $25^\circ\text{C}$ . . . . .	1.3mW/ $^\circ\text{C}$

Derate Linearly from $25^\circ\text{C}$ . . . . .	2.5mW/ $^\circ\text{C}$
Storage Temperature Range . . . . .	$-40$ to $+150^\circ\text{C}$
Operating Temperature Range . . . . .	$-40$ to $+85^\circ\text{C}$
Junction Temperature . . . . .	$100^\circ\text{C}$
Soldering Temperature, 2mm from case, 10 sec. . . . .	$260^\circ\text{C}$

Detector (Output)

Output Breakdown Voltage . . . . .	± 400V
Continuous Load Current . . . . .	± 130mA
Power Dissipation . . . . .	500mW

General Characteristics

Isolation Test Voltage . . . . .	3750VAC <sub>RMS</sub>
Isolation Resistance	
$V_{10}=500\text{V}, T_A=25^\circ\text{C}$ . . . . .	$\geq 10^{10}\Omega$
Total Power Dissipation . . . . .	550mW

# PRODUCT SPECIFICATION

<b>COSMO</b> ELECTRONICS CO., LTD.	PHOTO MOS RELAYS: <b>KAQY214</b>	SHEET 2 OF 7
---------------------------------------	-------------------------------------	--------------

## Characteristics

(T<sub>A</sub> = 25° C)

Description	Symbol	Min.	Typ.	Max.	Unit	Test Condition
<b>Emitter (Input)</b>						
Forward Voltage	V <sub>F</sub>		1.8	2.0	V	I <sub>F</sub> = 10mA
Operation Input Current	I <sub>FON</sub>			5	mA	V <sub>L</sub> = ± 20V, I <sub>L</sub> = 100mA, t = 10 ms
Recovery Input Current	I <sub>FOFF</sub>	0.2			mA	V <sub>L</sub> = ± 20V, I <sub>L</sub> = <5uA
<b>Detector (Output)</b>						
Output Breakdown Voltage	V <sub>B</sub>	400			V	I <sub>B</sub> = 50uA
Output Off-State Leakage	I <sub>T(OFF)</sub>		0.2	1	uA	V <sub>T</sub> = 100V, I <sub>F</sub> = 0mA
I/O Capacitance	C <sub>ISO</sub>		6		pF	I <sub>F</sub> = 0, f = 1MHz
ON Resistance	R <sub>ON</sub>		20	30	Ω	I <sub>L</sub> = 100mA, I <sub>F</sub> = 10mA
Turn-on Time	T <sub>ON</sub>		0.3	1.0	ms	I <sub>F</sub> = 10mA, V <sub>L</sub> = ± 20V
Turn-off Time	T <sub>OFF</sub>		0.7	1.5	ms	t = 10ms, I <sub>L</sub> = ± 100mA

## Mos Relay Schematic and Wiring Diagrams

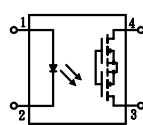
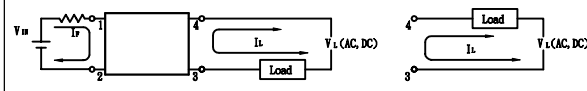
Type	Schematic	Output configuration	Load	Con-nection	Wiring diagram
KAQY214		1a	AC/DC	-	

# PRODUCT SPECIFICATION

<p><b>COSMO</b> ELECTRONICS CO., LTD.</p>	<p>PHOTO MOS RELAYS: <b>KAQY214</b></p>	<p>SHEET 3 OF 7</p>
---	---	---------------------

## DATA CURVE

Load current vs. ambient temperature  
Allowable ambient temperature:  
-40° C+85° C

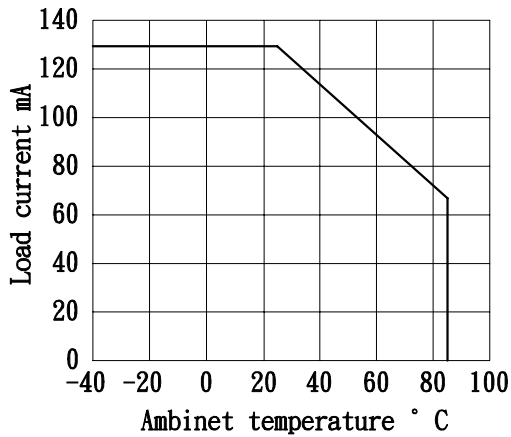

On resistance vs. ambient temperature  
Across terminals 3 and 4 pin  
LED current: 5mA  
Continuous load current: 130 mA(DC)

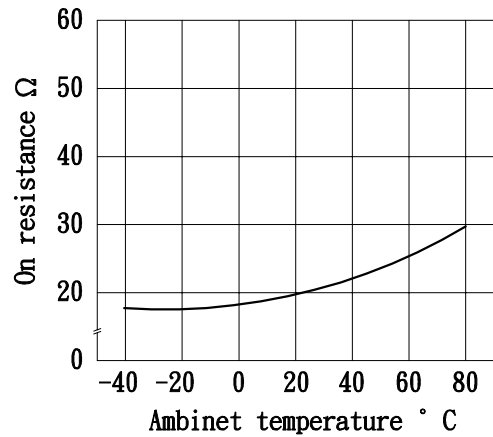

Turn on time vs. ambient temperature  
Load voltage 400 V(DC)  
LED current :5mA  
Continuous load current: 130mA(DC)

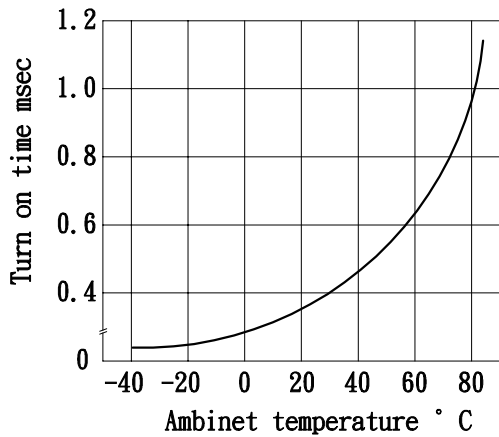

Turn off time vs. ambient temperature  
LED current: 5mA; Load voltage: 400V(DC)  
Continuous load current: 130mA(DC)

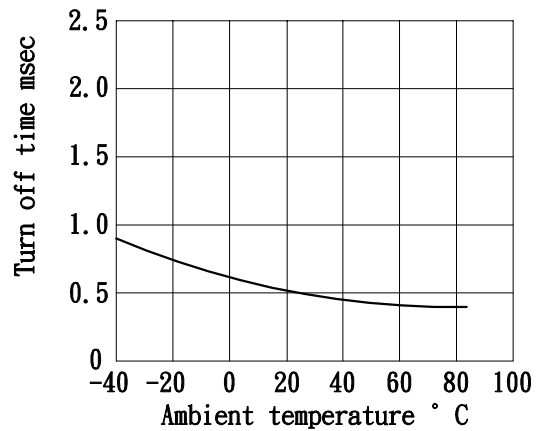

# PRODUCT SPECIFICATION

<p><b>COSMO</b> ELECTRONICS CO., LTD.</p>	<p>PHOTO MOS RELAYS: <b>KAQY214</b></p>	<p>SHEET 4 OF 7</p>
---	---	---------------------

LED operate vs. ambient temperature  
Load voltage: 400V(DC)  
Continuous load current: 130mA(DC)

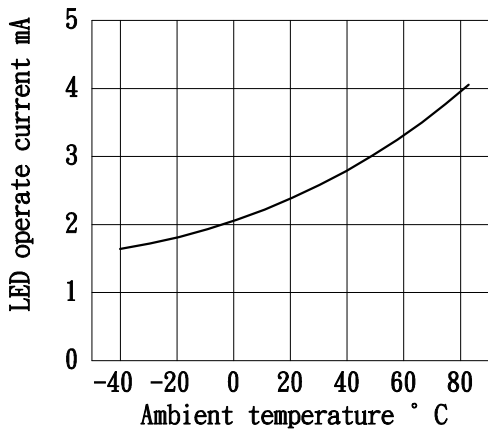

LED turn off current vs. ambient temperature  
Load voltage: 400V(DC)  
Continuons load current: 130mA(DC)

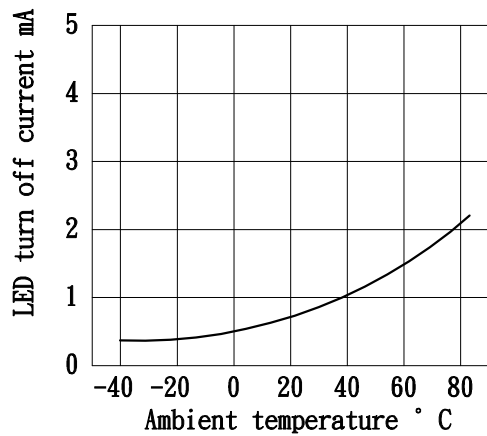

LED dropout voltage vs. ambient temperature  
LED current: 5 to 50mA

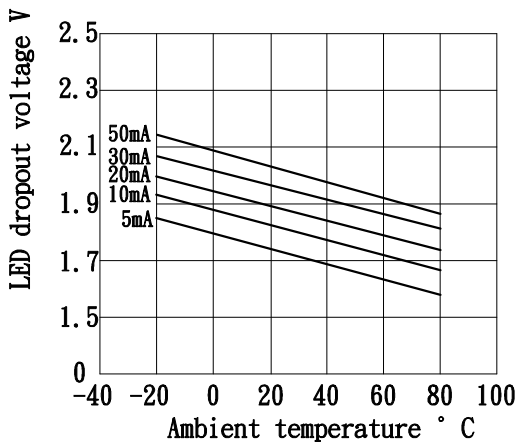

Voltage vs. current characteristics of output at MOS FET portion  
Measured portion: across terminals 3 and 4 pin  
Ambient temperature: 25° C

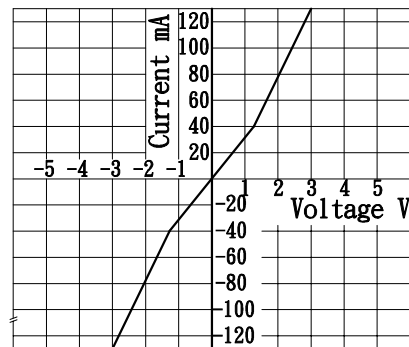

# PRODUCT SPECIFICATION

**COSMO**

ELECTRONICS CO., LTD.

PHOTO MOS RELAYS:

**KAQY214**

SHEET 5 OF 7

LED forward current vs. turn on time  
Across terminals 3 and 4pin; Load voltage: 400V(DC); Continuous load current: 130mA(DC); Ambient temperature: 25° C

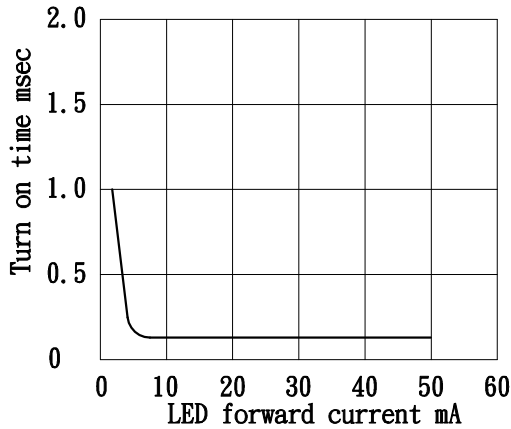

Off state leakage current  
Across terminals 3 and 4pin  
Ambient temperature: 25° C

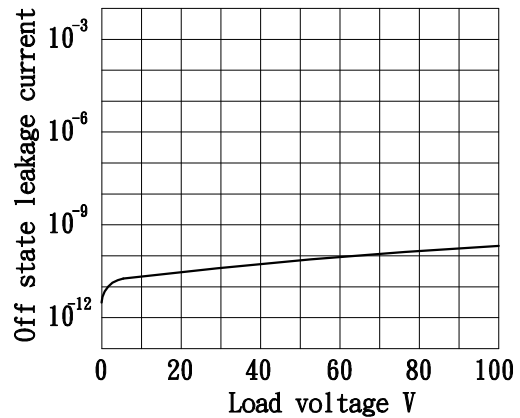

LED forward current vs. turn off time  
Across terminals 3 and 4pin; Load voltage: 400V(DC); Continuous load current: 130 mA(DC); Ambient temperature: 25° C

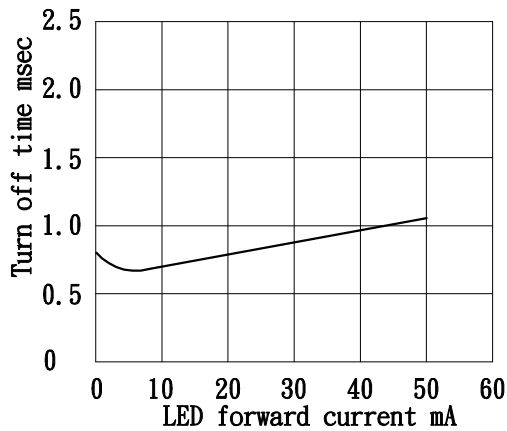

Applied voltage vs. output capacitance  
Across terminals 3 and 4pin  
Frequency: 1MHz; Ambient temperature: 25° C

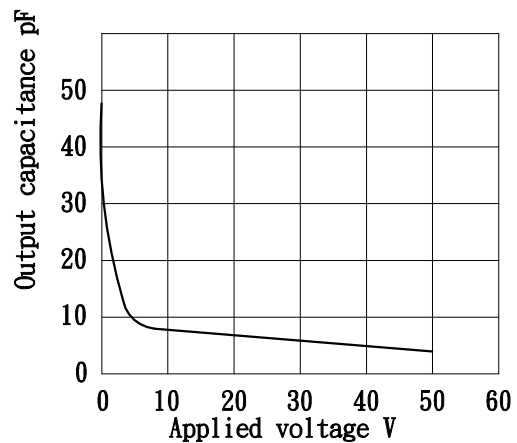

# PRODUCT SPECIFICATION

<b>COSMO</b> ELECTRONICS CO., LTD.	PHOTO MOS RELAYS: <b>KAQY214</b>	SHEET 6 OF 7
---------------------------------------	-------------------------------------	--------------

## USING METHODS

Examples of resistance value to control LED forward current  $I_F$

Photo MOSRELAY

( $I_F = 5\text{mA}$ )

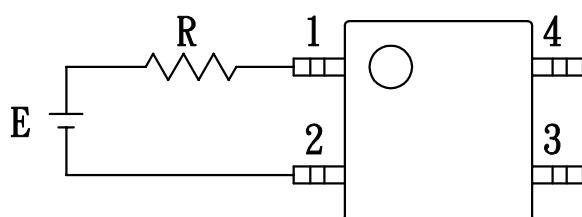

E	R
3.3V	Approx. 240 ohm
5V	Approx. 540 ohm
12V	Approx. 1.8K ohm
15V	Approx. 2.4K ohm
24V	Approx. 4K ohm

- (1) LED forward current must be more than 5mA, at E min.
- (2) LED forward current must be less than 50mA, at E max.

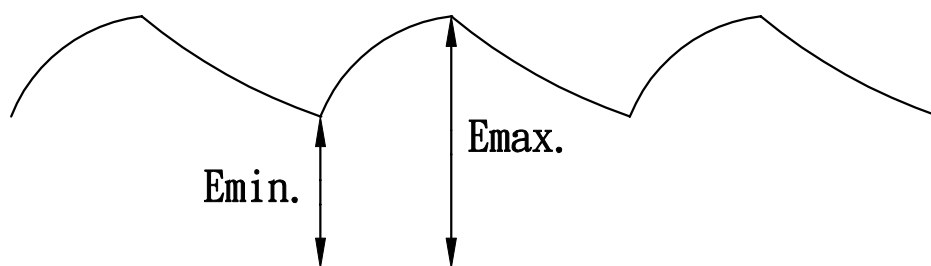

# PRODUCT SPECIFICATION

<b>COSMO</b> ELECTRONICS CO., LTD.	PHOTO MOS RELAYS: <b>KAQY214</b>	SHEET 7 OF 7
---------------------------------------	-------------------------------------	--------------

## USING METHODS

Regulate the spike voltage generated on the inductive load as follows

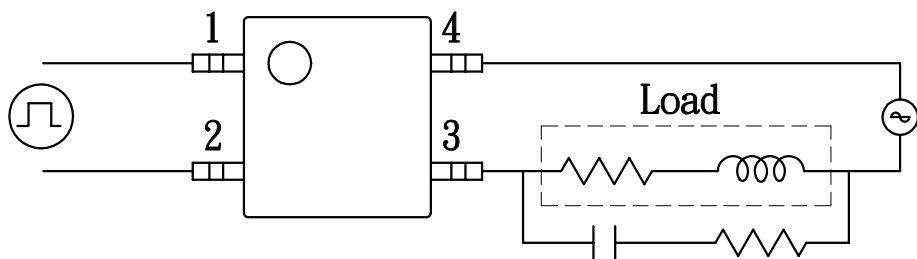
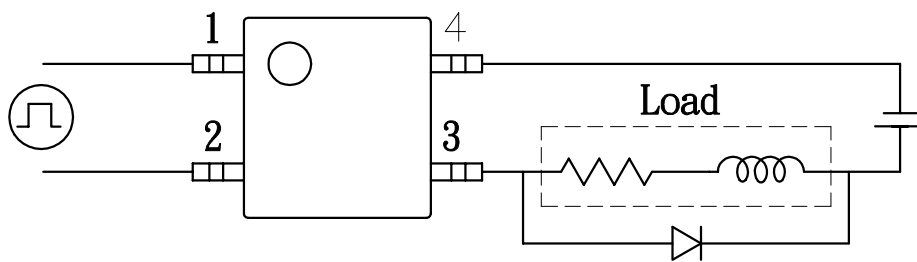

R-C Snubber