

General Description

Ideal for space critical applications, the LM4040 and LM4041 precision voltage references are available in the sub-miniature (3mm × 1.3mm) SOT-23 surface-mount package, the SO-8 surface-mount package, or the TO-92 package.

The LM4040 is available in several fixed reverse breakdown voltages: 2.500V, 4.096V, 5.000V, and 10.000V.

The LM4041 is available with a fixed 1.225V or an adjustable reverse breakdown voltage.

The LM4040 and LM4041's advanced design eliminates the need for an external stabilizing capacitor while ensuring stability with any capacitive load, making them easy to use.

The minimum operating current increases from 60μA for the LM4041-1.2 to 100μA for the LM4040-10.0. LM4040 versions have a maximum operating current of 15mA. LM4041 versions have a maximum operating current of 12mA.

The LM4040 and LM4041 utilizes zener-zap reverse breakdown voltage trim during wafer sort to ensure that the prime parts have an accuracy of better than ±0.5% (C grade) at 25°C. Bandgap reference temperature drift curvature correction and low dynamic impedance ensure stable reverse breakdown voltage accuracy over a wide range of operating temperatures and currents.

Features

- Small Package: SOT-23, TO-92, and SO-8
- No output capacitor required
- Tolerates capacitive loads
- Fixed reverse breakdown voltages of 1.225, 2.500V, 4.096V, 5.000V, and 10.000V
- Adjustable reverse breakdown version
- Contact Micrel for parts with extended temperature range.

Key Specifications

- Output voltage tolerance (C grade, 25°C) .. ±0.5% (max)
- Low output noise (10Hz to 100Hz)

LM4040	35μV _{RMS} (typ)
LM4041	20μV _{RMS} (typ)
- Wide operating current range

LM4040	60μA to 15mA
LM4041	60μA to 12mA
- Industrial temperature range
- Low temperature coefficient

Applications

- Battery-Powered Equipment
- Data Acquisition Systems
- Instrumentation
- Process Control
- Energy Management
- Product Testing
- Automotive Electronics
- Precision Audio Components

Typical Applications

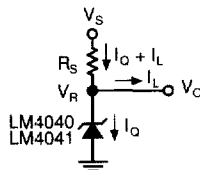

Figure 1. LM4040, LM4041 Fixed Shunt Regulator Application

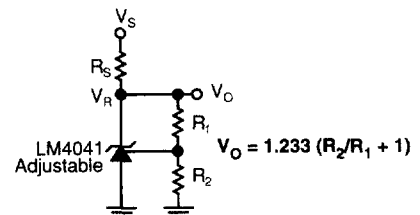
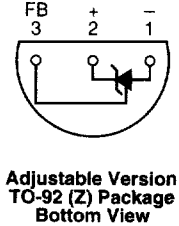
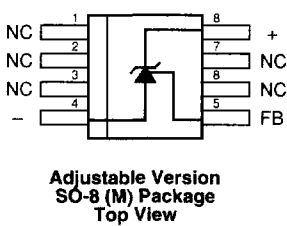
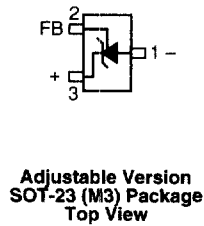
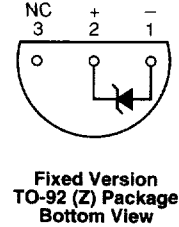
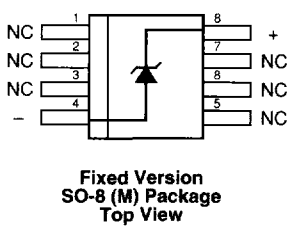
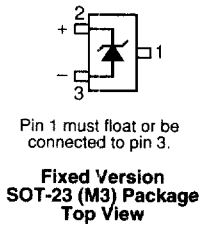

Figure 2. LM4041 Adjustable Shunt Regulator Application

Pin Configuration



Ordering Information

Part Number	Voltage	Accuracy, Temp. Coefficient
LM4040CIM3-2.5	2.500V	±0.5%, 100ppm/°C
LM4040DIM-2.5	2.500V	±1.0%, 150ppm/°C
LM4040DIM3-2.5	2.500V	±1.0%, 150ppm/°C
LM4040DIZ-2.5	2.500V	±1.0%, 150ppm/°C
LM4040EIM3-2.5	2.500V	±2.0%, 150ppm/°C
LM4040CIM3-4.1	4.096V	±0.5%, 100ppm/°C
LM4040DIM-4.1	4.096V	±1.0%, 150ppm/°C
LM4040DIM3-4.1	4.096V	±1.0%, 150ppm/°C
LM4040DIZ-4.1	4.096V	±1.0%, 150ppm/°C
LM4040CIM3-5.0	5.000V	±0.5%, 100ppm/°C
LM4040DIM-5.0	5.000V	±1.0%, 150ppm/°C
LM4040DIM3-5.0	5.000V	±1.0%, 150ppm/°C
LM4040DIZ-5.0	5.000V	±1.0%, 150ppm/°C

Part Number	Voltage	Accuracy, Temp. Coefficient
LM4040CIM3-10.0	10.00V	±0.5%, 100ppm/°C
LM4040DIM-10.0	10.00V	±1.0%, 150ppm/°C
LM4040DIM3-10.0	10.00V	±1.0%, 150ppm/°C
LM4040DIZ-10.0	10.00V	±1.0%, 150ppm/°C
LM4041CIM3-1.2	1.225V	±0.5%, 100ppm/°C
LM4041DIM-1.2	1.225V	±1.0%, 150ppm/°C
LM4041DIM3-1.2	1.225V	±1.0%, 150ppm/°C
LM4041DIZ-1.2	1.225V	±1.0%, 150ppm/°C
LM4041EIM3-1.2	1.225V	±2.0%, 150ppm/°C
LM4041CIM3-ADJ	1.24V to 10V	±0.5%, 100ppm/°C
LM4041DIM-ADJ	1.24V to 10V	±1.0%, 150ppm/°C
LM4041DIM3-ADJ	1.24V to 10V	±1.0%, 150ppm/°C
LM4041DIZ-ADJ	1.24V to 10V	±1.0%, 150ppm/°C

Contact factory for availability of 0.1% and 0.2% devices.

SOT-23 Package Markings

Example	Field	Code
R _ _	1st Character	R = Reference

Example: R4C represents *Reference, 4.096V, ±0.5%* (LM4040CIM3-4.1)

Example	Field	Code
_ 4 _	2nd Character	1 = 1.225V 2 = 2.500V 4 = 4.096V 5 = 5.000V 10 = 10.00V A = Adjustable

Example	Field	Code
_ _ A	3rd Character	C = ±0.5% D = ±1.0% E = ±2.0%

Note: If 3rd character is omitted, container will indicate tolerance.

Functional Diagram LM4040, LM4041 Fixed

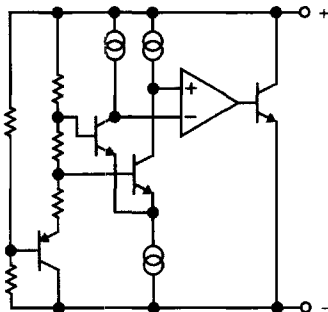

Functional Diagram LM4041 Adjustable

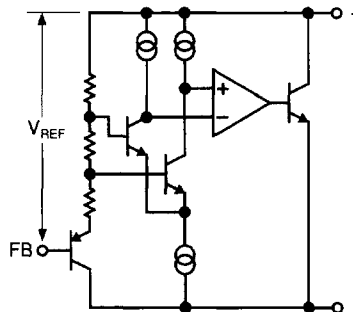

Absolute Maximum Ratings

Reverse Current	20mA
Forward Current	10mA
Maximum Output Voltage	
LM4041-Adjustable	15V
Power Dissipation ($T_A = 25^\circ\text{C}$) (Note 2)	
M Package	540mW
M3 Package	306mW
Z Package	550mW
Storage Temperature	-65°C to $+150^\circ\text{C}$
Lead Temperature	
M and M3 Packages	
Vapor phase (60 seconds)	$+215^\circ\text{C}$
Infrared (15 seconds)	$+220^\circ\text{C}$
Z Package	
Soldering (10 seconds)	$+260^\circ\text{C}$
ESD Susceptibility	
Human Body Model (Note 3)	2kV
Machine Model (Note 3)	200V

LM4040 and LM4041 Applications Information

The LM4040 and LM4041 have been designed for stable operation without the need of an external capacitor connected between the (+) and (-) pins. If a bypass capacitor is used, the references remain stable.

SOT-23 Versions

LM4040-x.x and LM4041-1.2s in the SOT-23 packages have a parasitic Schottky diode between pin 3 (-) and pin 1 (die attach interface connect). Pin 1 of the SOT-23 package must float or be connected to pin 3. LM4041-ADJs use pin 1 as the (-) output.

Operating Ratings (Notes 1 & 2)

Temperature Range	
($T_{\text{MIN}} \leq T_A \leq T_{\text{MAX}}$)	$-40^\circ\text{C} \leq T_A \leq +85^\circ\text{C}$
Reverse Current	
LM4040-2.5	60 μA to 15mA
LM4040-4.1	68 μA to 15mA
LM4040-5.0	74 μA to 15mA
LM4040-10.0	100 μA to 15mA
LM4041-1.2	60 μA to 12mA
LM4041-ADJ	60 μA to 12mA
Output Voltage Range	
LM4041-ADJ	1.24V to 10V

Conventional Shunt Regulator

In a conventional shunt regulator application (see Figure 1), an external series resistor (R_S) is connected between the supply voltage and the LM4040-x.x or LM4041-1.2 reference. R_S determines the current that flows through the load (I_L) and the reference (I_Q). Since load current and supply voltage may vary, R_S should be small enough to supply at least the minimum acceptable I_Q to the reference even when the supply voltage is at its minimum and the load current is at its

(continued following LM4041 typical characteristics)

LM4040-2.5 Electrical Characteristics

Symbol	Parameter	Conditions	Typical (Note 4)	LM4040CIM3	LM4040DIM LM4040DIM3	LM4040EIM3	Units (Limit)
				Limits (Note 5)	LM4040DIZ Limits (Note 5)	Limits (Note 5)	
V _R	Reverse Breakdown Voltage	I _R = 100μA	2.500				V
	Reverse Breakdown Voltage Tolerance	I _R = 100μA		±12 ±29	±25 ±49	±50 ±74	mV (max) mV (max)
I _{RMIN}	Minimum Operating Current		45	60	65	μA 65	μA (max) μA (max)
				65	70	70	
ΔV _R /ΔT	Average Reverse Breakdown Voltage Temperature Coefficient	I _R = 10mA	20				ppm/°C
		I _R = 1mA	15	100	150	150	ppm/°C (max)
		I _R = 100μA	15				ppm/°C (max)
ΔV _R /ΔI _R	Reverse Breakdown Voltage Change with Operating Current Change	I _{RMIN} ≤ I _R 1mA	0.3	0.8 1.0	1.0 1.2	1.0 1.2	mV mV (max) mV (max)
		1mA ≤ I _R 15mA	2.5	6.0 8.0	8.0 10.0	8.0 10.0	mV mV (max) mV (max)
Z _R	Reverse Dynamic Impedance	I _R = 1mA, f = 120Hz I _{AC} = 0.1 I _R	0.3	0.9	1.1	1.1	Ω Ω (max)
e _N	Wideband Noise	I _R = 100μA 10Hz ≤ f ≤ 10kHz	35				μV _{RMS}
ΔV _R	Reverse Breakdown Voltage Long Term Stability	t = 1000hrs T = 25°C ±0.1°C I _R = 100μA	120				ppm

LM4040-4.1 Electrical Characteristics

Symbol	Parameter	Conditions	Typical (Note 4)	LM4040CIM3	LM4040DIM LM4040DIM3	LM4040DIZ Limits (Note 5)	Units (Limits)
				Limits (Note 5)	Limits (Note 5)	Limits (Note 5)	
V _R	Reverse Breakdown Voltage	I _R = 100μA	4.096				V
	Reverse Breakdown Voltage Tolerance	I _R = 100μA		±20 ±47		±41 ±61	mV (max) mV (max)
I _{RMIN}	Minimum Operating Current		50	68		73	μA μA (max) μA (max)
				73		78	
ΔV _R /ΔT	Average Reverse Breakdown Voltage Temperature Coefficient	I _R = 10mA	30				ppm/°C
		I _R = 1mA	20	100	150		ppm/°C (max)
		I _R = 100μA	20				ppm/°C (max)
ΔV _R /ΔI _R	Reverse Breakdown Voltage Change with Operating Current Change	I _{RMIN} ≤ I _R 1mA	0.5	0.9 1.2		1.2 1.5	mV mV (max) mV (max)
		1mA ≤ I _R 15mA	3.0	7.0 10.0		9.0 13.0	mV mV (max) mV (max)
Z _R	Reverse Dynamic Impedance	I _R = 1mA, f = 120Hz I _{AC} = 0.1 I _R	0.5	1.0		1.3	Ω Ω (max)
e _N	Wideband Noise	I _R = 100μA 10Hz ≤ f ≤ 10kHz	80				μV _{RMS}
ΔV _R	Reverse Breakdown Voltage Long Term Stability	t = 1000hrs T = 25°C ±0.1°C I _R = 100μA	120				ppm

Boldface limits apply for T_A = T_J = T_{MIN} to T_{MAX}; all other limits T_A = T_J = 25°C. The grades C, D, and E designate initial Reverse Breakdown Voltage tolerance of ±0.5%, ±1.0%, and ±2.0 respectively.

LM4040-5.0 Electrical Characteristics

Symbol	Parameter	Conditions	Typical (Note 4)	LM4040CIM3 Limits (Note 5)	LM4040DIM LM4040DIM3 LM4040DIZ Limits (Note 5)	Units (Limits)
V_R	Reverse Breakdown Voltage	$I_R = 100\mu\text{A}$	5.000			V
	Reverse Breakdown Voltage Tolerance	$I_R = 100\mu\text{A}$		± 25 ± 58	± 50 ± 99	mV (max) mV (max)
I_{RMIN}	Minimum Operating Current		54	74 80	79 85	μA μA (max) μA (max)
$\Delta V_R/\Delta T$	Average Reverse Breakdown Voltage Temperature Coefficient	$I_R = 10\text{mA}$ $I_R = 1\text{mA}$ $I_R = 100\mu\text{A}$	30 20 20	100	150	ppm/ $^{\circ}\text{C}$ ppm/ $^{\circ}\text{C}$ (max) ppm/ $^{\circ}\text{C}$ (max)
$\Delta V_R/\Delta I_R$	Reverse Breakdown Voltage Change with Operating Current Change	$I_{RMIN} \leq I_R 1\text{mA}$	0.5	1.0 1.3	1.3 1.8	mV mV (max) mV (max)
		$1\text{mA} \leq I_R 15\text{mA}$	3.5	8.0 12.0	10.0 15.0	mV mV (max) mV (max)
Z_R	Reverse Dynamic Impedance	$I_R = 1\text{mA}$, $f = 120\text{Hz}$ $I_{AC} = 0.1 I_R$	0.5	1.1	1.5	Ω Ω (max)
e_N	Wideband Noise	$I_R = 100\mu\text{A}$ $10\text{Hz} \leq f \leq 10\text{kHz}$	80			μV_{RMS}
ΔV_R	Reverse Breakdown Voltage Long Term Stability	$t = 1000\text{hrs}$ $T = 25^{\circ}\text{C} \pm 0.1^{\circ}\text{C}$ $I_R = 100\mu\text{A}$	120			ppm

LM4040-10.0 Electrical Characteristics

Symbol	Parameter	Conditions	Typical (Note 4)	LM4040CIM3 Limits (Note 5)	LM4040DIM LM4040DIM3 LM4040DIZ Limits (Note 5)	Units (Limits)
V_R	Reverse Breakdown Voltage	$I_R = 150\mu\text{A}$	10.00			V
	Reverse Breakdown Voltage Tolerance	$I_R = 150\mu\text{A}$		± 50 ± 115	± 100 ± 198	mV (max) mV (max)
I_{RMIN}	Minimum Operating Current		75	100 103	110 113	μA μA (max) μA (max)
$\Delta V_R/\Delta T$	Average Reverse Breakdown Voltage Temperature Coefficient	$I_R = 10\text{mA}$ $I_R = 1\text{mA}$ $I_R = 150\mu\text{A}$	40 20 20	100	150	ppm/ $^{\circ}\text{C}$ ppm/ $^{\circ}\text{C}$ (max) ppm/ $^{\circ}\text{C}$ (max)
$\Delta V_R/\Delta I_R$	Reverse Breakdown Voltage Change with Operating Current Change	$I_{RMIN} \leq I_R 1\text{mA}$	0.8	1.5 3.5	2.0 4.0	mV mV (max) mV (max)
		$1\text{mA} \leq I_R 15\text{mA}$	8.0	12.0 23.0	18.0 29.0	mV mV (max) mV (max)
Z_R	Reverse Dynamic Impedance	$I_R = 1\text{mA}$, $f = 120\text{Hz}$ $I_{AC} = 0.1 I_R$	0.7	1.7	2.3	Ω Ω (max)
e_N	Wideband Noise	$I_R = 150\mu\text{A}$ $10\text{Hz} \leq f \leq 10\text{kHz}$	180			μV_{RMS}
ΔV_R	Reverse Breakdown Voltage Long Term Stability	$t = 1000\text{hrs}$ $T = 25^{\circ}\text{C} \pm 0.1^{\circ}\text{C}$ $I_R = 150\mu\text{A}$	120			ppm

Boldface limits apply for $T_A = T_J = T_{MIN}$ to T_{MAX} ; all other limits $T_A = T_J = 25^{\circ}\text{C}$. The grades C and D designate initial Reverse Breakdown Voltage tolerance of $\pm 0.5\%$ and $\pm 1.0\%$ respectively.

LM4040 Typical Characteristics

Temperature Drift for Different Average Temperature Coefficient

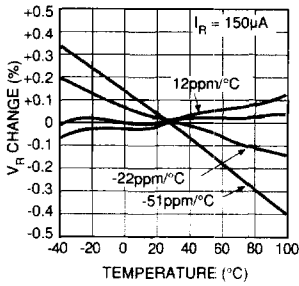

Output Impedance vs. Frequency

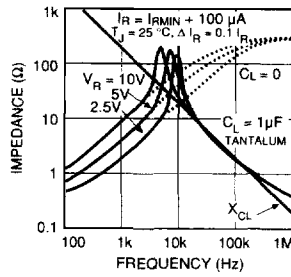

Output Impedance vs. Frequency

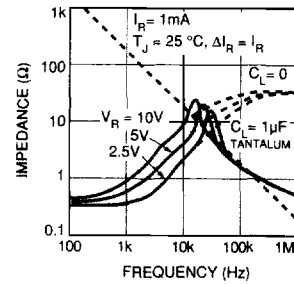

Reverse Characteristics and Minimum Operating Current

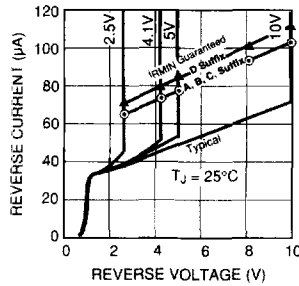

Noise Voltage vs. Frequency

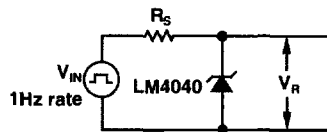
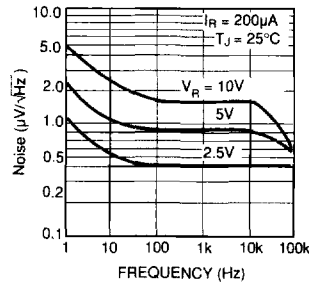

Test Circuit

LM4040-2.5 $R_S = 30\text{k}$

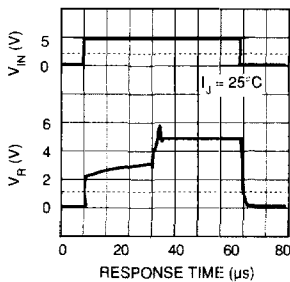

LM4040-5.0 $R_S = 30\text{k}$

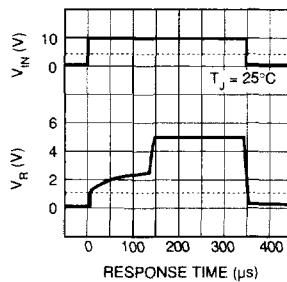

LM4040-10.0 $R_S = 30\text{k}$

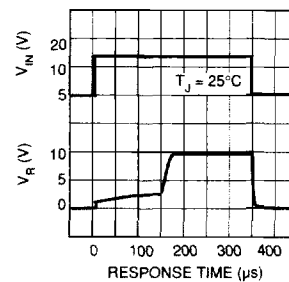

LM4041-1.2 Electrical Characteristics

Symbol	Parameter	Conditions	Typical (Note 4)	LM4041CIM3		Units (Limit)
				Limits (Note 5)		
V_R	Reverse Breakdown Voltage	$I_R = 100\mu A$	1.225			V
	Reverse Breakdown Voltage Tolerance	$I_R = 100\mu A$		± 6 ± 14		mV (max) mV (max)
I_{RMIN}	Minimum Operating Current		45	60		μA μA (max)
				65		μA (max)
$\Delta V_R/\Delta T$	Average Reverse Breakdown Voltage Temperature Coefficient	$I_R = 10mA$	20	± 100		ppm/ $^{\circ}C$
		$I_R = 1mA$	15			ppm/ $^{\circ}C$ (max)
		$I_R = 100\mu A$	15			ppm/ $^{\circ}C$ (max)
$\Delta V_R/\Delta I_R$	Reverse Breakdown Voltage Change with Operating Current Change	$I_{RMIN} \leq I_R 1mA$	0.7	1.5 2.0		mV mV (max) mV (max)
		$1mA \leq I_R 12mA$	4.0	6.0 8.0		mV mV (max) mV (max)
Z_R	Reverse Dynamic Impedance	$I_R = 1mA, f = 120Hz$ $I_{AC} = 0.1 I_R$	0.5	1.5		Ω Ω (max)
e_N	Wideband Noise	$I_R = 100\mu A$ $10Hz \leq f \leq 10kHz$	20			μV_{RMS}
ΔV_R	Reverse Breakdown Voltage Long Term Stability	$t = 1000hrs$ $T = 25^{\circ}C \pm 0.1^{\circ}C$ $I_R = 100\mu A$	120			ppm

Symbol	Parameter	Conditions	Typical (Note 4)	LM4041DIM LM4041DIM3 LM4041DIZ Limits (Note 5)	LM4041EIM3 Limits (Note 5)	Units (Limit)
V_R	Reverse Breakdown Voltage	$I_R = 100\mu A$	1.225			V
	Reverse Breakdown Voltage Tolerance	$I_R = 100\mu A$		± 12 ± 24	± 25 ± 36	mV (max) mV (max)
I_{RMIN}	Minimum Operating Current		45	65	65	μA μA (max)
				70	70	μA (max)
$\Delta V_R/\Delta T$	Average Reverse Breakdown Voltage Temperature Coefficient	$I_R = 10mA$	20	± 150	± 150	ppm/ $^{\circ}C$
		$I_R = 1mA$	15			ppm/ $^{\circ}C$ (max)
		$I_R = 100\mu A$	15			ppm/ $^{\circ}C$ (max)
$\Delta V_R/\Delta I_R$	Reverse Breakdown Voltage Change with Operating Current Change	$I_{RMIN} \leq I_R 1mA$	0.3	2.0 2.5	2.0 2.5	mV mV (max) mV (max)
		$1mA \leq I_R 15mA$	2.5	8.0 10.0	8.0 10.0	mV mV (max) mV (max)
Z_R	Reverse Dynamic Impedance	$I_R = 1mA, f = 120Hz$ $I_{AC} = 0.1 I_R$	0.3	2.0	2.0	Ω Ω (max)
e_N	Wideband Noise	$I_R = 100\mu A$ $10Hz \leq f \leq 10kHz$	35			μV_{RMS}
ΔV_R	Reverse Breakdown Voltage Long Term Stability	$t = 1000hrs$ $T = 25^{\circ}C \pm 0.1^{\circ}C$ $I_R = 100\mu A$	120			ppm

Boldface limits apply for $T_A = T_J = T_{MIN}$ to T_{MAX} ; all other limits $T_A = T_J = 25^{\circ}C$. The grades C, D, and E designate initial Reverse Breakdown Voltage tolerance of $\pm 0.5\%$, $\pm 1.0\%$, and $\pm 2.0\%$ respectively.

LM4041-Adjustable Electrical Characteristics

Symbol	Parameter	Conditions	Typical (Note 4)	LM4041CIM3 Limits (Note 5)	LM4041DIM LM4041DIM3 LM4041DIZ Limits (Note 5)	Units (Limit)
V_{REF}	Reference Breakdown Voltage	$I_R = 100\mu A$ $V_{OUT} = 5V$	1.233			V
	Reference Breakdown Voltage Tolerance (Note 8)	$I_R = 100\mu A$		± 6.2 ± 14	± 12 ± 24	mV (max) mV (max)
I_{RMIN}	Minimum Operating Current		45	60 65	65 70	μA μA (max) μA (max)
$\frac{\Delta V_{REF}}{\Delta I_R}$	Reference Voltage Change with Operating Current Change	$I_{RMIN} \leq I_R 1mA$ SOT-23: $V_{OUT} \geq 1.6V$ (Note 7)	0.7	1.5 2.0	2.0 2.5	mV mV (max) mV (max)
		$1mA \leq I_R 12mA$ SOT-23: $V_{OUT} \geq 1.6V$ (Note 7)	2	4 6	6 8	mV mV (max) mV (max)
$\frac{\Delta V_{REF}}{\Delta V_O}$	Reference Voltage Change with Output Voltage Change	$I_R = 1mA$	-1.3	-2.0 -2.5	-2.5 -3.0	mV/V mV/V (max) mV/V (max)
I_{FB}	Feedback Current		60	100 120	150 200	nA nA (max) nA (max)
$\frac{\Delta V_{REF}}{\Delta T}$	Average Reference Voltage Temperature Coefficient (Note 8)	$V_{OUT} = 5V$ $I_R = 10mA$ $I_R = 1mA$ $I_R = 100\mu A$	20 15 15	± 100	± 150	ppm/ $^{\circ}C$ ppm/ $^{\circ}C$ (max) ppm/ $^{\circ}C$ (max)
Z_{OUT}	Dynamic Output Impedance	$I_R = 1mA, f = 120Hz$ $I_{AC} = 0.1 I_R$ $V_{OUT} = V_{REF}$ $V_{OUT} = 10V$	0.3 2			Ω Ω (max)
e_N	Wideband Noise	$I_R = 100\mu A$ $10Hz \leq f \leq 10kHz$	20			μV_{RMS}
ΔV_{REF}	Reference Voltage Long Term Stability	$t = 1000hrs$ $T = 25^{\circ}C \pm 0.1^{\circ}C$ $I_R = 100\mu A$	120			ppm

Boldface limits apply for $T_A = T_J = T_{MIN}$ to T_{MAX} ; all other limits $T_J = 25^{\circ}C$ unless otherwise specified (SOT-23, see Note 7), $I_{RMIN} \leq I_R < 12mA$, $V_{REF} \leq V_{OUT} \leq 10V$. The grades C and D designate initial Reverse Breakdown Voltage tolerance of $\pm 0.5\%$ and $\pm 1\%$, respectively for $V_{OUT} = 5V$.

LM4040 and LM4041 Electrical Characteristic Notes

- Note 1** Absolute Maximum Ratings indicate limits beyond which damage to the device may occur. Operating Ratings indicate conditions for which the device is functional, but do not guarantee specific performance limits. For guaranteed specification and test conditions, see the Electrical Characteristics. The guaranteed specifications apply only for the test conditions listed. Some performance characteristics may degrade when the device is not operated under the listed test conditions.
- Note 2** The maximum power dissipation must be derated at elevated temperatures and is dictated by T_{JMAX} (maximum junction temperature), θ_{JA} (junction to ambient thermal resistance), and T_A (ambient temperature). The maximum allowable power dissipation at any temperature is $PD_{MAX} = (T_{JMAX} - T_A)/\theta_{JA}$ or the number given in the Absolute Maximum Ratings, whichever is lower. For the LM4040 and LM4041, $T_{JMAX} = 125^\circ\text{C}$, and the typical thermal resistance (θ_{JA}), when board mounted, is 185°C/W for the M package, 326°C/W for the SOT-23 package, and 180°C/W with $0.4''$ lead length and 170°C/W with $0.125''$ lead length for the TO-92 package.
- Note 3** The human body model is a 100pF capacitor discharged through a 1.5k Ω resistor into each pin. The machine model is a 200pF capacitor discharged directly into each pin.
- Note 4** Typical values are at $T_J = 25^\circ\text{C}$ and represent most likely parametric norm.
- Note 5** Limits are 100% production tested at 25°C . Limits over temperature are guaranteed through correlation using Statistical Quality Control (SQL) methods.
- Note 6** The boldface (over temperature limit for Reverse Breakdown Voltage Tolerance is defined as the room temperature Reverse Breakdown Voltage Tolerance $\pm[(\Delta V_R/\Delta T)(65^\circ\text{C})(V_R)]$. $\Delta V_R/\Delta T$ is the V_R temperature coefficient, 65°C is the temperature range from -40°C to the reference point of 25°C , and V_R is the reverse breakdown voltage. The total over temperature tolerance for the different grades follows:
 C-grade: $\pm 1.15\% = \pm 0.5\% \pm 100\text{ppm}/^\circ\text{C} \times 65^\circ\text{C}$
 D-grade: $\pm 1.98\% = \pm 1.0\% \pm 150\text{ppm}/^\circ\text{C} \times 65^\circ\text{C}$
 E-grade: $\pm 2.98\% = \pm 1.0\% \pm 150\text{ppm}/^\circ\text{C} \times 65^\circ\text{C}$
 Example: The C-grade LM4040-2.5 has an over temperature Reverse Breakdown Voltage tolerance of $\pm 2.5 \times 1.15\% = \pm 28.75\text{mV}$.
- Note 7** When $V_{OUT} \leq 1.6\text{V}$, the LM4041-ADJ in the SOT-23 package must operate at reduced I_R . This is caused by the series resistance of the die attach between the die (-) output and the package (-) output pin. See the Output Saturation (SOT-23 only) curve in the Typical Performance Characteristics section.
- Note 8** Reference voltage and temperature coefficient will change with output voltage. See Typical Performance Characteristics curves.

LM4041 Typical Characteristics

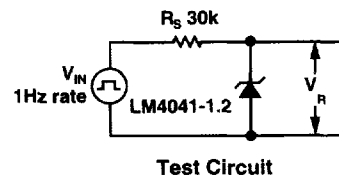
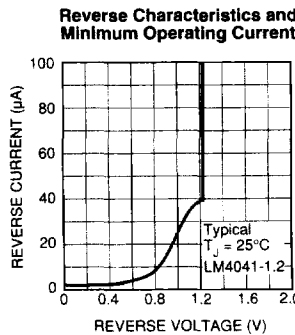
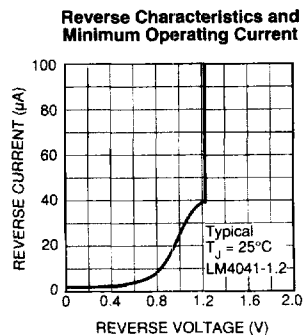
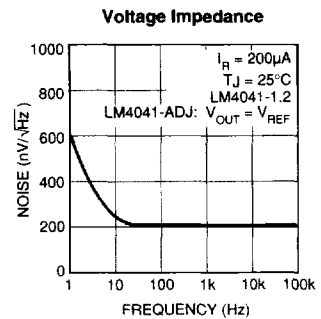
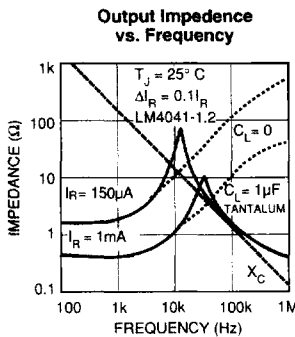
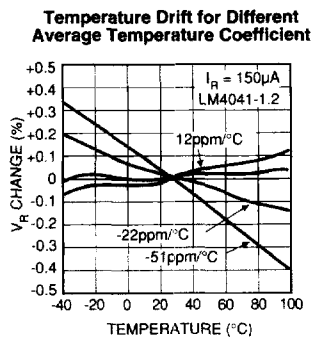

LM4041 Typical Characteristics

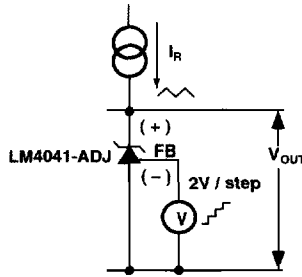
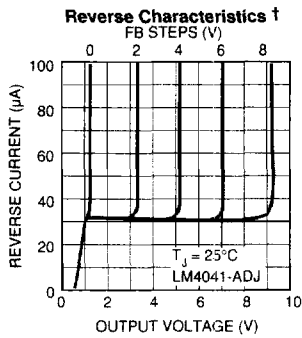
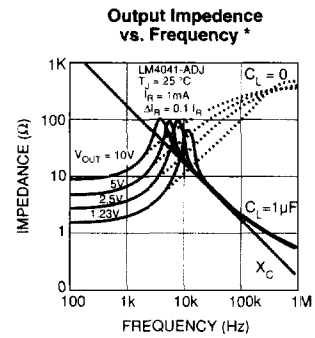
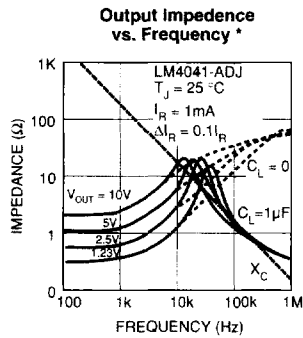
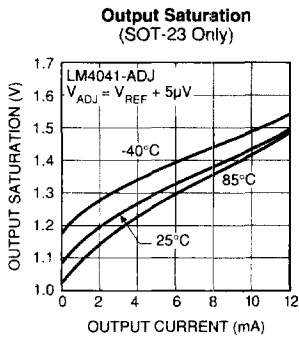
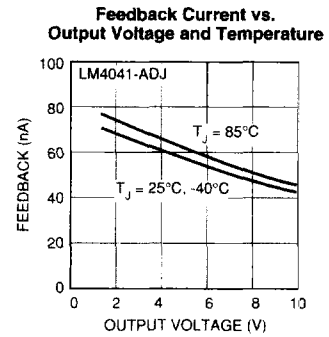
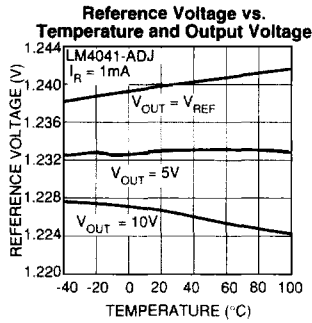
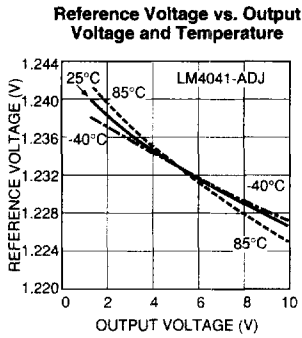

† Reverse Characteristics Test Circuit

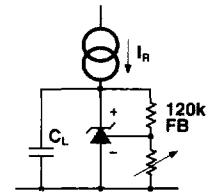

* Output Impedance vs. Freq. Test Circuit

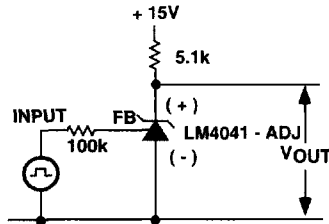
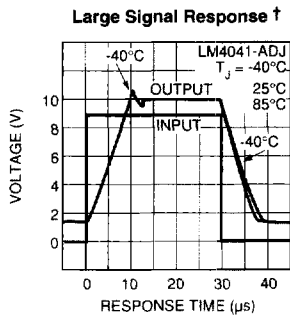

‡ Large Signal Response Test Circuit

maximum value. When the supply voltage is at its maximum and I_L is at its minimum, R_S should be large enough so that the current flowing through the LM4040-x.x is less than 15mA, and the current flowing through the LM4041-1.2 or LM4041-ADJ is less than 12mA.

R_S is determined by the supply voltage (V_S), the load and operating current, (I_L and I_Q), and the reference's reverse breakdown voltage (V_R).

$$R_s = (V_s - V_R) / (I_L + I_Q)$$

Adjustable Regulator

The LM4041-ADJ's output voltage can be adjusted to any value in the range of 1.24V through 10V. It is a function of the internal reference voltage (V_{REF}) and the ratio of the external feedback resistors as shown in Figure 2. The output is found using the equation

$$(1) \quad V_O = V_{REF} [(R_2/R_1) + 1]$$

where V_O is the desired output voltage. The actual value of the internal V_{REF} is a function of V_O . The "corrected" V_{REF} is determined by

$$(2) \quad V_{REF}' = V_O (\Delta V_{REF} / \Delta V_O) + V_Y$$

where V_O is the desired output voltage. $\Delta V_{REF} / \Delta V_O$ is found in the Electrical Characteristics and is typically $-1.3mV/V$ and V_Y is equal to 1.233V. Replace the value of V_{REF}' in equation (1) with the value found using equation (2).

Note that actual output voltage can deviate from that predicted using the typical $\Delta V_{REF} / \Delta V_O$ in equation (2); for C-grade parts, the worst-case $\Delta V_{REF} / \Delta V_O$ is $-2.5mV/V$ and $V_Y = 1.248V$.

The following example shows the difference in output voltage resulting from the typical and worst case values of $\Delta V_{REF} / \Delta V_O$:

Let $V_O = +9V$. Using the typical values of $\Delta V_{REF} / \Delta V_O$, V_{REF} is 1.228V. Choosing a value of $R_1 = 10k\Omega$, $R_2 = 63.272k\Omega$. Using the worst case $\Delta V_{REF} / \Delta V_O$ for the C-grade and D-grade parts, the output voltage is actually 8.965V and 8.946V respectively. This results in possible errors as large as 0.39% for the C-grade parts and 0.59% for the D-grade parts. Once again, resistor values found using the typical value of $\Delta V_{REF} / \Delta V_O$ will work in most cases, requiring no further adjustment.

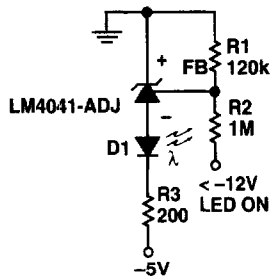

Figure 3. Voltage Level Detector

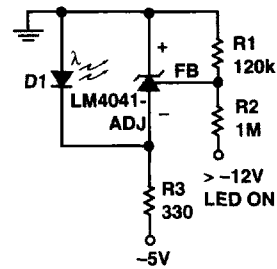

Figure 4. Voltage Level Detector

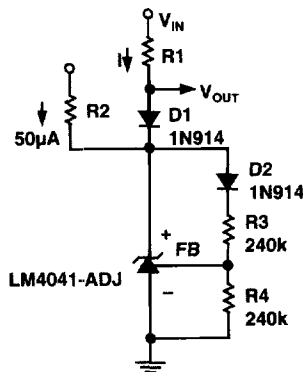

Figure 5. Fast Positive Clamp
2.4V + ΔV_{D1}

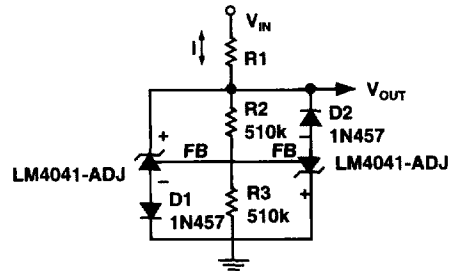

Figure 6. Bidirectional Clamp
 $\pm 2.4V$

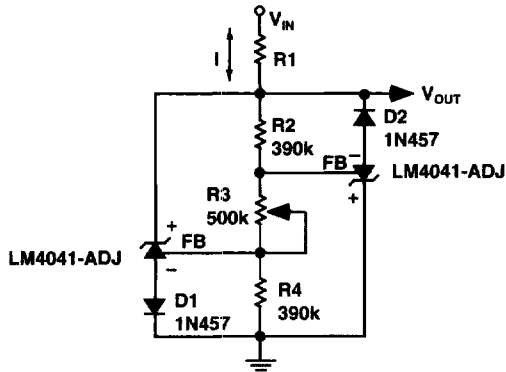

Figure 7. Bidirectional Adjustable Clamp
±18V to ±2.4V

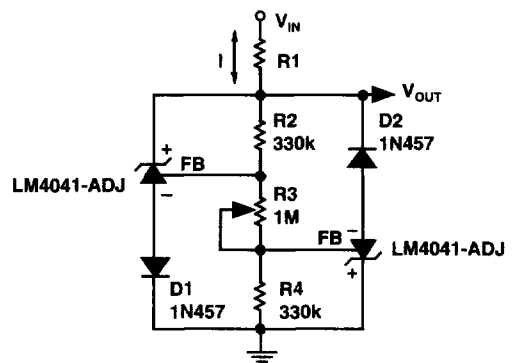

Figure 8. Bidirectional Adjustable Clamp
±2.4 to ±6V

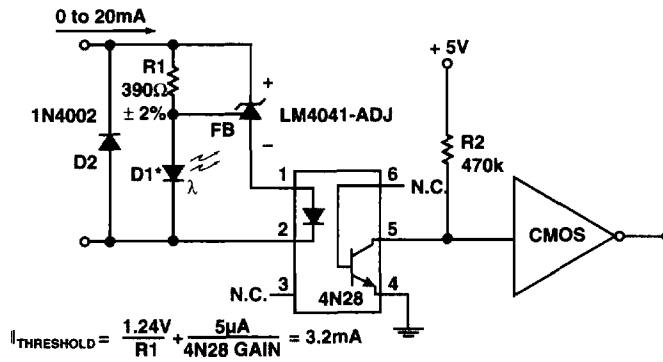

Figure 9. Floating Current Detector

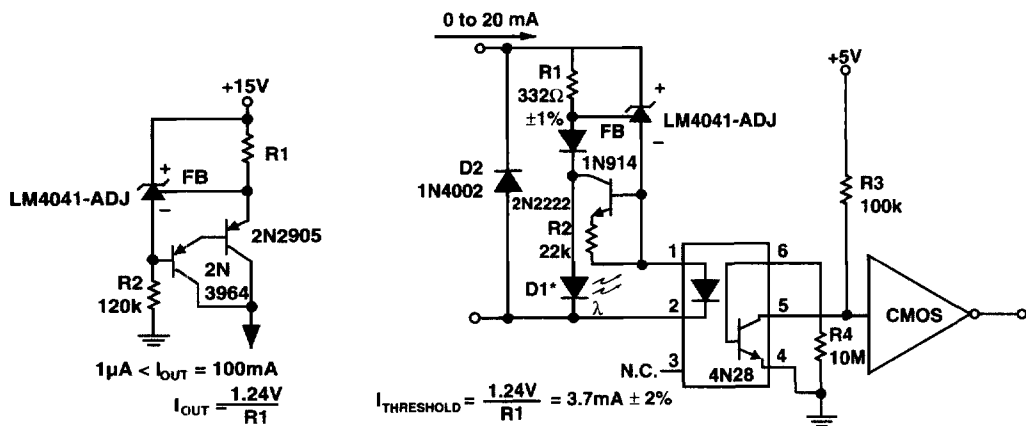

Figure 10. Current Source

Figure 11. Precision Floating Current Detector

* D1 can be any LED, $V_F = 1.5\text{V to }2.2\text{V}$ at 3mA . D1 may act as an indicator. D1 will be on if $I_{\text{THRESHOLD}}$ falls below the threshold current, except with $I = 0$.