

# 28–32 GHz Surface Mount Driver Amplifier



**AA031P1-A2**

Patent Pending

## Features

- Surface Mount Package
- 17 dB Typical Gain
- 16 dBm Typical  $P_{1\text{ dB}}$  Output Power
- Single Voltage Operation
- 100% RF and DC Testing

## Description

The AA031P1-A2 is a broadband millimeterwave driver amplifier in a rugged surface mount package which is compatible with high volume solder installation. The amplifier is designed for use in millimeterwave communication and sensor systems as a gain stage in the receiver, transmitter, or LO chain when high gain and linearity are required. The robust ceramic surface mount package provides excellent electrical performance and a high degree of environmental protection for long-term reliability. A single supply voltage simplifies bias requirements. All amplifiers are screened at the operating frequencies prior to shipment for guaranteed performance. Amplifier is targeted for high volume millimeterwave applications such as satellite and wireless point-to-point and point-to-multipoint systems.

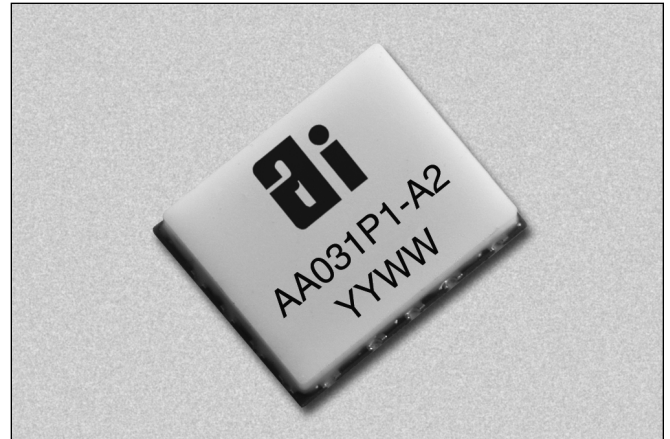

## Pin Out

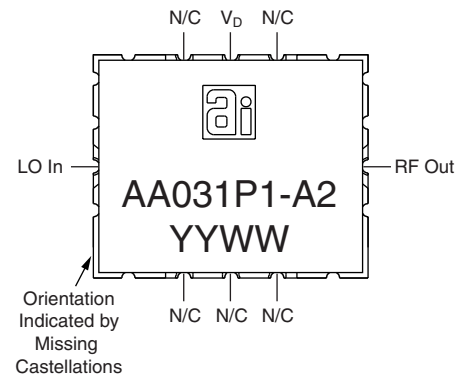

## Electrical Specifications at 25°C ( $V_D = 5.5\text{ V}$ )

Parameter	Symbol	Min.	Typ.	Max.	Unit
Bandwidth	BW	28		32	GHz
Small Signal Gain	G	14	17		dB
Output Power at 1 dB Gain Compression	$P_{1\text{ dB}}$	13	16		dBm
Input Return Loss	$RL_I$		9		dB
Output Return Loss	$RL_O$		12		dB
Temperature Coefficient of Gain	dG/dT		-0.03		dB/C
Drain Current	$I_D$		145	200	mA

**Typical Performance Data ( $V_D = 5.5\text{ V}$ )**

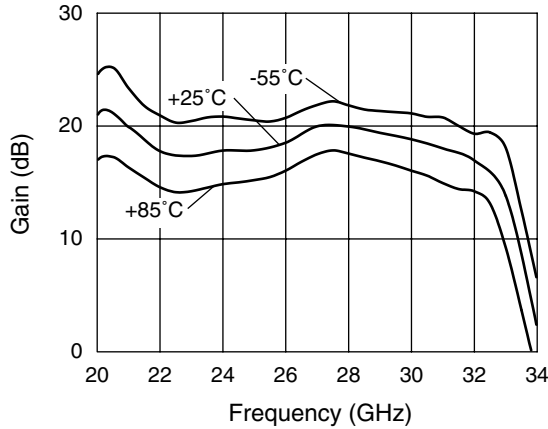

**Gain vs. Frequency**

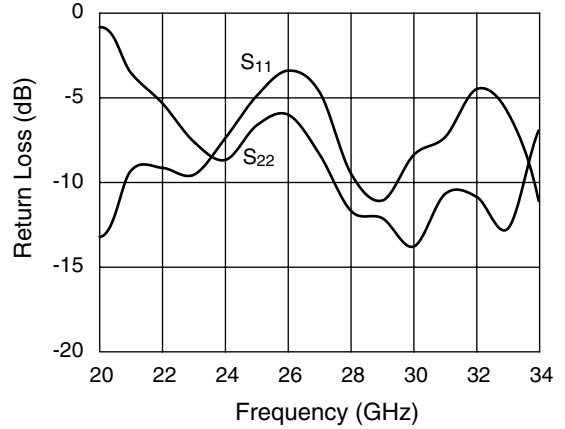

**Return Loss vs. Frequency**

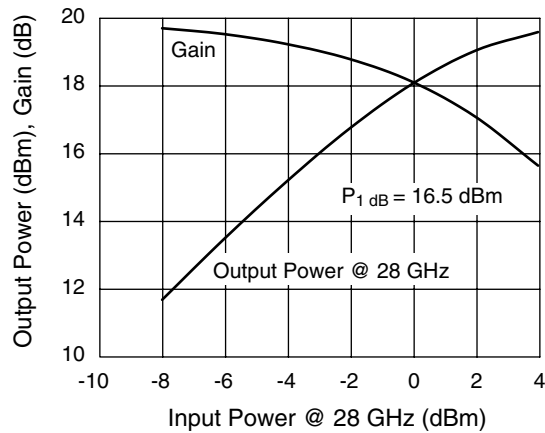

**Power Sweep**

**Absolute Maximum Ratings**

Characteristic	Value
Operating Temperature ( $T_C$ )	-55°C to +90°C
Storage Temperature ( $T_{ST}$ )	-65°C to +150°C
Bias Voltage ( $V_D$ )	7 V <sub>DC</sub>
Power In ( $P_{IN}$ )	13 dBm

**Outline**

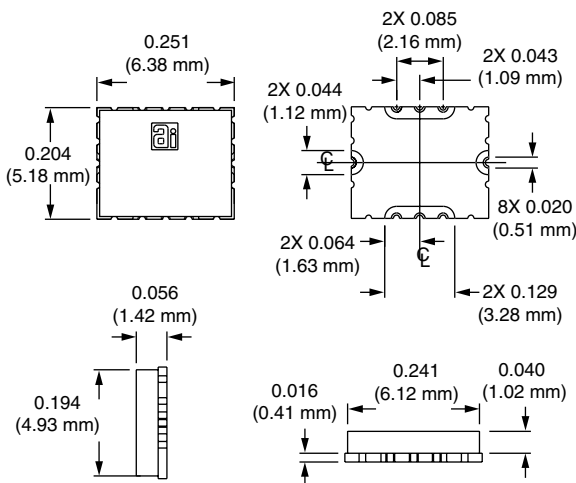

**Typical S-Parameters at 25°C ( $V_D = 5.5$  V)**

Frequency (GHz)	S <sub>11</sub>		S <sub>21</sub>		S <sub>12</sub>		S <sub>22</sub>	
	Mag. (dB)	Ang. (Deg.)	Mag. (dB)	Ang. (Deg.)	Mag. (dB)	Ang. (Deg.)	Mag. (dB)	Ang. (Deg.)
10	-3.32	-165.1	-65.68	-16.4	-70.52	-40.5	-0.82	174.0
12	-3.84	113.0	-59.03	170.4	-53.25	-168.5	-1.13	75.8
14	-2.84	78.4	-38.70	-91.9	-50.91	-22.7	-1.49	-29.6
16	-3.41	-40.4	-21.40	119.0	-52.54	-122.8	-1.73	-123.0
18	-10.02	-139.9	1.34	-20.6	-38.22	155.4	-4.21	107.0
20	-13.22	87.2	20.89	102.6	-39.34	-22.8	-0.83	-93.7
21	-9.29	4.1	19.91	-35.4	-49.36	-107.1	-3.54	-134.2
22	-9.14	-40.1	17.77	-131.6	-53.05	91.8	-5.33	-145.4
23	-9.54	-75.9	17.35	147.8	-48.28	5.4	-7.60	-173.7
24	-7.37	-129.9	17.83	62.5	-46.34	-47.3	-8.66	116.4
25	-4.88	178.7	17.85	-20.5	-47.02	-104.6	-6.62	46.2
26	-3.39	137.0	18.52	-100.1	-49.02	-141.6	-6.00	0
27	-4.67	89.2	19.97	171.9	-48.24	128.9	-8.35	-51.4
28	-9.49	34.0	19.96	77.0	-49.94	-19.1	-11.68	-101.6
29	-11.06	-24.5	19.40	-13.4	-49.90	-94.5	-12.12	-132.1
30	-8.36	-68.0	18.83	-105.9	-48.98	-153.7	-13.78	-141.5
31	-7.30	-99.3	18.02	157.3	-48.38	-175.2	-10.66	-153.7
32	-4.48	-123.0	16.95	55.6	-49.77	162.8	-10.85	160.3
33	-5.91	-175.8	13.82	-80.0	-39.10	124.8	-12.70	-157.8
34	-11.35	160.7	2.17	169.9	-41.13	43.7	-6.80	156.5
35	-24.14	148.8	-11.51	100.5	-42.26	10.9	-5.14	95.8
36	-18.29	-103.1	-16.73	84.1	-41.48	-30.5	-3.96	34.5
37	-8.44	-110.7	-19.28	20.0	-38.59	-97.0	-3.06	-14.5
38	-6.32	-146.3	-22.45	-38.8	-39.95	162.5	-2.79	-52.4
40	-4.39	157.0	-18.33	121.4	-42.95	64.1	-2.39	-129.2

## “Alpha Two” Surface Mount Package Handling and Mounting

Millimeterwave components require careful mounting design to maintain optimal performance. The Alpha Two surface mount package (patent pending) provides a rugged and repeatable electrical connection using standard solder techniques.

### Handling

The Alpha Two surface mount package is very rugged. However, due to ceramic’s brittle nature, one should exercise care when handling with metal tools. Do not apply heavy pressure to the lid. Vacuum tools may be used to pick and place this part.

Only personnel trained in both ESD precautions and handling precautions should be allowed to handle these packages.

### Package Construction

The Alpha Two surface mount package consists of a base and a lid. The package base is ceramic with filled vias and plated castellations. The package lid is unplated alumina. The lid seal is epoxy.

### Mounting Design

The Alpha Two surface mount package is installed on top of a printed circuit board on a specially designed footprint. Mounting footprint geometry will be supplied by Alpha Industries in electronic formats or paper drawing.

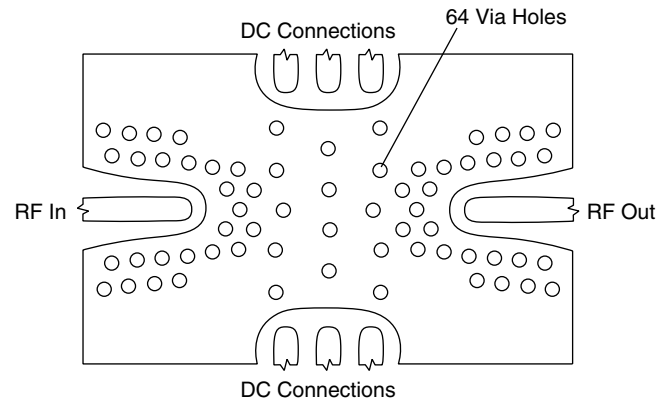

**Footprint Geometry for Alpha Two Surface Mount Package**

### Mounting the Package

The Alpha Two surface mount package is compatible with high-volume surface mount installation using solder. RF and DC connections are accomplished with metallized edge castellations that hold solder fillets. Ground connections are accomplished by both metallized edge castellations and filled vias to the bottom of the package. Care should be taken to ensure that there are no voids or gaps in the solder so that a good RF, DC, and ground contact is maintained.

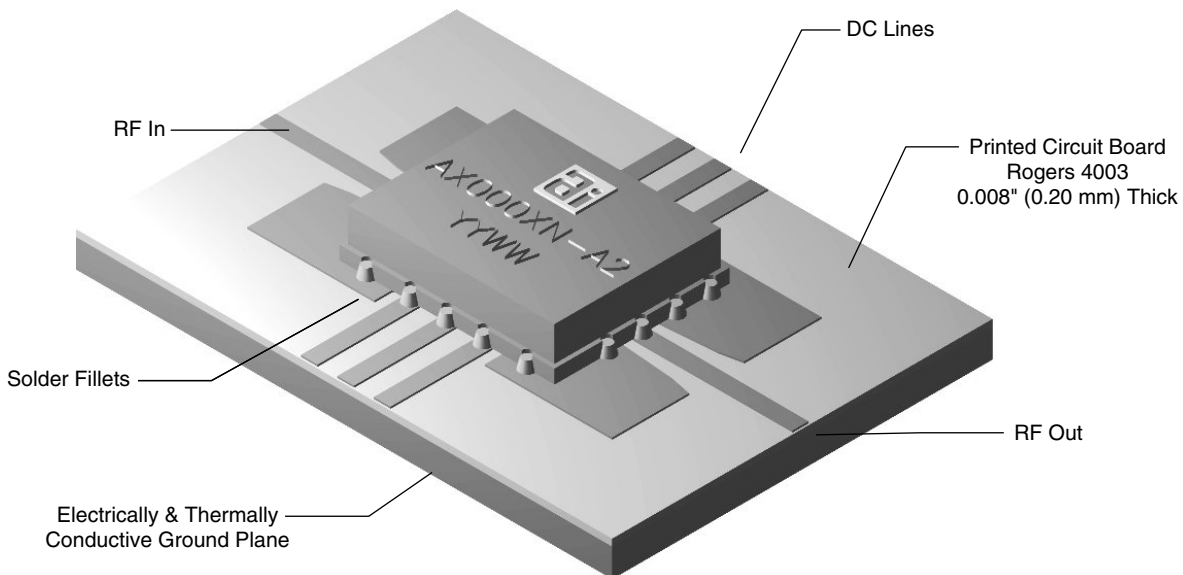

**Alpha Two Surface Mount Package Installation**