

FEATURES

- Frequency range 3.20MHz to 70.0MHz
- Fully RoHS compliant
- Two height profiles available, 4.8 or 3.8mm
- Standard EIA tape and reel supply

DESCRIPTION

MP24 and MP25 crystals provide an ideal source of low frequency clock signals (from 3.5MHz) in a low-profile SMD package. The part is electrically and mechanically compatible with traditional industry SMD packages and may be used as a 'drop-in' replacement.

USE WITH DOUBLE-SIDED PCBs

MP24 and MP25 crystals are designed for top board assembly and one solder reflow process. Do not reflow this part with the can inverted.

SPECIFICATION

Frequency Range	
AT-Cut Fundamental:	3.20MHz to 48.0MHz
AT-Cut 3rd Overtone:	27.0MHz to 70.0MHz
BT-Cut Fundamental:	24.0MHz to 48.0MHz
Calibration Tolerance at 25°C*:	from ±10ppm at 25°C (±30ppm standard)
Frequency stability	
AT-Cut from:	±10ppm over -10° to +60°C
BT-Cut from:	±50ppm over -10° to +60°C
Storage Temperature:	-40°~+85°C
Equivalent Series Resistance:	See table
Shunt Capacitance (C0):	7pF maximum
Load Capacitance (CL):	Series or from 8pF to 32pF (Customer specified CL)
Ageing:	< ±3ppm per year at +25°C
Drive level:	100µW typical, 500µW maximum
Reflow Soldering:	10s maximum at 260°C twice or 180s at 230°C, once.
Packaging:	24mm EIA tape and reel, 1k per.

EQUIVALENT SERIES RESISTANCE

Frequency Range MHz	ESR Ohms Max.
AT-Cut Fundamental	
3.2~3.4	300
3.5~6.0	120
6.1~10.0	60
10.1~48.0	40

Frequency Range MHz	ESR Ohms Max.
AT-Cut 3rd Overtone	
27.0~30.0	150
30.1~50.0	100
50.1~70.0	80

Frequency Range MHz	ESR Ohms Max.
BT-Cut Fundamental	
24.0~48.0	40



OUTLINE & DIMENSIONS

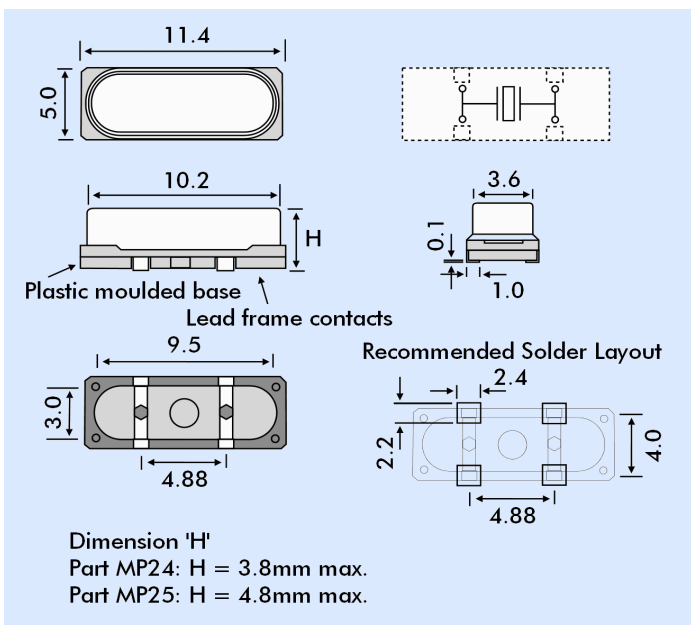

PART NUMBER GENERATION

Part numbers for MP24/25 crystals are generated as follows:

