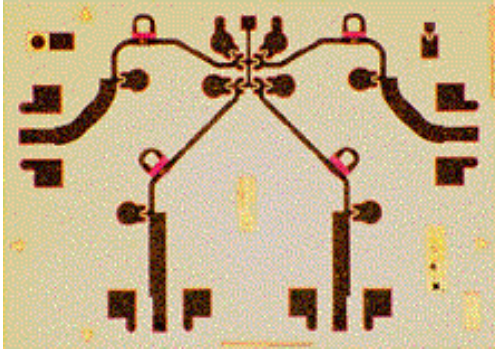

DC- 20 GHz SP4T PIN Switch**TGS2304-SCC****Key Features and Performance**

- DC to 20 GHz Frequency Range
- 0.6 dB Typical Midband Insertion Loss
- 38 dB Typical Midband Isolation
- Typical Input / Output SWR 1.2:1, Midband
- 23 dB Typical Input Power at 1 dB Gain Compression
- 2.540 x 3.556 x 0.1016 mm (0.100 x 0.140 x 0.004 in.)

Description

The TriQuint TGS2304-SCC is a GaAs monolithic PIN-diode single-pole, four-throw switch, in chip form, that operates from DC to 20 GHz. Each arm consists of one series and two shunt PIN diodes. At a bias current of 10 mA per RF output arm, typical midband insertion loss is 0.6 dB; midband return loss is approximately 20 dB. Typical isolation at 10 mA bias is 40 dB. Insertion loss and isolation can be adjusted by varying the switch arm bias currents.

Using a GaAs vertical PIN diode process, TriQuint has produced switches with high power handling capability, low on-state resistance, and low off-state capacitance. The higher cutoff frequency of the PIN diode element makes this switch ideal for broadband electronic components and communication systems wherein the MMIC construction offers reduced size, cost, and assembly time. Bond pad and backside metallization is gold plated for compatibility with eutectic alloy attach methods as well as thermocompression and thermosonic wire-bonding processes.

**TYPICAL
INSERTION
LOSS**

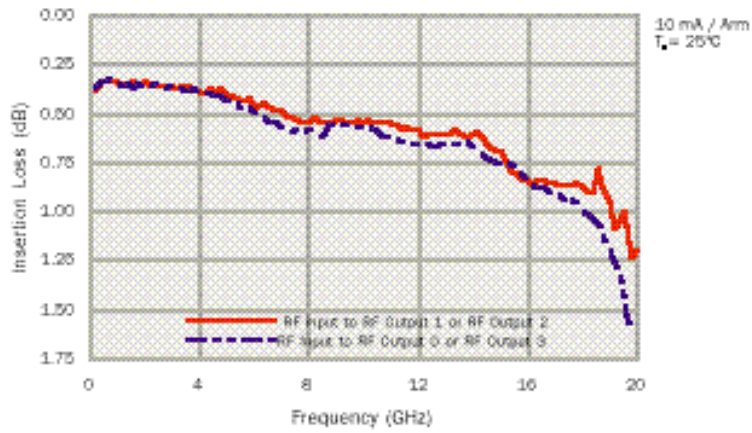

**TYPICAL
ISOLATION**

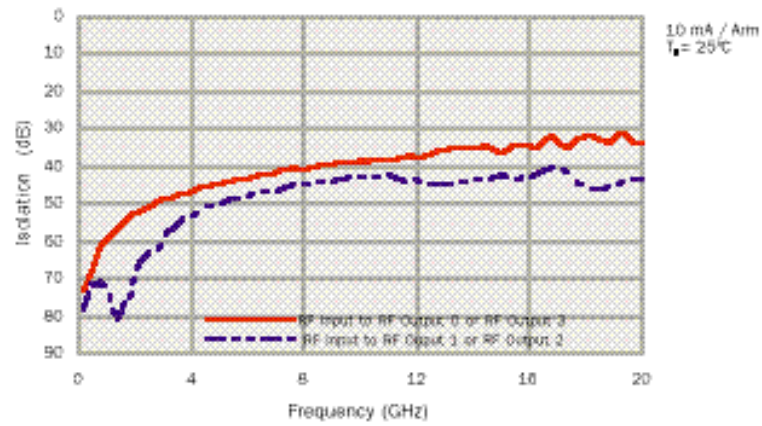

**TYPICAL
INPUT POWER
 P_{1dB}**

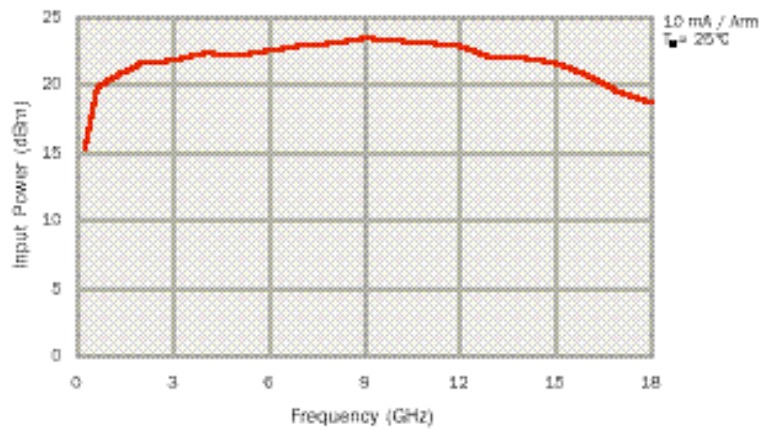

TYPICAL RETURN LOSS

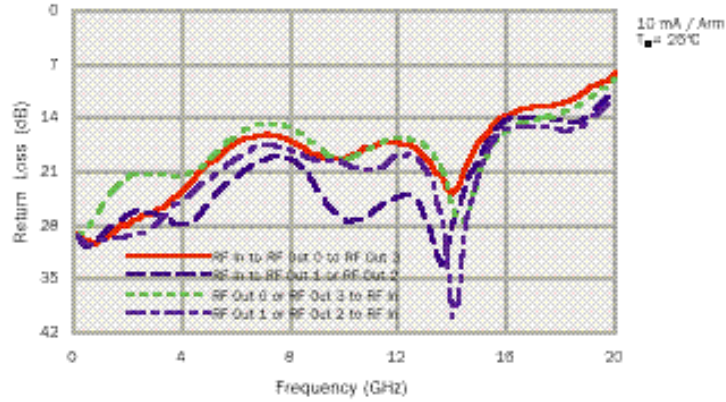

TYPICAL INSERTION LOSS VS. CONTROL BIAS CURRENT

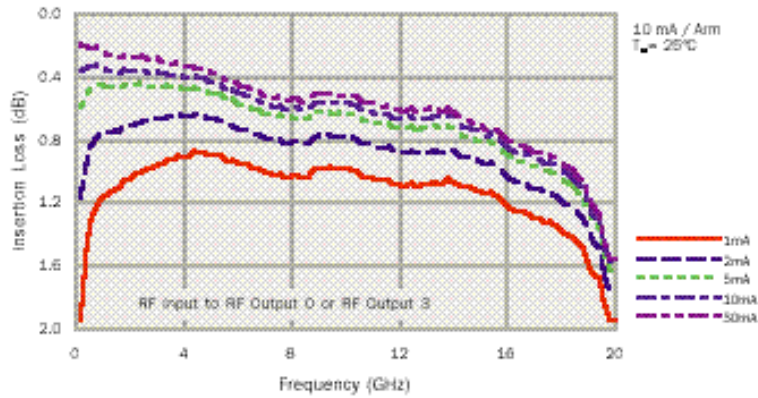

TYPICAL ISOLATION VS. CONTROL BIAS CURRENT

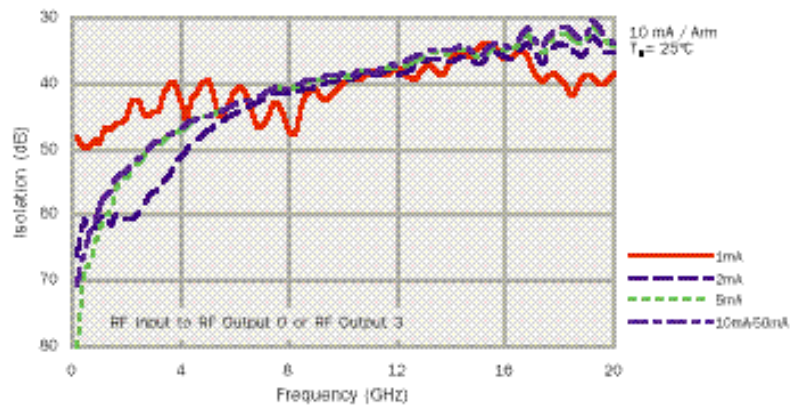

**TYPICAL INPUT
RETURN LOSS VS.
CONTROL BIAS
CURRENT**

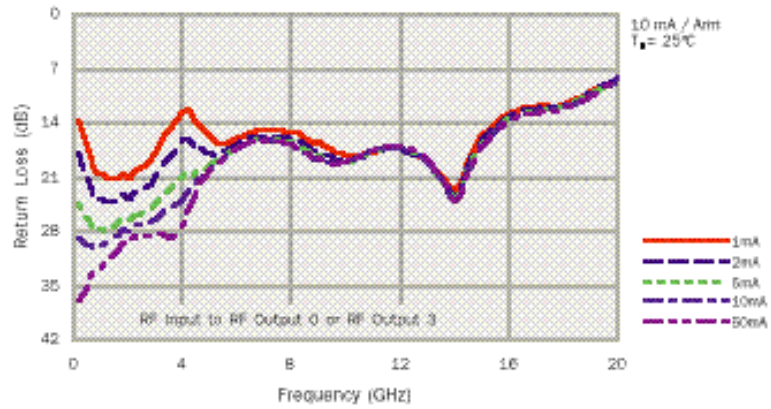

**TYPICAL OUTPUT
RETURN LOSS VS.
CONTROL BIAS
CURRENT**

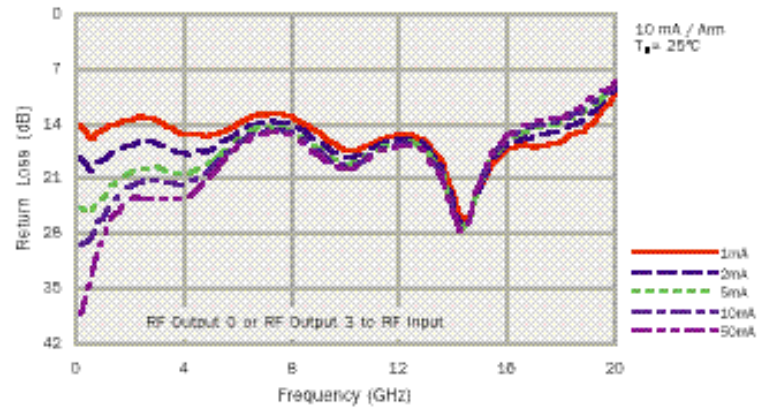

**TYPICAL INSERTION
LOSS VS. CONTROL
BIAS CURRENT**

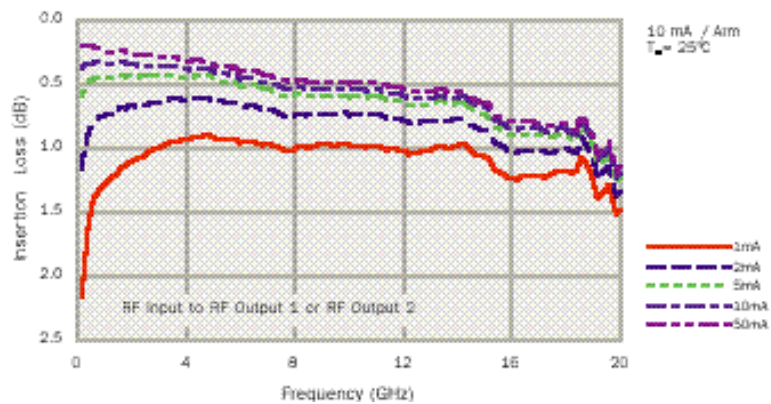

TYPICAL ISOLATION VS. CONTROL BIAS CURRENT

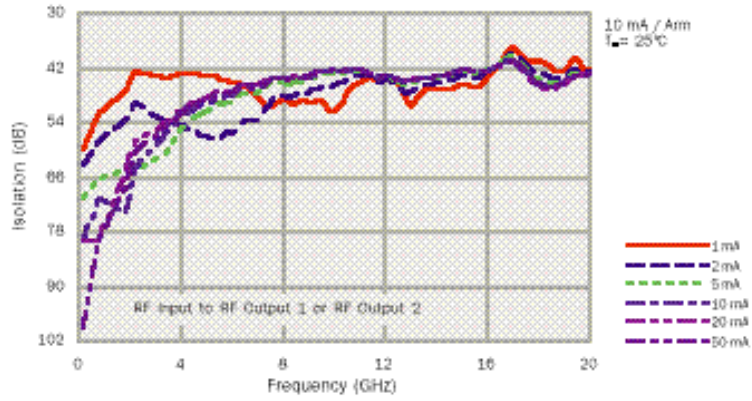

TYPICAL INPUT RETURN LOSS VS. CONTROL BIAS CURRENT

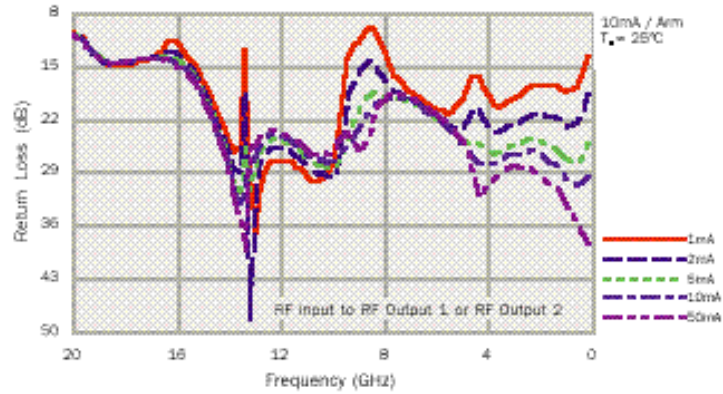

TYPICAL INPUT RETURN LOSS VS. CONTROL BIAS CURRENT

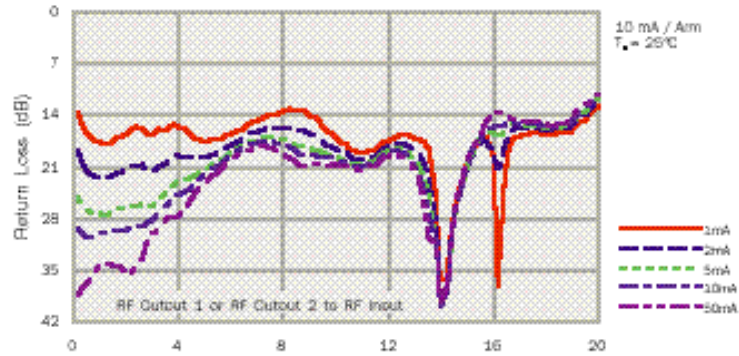

ABSOLUTE MAXIMUM RATINGS	Forward Voltage, V_F	2.5 V
	Forward Voltage, V_R	30 V
	Bias current.....	50 mA
	Input continuous wave power, P_{IN}	2 W
	Mounting temperature (30 sec.), T_M	320°C
	Storage temperature range, T_{STG}	-65 to 175°C

Ratings over operating channel temperature range, T_{CH} (unless otherwise noted).

Stresses beyond those listed under "Absolute Maximum Ratings" may cause permanent damage to the device. These are stress ratings only, and functional operation of the device at these or any other conditions beyond those indicated under "recommended operating conditions" is not implied. Exposure to absolute maximum rated conditions for extended periods may affect device reliability.

DC blocks are not provided at RF ports.

The operating junction temperature (T_J) will directly affect the device MTTF. For maximum life, it is recommended that junction temperature be maintained at the lowest possible level.

TYPICAL
S-PARAMETERS
(through path)
RF Input to RF output 3, 0

Frequency (GHz)	S ₁₁		S ₂₁		S ₁₂		S ₂₂		Insertion Loss (dB)
	MAG	ANG(°)	MAG	ANG(°)	MAG	ANG(°)	MAG	ANG(°)	
0.5	0.03	-36	0.962	-6	0.960	-6	0.04	-45	0.3
1.0	0.03	-63	0.963	-11	0.963	-11	0.05	-59	0.3
1.5	0.04	90	0.959	-17	0.961	-17	0.07	-65	0.4
2.0	0.04	-106	0.959	-23	0.959	-23	0.08	-69	0.4
2.5	0.05	-117	0.961	-28	0.958	-28	0.09	-74	0.3
3.0	0.05	-117	0.960	-34	0.959	-34	0.09	-82	0.4
3.5	0.06	-114	0.957	-40	0.957	-40	0.09	-94	0.4
4.0	0.07	-111	0.955	-46	0.954	-45	0.08	-110	0.4
4.5	0.08	-112	0.955	-51	0.953	-51	0.09	-129	0.4
5.0	0.10	-117	0.951	-57	0.951	-57	0.11	-143	0.4
5.5	0.12	-126	0.948	-63	0.948	-63	0.13	-152	0.5
6.0	0.14	-136	0.945	-69	0.946	-69	0.15	-159	0.5
6.5	0.15	-146	0.940	-75	0.941	-74	0.17	-164	0.5
7.0	0.15	-154	0.937	-80	0.937	-80	0.18	-167	0.6
7.5	0.15	-163	0.935	-86	0.933	-86	0.18	-171	0.6
8.0	0.15	-169	0.935	-91	0.932	-91	0.18	-175	0.6
8.5	0.13	-171	0.932	-97	0.933	-97	0.16	177	0.6
9.0	0.12	-166	0.938	-102	0.939	-102	0.14	169	0.6
9.5	0.11	-162	0.937	-108	0.936	-108	0.12	157	0.6
10.0	0.11	-158	0.937	-114	0.936	-114	0.11	142	0.6
10.5	0.12	-161	0.935	-120	0.933	-120	0.11	130	0.6
11.0	0.13	-167	0.932	-126	0.931	-126	0.13	120	0.6
11.5	0.14	-175	0.930	-132	0.929	-132	0.14	112	0.6
12.0	0.14	176	0.927	-138	0.924	-138	0.15	108	0.7
12.5	0.13	165	0.927	-144	0.926	-144	0.15	106	0.7
13.0	0.11	158	0.927	-150	0.926	-150	0.13	103	0.7
13.5	0.09	160	0.927	-156	0.926	-156	0.10	96	0.7
14.0	0.06	-171	0.926	-163	0.925	-163	0.06	75	0.7
14.5	0.10	-133	0.920	-169	0.919	-169	0.04	-4	0.7
15.0	0.15	-129	0.917	-175	0.915	-175	0.09	-44	0.8
15.5	0.18	-131	0.916	179	0.913	179	0.13	-57	0.8
16.0	0.21	-137	0.909	172	0.908	172	0.16	-63	0.8
16.5	0.23	-145	0.904	166	0.902	166	0.18	-68	0.9
17.0	0.24	-152	0.900	159	0.899	159	0.19	-72	0.9
17.5	0.24	-159	0.897	152	0.896	152	0.20	-77	0.9
18.0	0.25	-166	0.893	145	0.892	145	0.21	-87	1.0
18.5	0.27	-165	0.887	137	0.885	138	0.23	-104	1.0
19.0	0.31	-161	0.871	130	0.872	130	0.27	-124	1.2
19.5	0.34	-154	0.854	122	0.845	123	0.31	-143	1.4
20.0	0.39	-156	0.833	118	0.839	119	0.36	-156	1.6

T_A = 25°C, I = 10 mA

The reference planes for S-parameter data include bond wires as specified in the test assembly diagram. The S-parameters are also available on floppy disk and the world wide web.

TYPICAL
S-PARAMETERS
(isolated path)
RF Input to RF output 3

Frequency (GHz)	S ₁₁		S ₂₁		S ₁₂		S ₂₂		Isolation (dB)
	MAG	ANG(°)	MAG	ANG(°)	MAG	ANG(°)	MAG	ANG(°)	
0.5	0.06	15	0.0005	-87	0.0005	-75	0.90	177	66.3
1.0	0.06	-2	0.0011	-113	0.0011	-119	0.90	173	59.2
1.5	0.05	-22	0.0017	-132	0.0017	-129	0.88	169	55.2
2.0	0.04	-5	0.0023	-151	0.0023	-149	0.87	166	52.8
2.5	0.06	-52	0.0029	-160	0.0029	-162	0.87	163	50.8
3.0	0.02	-34	0.0037	-168	0.0037	-170	0.86	158	48.6
3.5	0.08	-57	0.0041	-180	0.0041	-180	0.87	153	47.7
4.0	0.07	-103	0.0046	175	0.0046	175	0.87	148	46.7
4.5	0.05	-95	0.0054	167	0.0054	168	0.88	144	45.4
5.0	0.08	-112	0.0058	163	0.0058	161	0.88	141	44.7
5.5	0.08	-131	0.0064	158	0.0064	157	0.88	138	43.9
6.0	0.07	-149	0.0070	154	0.0070	155	0.89	136	43.1
6.5	0.12	-140	0.0076	151	0.0076	150	0.88	133	42.4
7.0	0.13	173	0.0082	151	0.0082	150	0.88	129	41.7
7.5	0.05	-169	0.0095	143	0.0095	142	0.88	126	40.4
8.0	0.11	177	0.0092	140	0.0092	141	0.88	123	40.7
8.5	0.04	170	0.0103	138	0.0103	138	0.87	119	39.7
9.0	0.06	-153	0.0109	135	0.0109	135	0.87	114	39.3
9.5	0.08	-141	0.0115	130	0.0115	130	0.87	111	38.8
10.0	0.09	-164	0.0120	126	0.0120	126	0.87	107	38.4
10.5	0.10	-171	0.0123	127	0.0123	128	0.87	102	38.2
11.0	0.14	165	0.0123	124	0.0123	124	0.87	96	38.2
11.5	0.12	97	0.0134	126	0.0134	126	0.87	90	37.5
12.0	0.10	141	0.0132	123	0.0132	122	0.87	86	37.6
12.5	0.13	69	0.0153	125	0.0153	125	0.87	84	36.3
13.0	0.09	32	0.0167	120	0.0167	121	0.88	83	35.6
13.5	0.09	-42	0.0179	113	0.0179	113	0.87	82	34.9
14.0	0.09	-84	0.0178	109	0.0178	109	0.86	78	35.0
14.5	0.18	-78	0.0188	104	0.0188	102	0.86	73	34.5
15.0	0.22	-148	0.0159	102	0.0159	102	0.85	67	36.0
15.5	0.07	-79	0.0197	103	0.0197	104	0.86	62	34.1
16.0	0.22	-128	0.0188	95	0.0188	95	0.85	56	34.5
16.5	0.08	76	0.0220	101	0.0220	102	0.85	52	33.2
17.0	0.28	-97	0.0229	76	0.0229	76	0.85	48	32.8
17.5	0.08	-140	0.0197	89	0.0197	89	0.85	46	34.1
18.0	0.24	-90	0.0257	77	0.0257	77	0.86	43	31.8
18.5	0.40	-133	0.0238	61	0.0238	62	0.86	39	32.5
19.0	0.16	-156	0.0232	71	0.0232	72	0.85	31	32.7
19.5	0.51	-141	0.0247	44	0.0247	46	0.86	23	32.2
20.0	0.43	-164	0.0201	48	0.0201	48	0.83	18	33.9

T_A = 25°C, I = 10 mA

The reference planes for S-parameter data include bond wires as specified in the test assembly diagram. The S-parameters are also available on floppy disk and the world wide web.

TYPICAL
S-PARAMETERS
(through path)
RF Input to RF output 2, 1

Frequency (GHz)	S ₁₁		S ₂₁		S ₁₂		S ₂₂		Insertion Loss (dB)
	MAG	ANG(°)	MAG	ANG(°)	MAG	ANG(°)	MAG	ANG(°)	
0.5	0.03	-26	0.962	-6	0.964	-6	0.03	-33	0.3
1.0	0.03	-41	0.962	-12	0.963	-12	0.03	-49	0.3
1.5	0.04	-51	0.962	-18	0.963	-18	0.03	-61	0.3
2.0	0.05	-56	0.962	-24	0.962	-24	0.03	-72	0.3
2.5	0.05	-62	0.960	-29	0.960	-30	0.04	-81	0.4
3.0	0.05	-67	0.960	-35	0.959	-35	0.04	-86	0.4
3.5	0.04	-76	0.960	-41	0.957	-41	0.05	-91	0.4
4.0	0.04	-91	0.957	-48	0.957	-47	0.06	-99	0.4
4.5	0.04	-107	0.958	-53	0.956	-53	0.07	-109	0.4
5.0	0.06	-123	0.954	-59	0.954	-59	0.08	-123	0.4
5.5	0.07	-133	0.952	-65	0.952	-65	0.09	-136	0.4
6.0	0.08	-142	0.948	-71	0.951	-71	0.11	-147	0.5
6.5	0.10	-150	0.949	-77	0.945	-77	0.12	-157	0.5
7.0	0.11	-154	0.946	-83	0.946	-83	0.13	-166	0.5
7.5	0.11	-155	0.941	-89	0.944	-89	0.13	-176	0.5
8.0	0.11	-158	0.940	-95	0.940	-95	0.13	176	0.5
8.5	0.09	-164	0.940	-101	0.940	-101	0.12	172	0.5
9.0	0.07	-175	0.941	-106	0.940	-106	0.11	178	0.5
9.5	0.05	162	0.940	-112	0.939	-112	0.11	-176	0.5
10.0	0.04	144	0.939	-118	0.937	-118	0.10	-175	0.5
10.5	0.04	143	0.939	-124	0.940	-124	0.10	178	0.5
11.0	0.05	146	0.940	-130	0.938	-130	0.09	165	0.5
11.5	0.06	133	0.936	-136	0.939	-137	0.10	156	0.6
12.0	0.06	110	0.935	-143	0.935	-143	0.11	155	0.6
12.5	0.06	95	0.933	-149	0.933	-149	0.11	152	0.6
13.0	0.05	92	0.933	-155	0.932	-155	0.10	145	0.6
13.5	0.02	139	0.934	-161	0.932	-161	0.05	128	0.6
14.0	0.04	-143	0.933	-167	0.932	-167	0.01	66	0.6
14.5	0.07	-113	0.928	-174	0.931	-174	0.04	-84	0.6
15.0	0.11	-93	0.924	180	0.921	180	0.09	-111	0.7
15.5	0.16	-90	0.912	174	0.914	174	0.14	-123	0.8
16.0	0.19	-94	0.908	168	0.907	168	0.17	-130	0.8
16.5	0.20	-103	0.908	161	0.907	161	0.18	-129	0.8
17.0	0.21	-108	0.907	154	0.908	155	0.18	-133	0.8
17.5	0.20	-113	0.905	148	0.907	148	0.18	-138	0.9
18.0	0.20	-122	0.906	141	0.907	141	0.17	-143	0.9
18.5	0.19	-142	0.909	135	0.904	134	0.17	-133	0.8
19.0	0.21	-167	0.896	127	0.900	127	0.19	-125	1.0
19.5	0.25	-178	0.891	120	0.883	120	0.22	-130	1.0
20.0	0.30	-174	0.871	113	0.882	114	0.26	-151	1.2

T_A = 25°C, I = 10 mA

The reference planes for S-parameter data include bond wires as specified in the test assembly diagram. The S-parameters are also available on floppy disk and the world wide web.

TYPICAL
S-PARAMETERS
(isolated path)
RF Input to RF output 2, 1

Frequency (GHz)	S ₁₁		S ₂₁		S ₁₂		S ₂₂		Isolation (dB)
	MAG	ANG(°)	MAG	ANG(°)	MAG	ANG(°)	MAG	ANG(°)	
0.5	0.06	10	0.0003	127	0.0003	59	0.90	177	70.3
1.0	0.06	-35	0.0002	98	0.0002	48	0.90	173	74.0
1.5	0.08	-69	0.0001	-70	0.0001	-112	0.89	169	79.3
2.0	0.07	-80	0.0004	147	0.0004	159	0.88	165	68.0
2.5	0.12	-88	0.0007	156	0.0007	161	0.87	162	63.1
3.0	0.06	-102	0.0011	163	0.0011	161	0.87	158	59.2
3.5	0.09	-77	0.0017	155	0.0017	149	0.87	155	55.4
4.0	0.09	-106	0.0022	145	0.0022	140	0.87	151	53.2
4.5	0.07	-102	0.0029	138	0.0029	139	0.88	147	50.9
5.0	0.11	-117	0.0032	130	0.0032	130	0.88	143	49.9
5.5	0.13	-135	0.0036	124	0.0036	123	0.88	140	48.8
6.0	0.12	-150	0.0040	120	0.0040	120	0.89	137	48.0
6.5	0.16	-141	0.0048	115	0.0048	113	0.89	134	46.4
7.0	0.18	-172	0.0047	108	0.0047	110	0.89	132	46.6
7.5	0.12	-155	0.0059	109	0.0059	108	0.89	128	44.6
8.0	0.19	-169	0.0059	93	0.0059	94	0.88	124	44.6
8.5	0.10	-177	0.0061	91	0.0061	91	0.89	121	44.3
9.0	0.10	-156	0.0062	90	0.0062	90	0.88	118	44.2
9.5	0.10	-139	0.0072	86	0.0072	85	0.88	115	42.9
10.0	0.12	-148	0.0075	77	0.0075	76	0.88	111	42.5
10.5	0.15	-150	0.0073	70	0.0073	70	0.87	107	42.7
11.0	0.21	-170	0.0076	59	0.0076	61	0.88	103	42.4
11.5	0.14	151	0.0066	47	0.0066	48	0.88	101	43.6
12.0	0.18	172	0.0067	51	0.0067	53	0.89	100	43.5
12.5	0.13	122	0.0059	44	0.0059	44	0.88	98	44.5
13.0	0.07	115	0.0057	44	0.0057	44	0.89	94	44.9
13.5	0.03	-134	0.0061	43	0.0061	43	0.87	88	44.3
14.0	0.11	-145	0.0065	38	0.0065	39	0.88	81	43.7
14.5	0.15	-112	0.0066	35	0.0066	34	0.87	76	43.6
15.0	0.31	-152	0.0077	28	0.0077	27	0.87	72	42.3
15.5	0.12	-153	0.0070	20	0.0070	20	0.85	71	43.1
16.0	0.28	-141	0.0075	22	0.0075	22	0.87	66	42.5
16.5	0.17	139	0.0086	14	0.0086	13	0.85	64	41.3
17.0	0.26	-108	0.0102	-5	0.0102	-5	0.87	62	39.8
17.5	0.18	-178	0.0073	-25	0.0073	-24	0.87	63	42.7
18.0	0.20	-110	0.0057	-22	0.0057	-24	0.87	59	44.9
18.5	0.39	-143	0.0050	-20	0.0050	-18	0.88	52	46.1
19.0	0.27	173	0.0055	-14	0.0055	-16	0.86	39	45.2
19.5	0.55	-160	0.0065	-23	0.0065	-27	0.89	29	43.7
20.0	0.55	178	0.0070	-28	0.0070	-29	0.85	27	43.1

T_A = 25°C, I = 10 mA

The reference planes for S-parameter data include bond wires as specified in the test assembly diagram. The S-parameters are also available on floppy disk and the world wide web.

RF CHARACTERISTICS

PARAMETER		TEST CONDITIONS	TYP
IL	Insertion loss	Midband	0.6
ISO	Isolation	Midband	38
SWR(in)	Input standing-wave ratio	Midband	1.2:1
SWR(out)	Output standing-wave ratio	Through selected output arm, midband	1.2:1
$P_{1dB(in)}$	Input power at 1-dB gain compression		23

$T_A = 25^\circ\text{C}$

EQUIVALENT SCHEMATIC

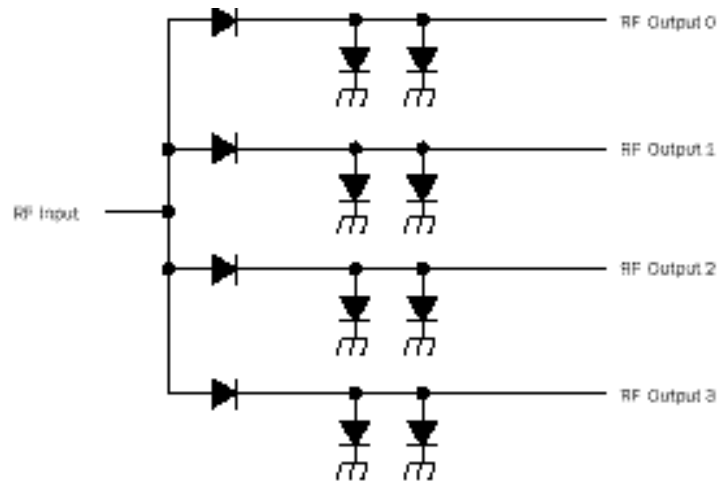

RECOMMENDED TEST CONFIGURATION

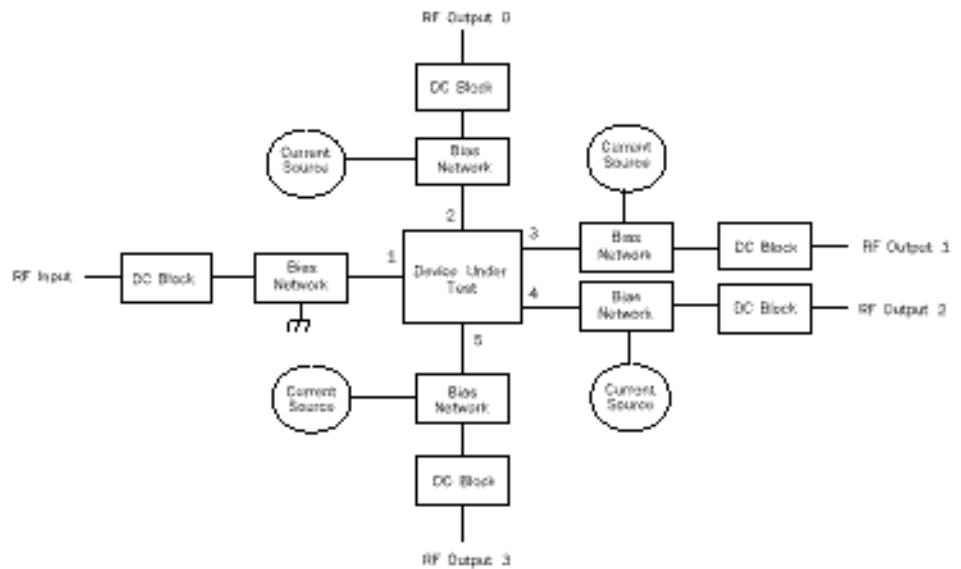

DC blocks are not provided at RF ports.

FUNCTION TABLE

LOW-LOSS PATH	RF INPUT	RF OUTPUT 0	RF OUTPUT 1	RF OUTPUT 2	RF OUTPUT 3
RF Input to RF Output 0	0 V	-10 mA	10 mA	10 mA	10 mA
RF Input to RF Output 1	0 V	10 mA	-10 mA	10 mA	10 mA
RF Input to RF Output 2	0 V	10 mA	10 mA	-10 mA	10 mA
RF Input to RF Output 3	0 V	10 mA	10 mA	10 mA	-10 mA

**TEST ASSEMBLY
DIAGRAM**

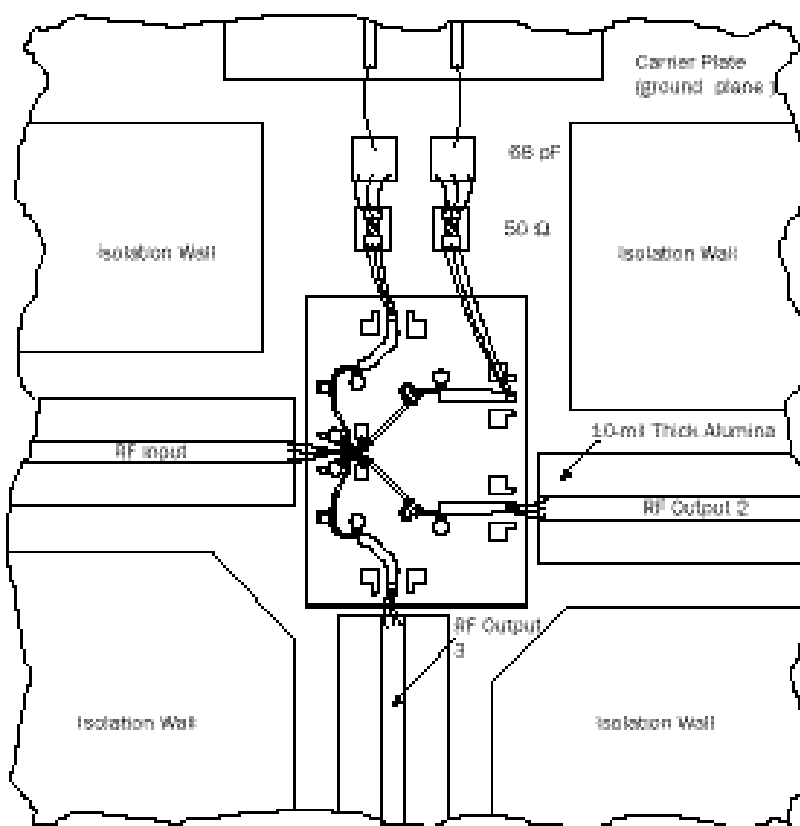

RF connections: bond using three 1.0-mil diameter, 20 to 25-mil-length gold bond wires at both RF Input and RF Output for optimum RF performance.

Close placement of external components is essential for resonant-free performance.

Refer to TriQuint's Gallium Arsenide Products Designer's Information, MMIC Assembly Procedures, on our web site.

**MECHANICAL
DRAWING**

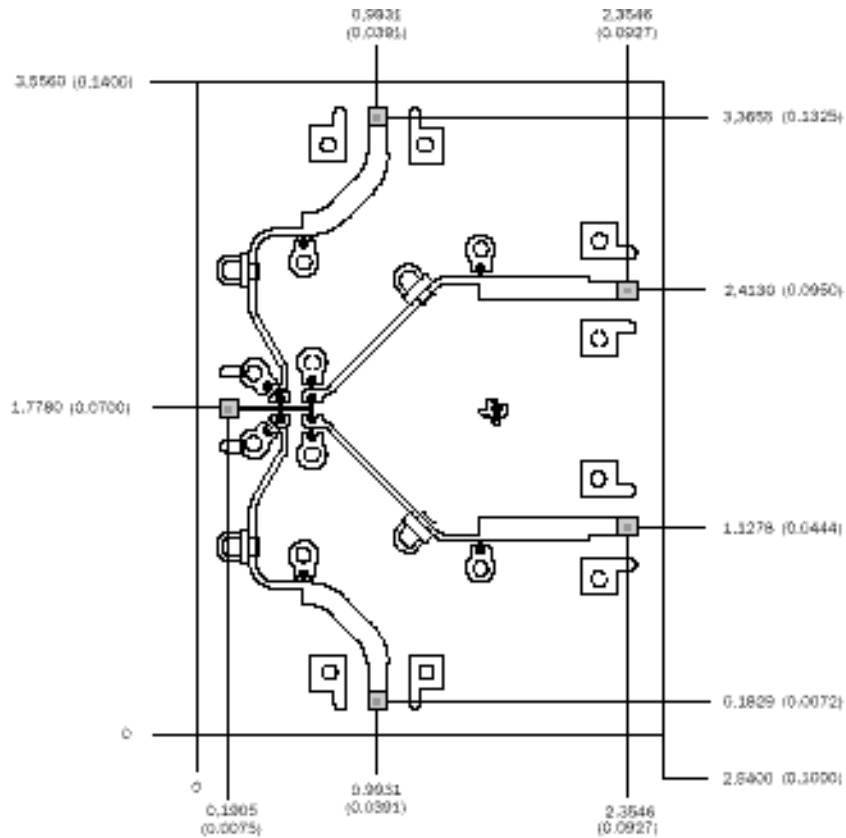

Units: millimeters (inches)

Thickness: 0,1016 (0.0040) (reference only)

Chip edge to bond pad dimensions are shown to center of bond pad.

Chip size tolerance: ± 0,0508 (0.0020)

Bond pad #1 (RF Input):	0,1016 x 0,1016 (0.004 x 0.004)
Bond pad #2 (RF Output 0):	0,1016 x 0,1016 (0.004 x 0.004)
Bond pad #3 (RF Output 1):	0,1016 x 0,1016 (0.004 x 0.004)
Bond pad #4 (RF Output 2):	0,1016 x 0,1016 (0.004 x 0.004)
Bond pad #5 (RF Output 3):	0,1016 x 0,1016 (0.004 x 0.004)

Application Notes: Driver Circuit for 2300 Series GaAs PIN Diode Switches

INTRODUCTION

This section describes how a single 5 V power supply and a 74F240N line driver are used in a driver circuit for the TGS2304 PIN-diode switch. The PIN switch must be mounted on a silicon MOS capacitor (MOSCAP or equivalent) of approximately 1000 pF (see Mounting Diagram, page 15). Eight separate drivers are provided in a single 'F240 DIP (see Driver Circuit, page 15). In addition, the 'F240 can be set to provide an inverted or a non-inverted output. The inverted is preferred in this application because it allows the 1G pin to be tied to ground instead of 5 V, eliminating the use of an extra power supply. The 74BCT240, 74BCT240N, and 74S240N also work with this driver circuit.

CONNECTION INSTRUCTIONS

The Interface Schematic (see page 16) shows a voltage divider that can be used to provide approximately 2 V to the RF Input (common) port of the TGS2304-SCC. This bias voltage should be connected to the RF Input through a bias tee or some equivalent RF choke/DC block network.

Connect this same bias voltage to the top plate of the MOSCAP through a ~3-nH coil bonded to MMIC ground pad as shown in the Interface Schematic and RF Input Bias Coil Assembly (both on page 16). Care should be taken not to bond the inductor close to the via, as this could result in device damage. The ground pad is connected to the backside of the TGS2304-SCC by plated-through vias. This sets the top plate of the MOSCAP to 2 V, effectively providing a 2 V reference for the RF input port and the cathodes of the two shunt diodes in each arm. The bottom plate of the MOSCAP is true DC ground.

Connect the four RF Output ports of the TGS2304-SCC to the 'F240 outputs through a bias tee or some equivalent RF choke/DC block, as shown in the Interface Schematic on page 16.

OPERATING INSTRUCTIONS

For proper switch operation, only one arm should be turned on at any one time as shown in the Control Logic Table on page 15. The following description of how the driver circuit controls one arm of the TGS2304-SCC applies to all arms.

To turn an arm on: A TTL high at the 'F240 input results in approximately 0.3 V at the corresponding output. This is applied to the appropriate RF Output port. Since the RF Input port of the TGS2304-SCC is at 2 V, the arm is turned on. The series diode in that arm is forward biased by approximately 1.7 V, and the two shunt diodes are reverse biased (off) by 1.7 V. Under these conditions, the bias current is typically 12 mA and midband insertion loss is typically 0.9 dB.

To turn an arm off: A TTL low at the 'F240 input results in approximately 3.1 V at the corresponding output. This is applied to the appropriate RF Output port. Since the RF Input port of the TGS2304-SCC is at 2 V, the arm is turned off. The series diode in that arm is reverse biased by approximately 1.1 V, and the shunt diodes in that arm are forward biased (on) by 1.1 V. Under these conditions, the bias current is typically 9 mA and the midband isolation is typically 40 dB.

CONTROL LOGIC TABLE

	DRIVER VOLTAGE APPLIED AT R _i				RF SWITCH ARMS			
	0	1	2	3	0	1	2	3
TGS2304-SCC	L	H	H	H	ON	OFF	OFF	OFF
	H	L	H	H	OFF	ON	OFF	OFF
	H	H	L	H	OFF	OFF	ON	OFF
	H	H	H	L	OFF	OFF	OFF	ON
	H	H	H	H	ON	ON	ON	ON

L = low (typically 0.3 V), H = high (typically 3.1 V)

MOUNTING DIAGRAM

It is recommended that the Si MOSCAP be 10-mils larger than the Gate MMIC in length and width.



Attached with AuSn Solder or Conductive Epoxy

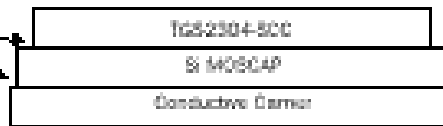

DRIVER CIRCUIT

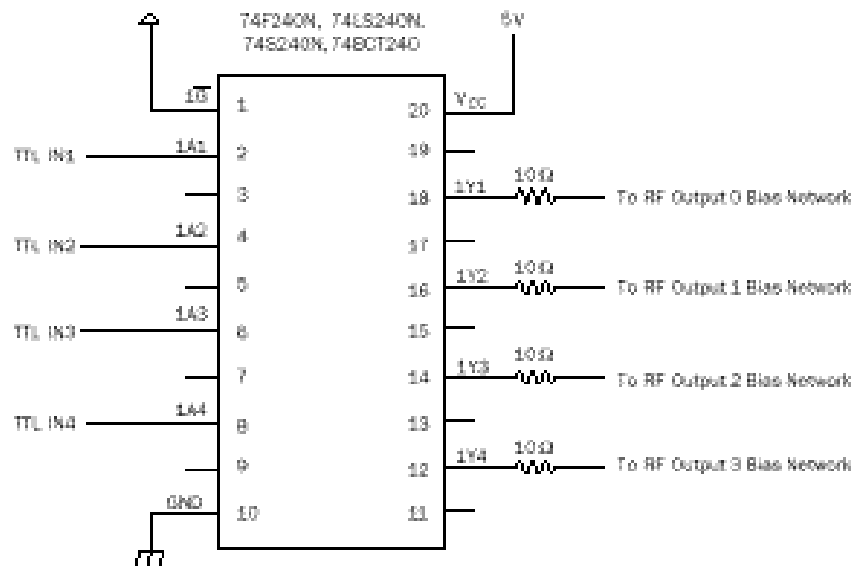

INTERFACE SCHEMATIC

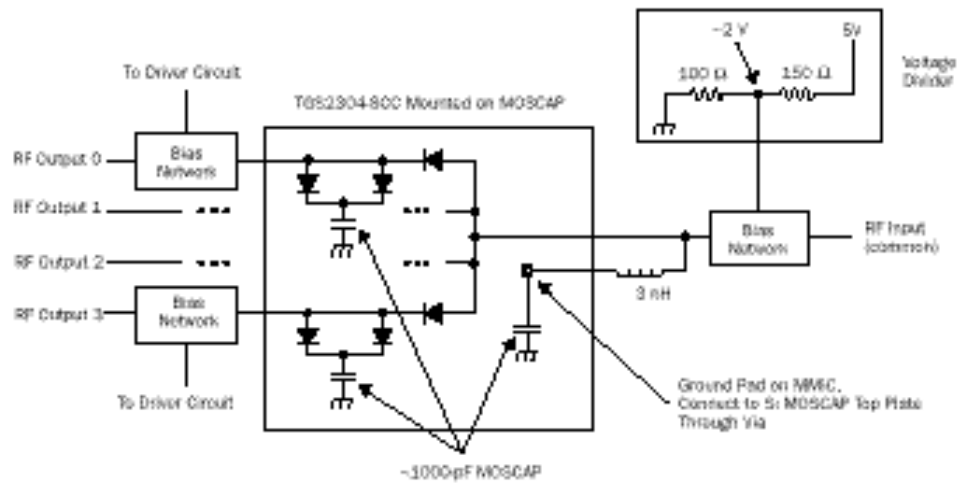

RF INPUT BIAS COIL ASSEMBLY

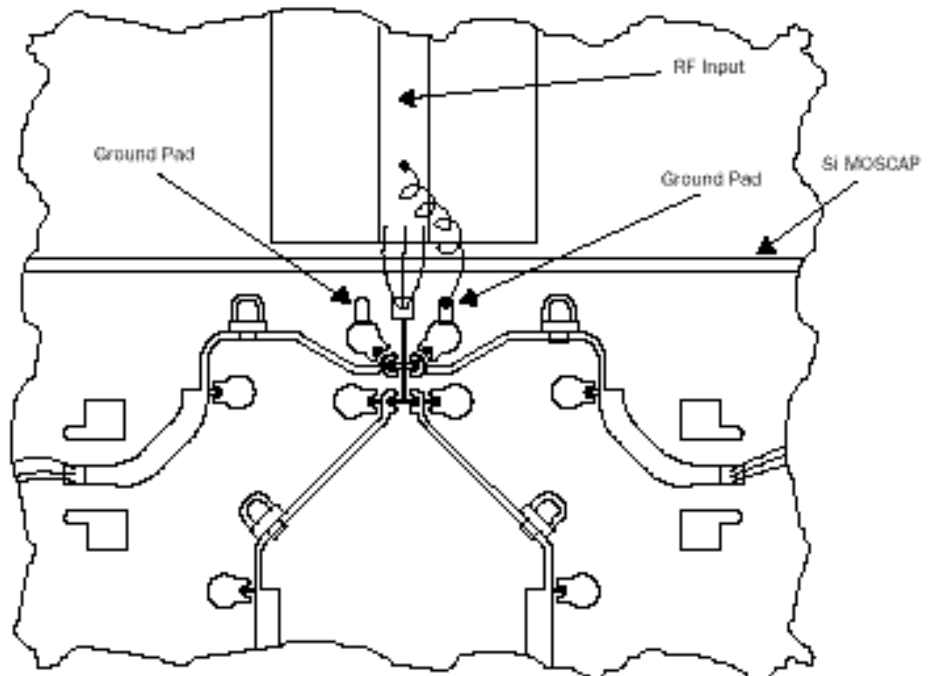

GaAs MMIC devices are susceptible to damage from Electrostatic Discharge. Proper precautions should be observed during handling, assembly and test.