

## Ultra Rapid Semiconductor Protection Fuse American Square Body Type Fuses













**American End Contacts  
Voltage Ratings 450V to 700V  
Current Ratings 63A to 2500A  
Sizes 0, 1, 2, 3**













### **Key Features:**

- ❖ 690V voltage rating complying with IEC, DIN and VDE standards
- ❖ Exceptionally low  $I^2t$ , power losses
- ❖ Non Magnetic construction, highly reliable low voltage indicator system
- ❖ Conform to UL, IEC, DIN and VDE standards
- ❖ Increased technical performance give higher ratings and a reduction in volume and weight
- ❖ All models with integrated trip-indicator
- ❖ Microswitch system reference MS 3V 1-5









Main Characteristics:

Size	Voltage U <sub>N</sub> (V)	Ref:		Current rating I <sub>N</sub> (A)	Pre-arcing I <sup>2</sup> t @ 1 ms I <sup>2</sup> t <sub>p</sub> (kA <sup>2</sup> s)	Total Clearing I <sup>2</sup> t @ U <sub>N</sub> (kA <sup>2</sup> s)	Watt Losses		Tested Interrupting rating
							0.8I <sub>N</sub>	I <sub>N</sub>	
0	700V	070US0U0063B		63	0.20	1.10	7.5	14	170kA / 700V
		070US0U0080B		80	0.33	1.8	9.5	19	
		070US0U0100B		100	0.47	2.5	13	26	
		070US0U0125B		125	0.85	4.5	15	30	
		070US0U0160B		160	1.6	8.5	18.5	37	
		070US0U0200B		200	3	15.5	21.5	42	
		070US0U0250B		250	5.8	30	25	48	
		070US0U0315B		315	12	62	22.5	53	
		070US0U0350B		350	15.5	80	30	57	
		070US0U0400B		400	23	120	32.5	60	
		070US0U0450B		450	26	150	44	80	
		070US0U0500B		500	41	240	44	80	
		070US0U0550B	-	550	52	300	45	80	











Notes: Minimum operating voltage for integrated trip indicator = 20V. Micro switch reference: MS 3V 1-5  
 Shaded data; not included on curves, refer to factory.

Size	Voltage U <sub>N</sub> (V)	Ref:		Current rating I <sub>N</sub> (A)	Pre-arcing I <sup>2</sup> t @ 1 ms I <sup>2</sup> t <sub>p</sub> (kA <sup>2</sup> s)	Total Clearing I <sup>2</sup> t @ U <sub>N</sub> (kA <sup>2</sup> s)	Watt Losses		Tested Interrupting rating
							0.8I <sub>N</sub>	I <sub>N</sub>	
1	700V	070US1U0200B		200	2.60	13.50	22.5	45	170kA / 700V
		070US1U0250B		250	4.70	25.00	25.5	52	
		070US1U0315B		315	7.50	40.00	32.5	65	
		070US1U0350B		350	10.50	55.00	33.5	67	
		070US1U0400B		400	19.00	100.00	34.0	68	
		070US1U0450B		450	26.50	140.00	35.0	70	
		070US1U0500B		500	37.00	195.00	36.0	70	
		070US1U0550B		550	52.00	280.00	37.5	70	
		070US1U0630B		630	75.00	390.00	42.5	75	
		070US1U0700B		700	95.00	490.00	42.5	85	
		070US1U0800B		800	140.00	800.00	60.0	105	

Notes: Minimum operating voltage for integrated trip indicator = 20V. Micro switch reference: MS 3V 1-5  
 Shaded data; not included on curves, refer to factory.

Size	Voltage U <sub>N</sub> (V)	Ref:		Current rating I <sub>N</sub> (A)	Pre-arcing I <sup>2</sup> <sub>t</sub> @ 1 ms I <sup>2</sup> <sub>tp</sub> (kA <sup>2</sup> s)	Total Clearing I <sup>2</sup> <sub>t</sub> @ U <sub>N</sub> (kA <sup>2</sup> s)	Watt Losses		Tested Interrupting rating
							0.8I <sub>N</sub>	I <sub>N</sub>	
2	700V	070US2U0400B		400	15	80	32.5	75	170 kA / 700V
		070US2U0450B		450	20	115	40	80	
		070US2U0500B		500	28	145	45	90	
		070US2U0550B		550	37	195	47.5	95	
		070US2U0630B		630	54	280	52.5	105	
		070US2U0700B		700	76	400	55	110	
		070US2U0800B		800	115	600	60	120	
	690V +6%	070US2U0900B		900	170	900	62.5	125	200 kA / 700V
		070US2U1000B		1000	240	1250	67.5	135	
	650V	065US2U1100B		1100	270	1670		165	160kA @ 650V
	600V	060US2U1250B		1250	410	2400		180	150kA @ 600V
	550V	055US2U1400B		1400	555	3400		190	130kA @ 550V
		055US2U1600B		1600	870	5300		195	
500V	050US2U1800B		1800	1050	8700		230	110kA @ 500V	

Notes: Minimum operating voltage for integrated trip indicator = 20V. Micro switch reference: MS 3V 1-5  
 Shaded data; not included on curves, refer to factory.

Size	Voltage U <sub>N</sub> (V)	Ref:		Current rating I <sub>N</sub> (A)	Pre-arcing I <sup>2</sup> <sub>t</sub> @ 1 ms I <sup>2</sup> <sub>tp</sub> (kA <sup>2</sup> s)	Total Clearing I <sup>2</sup> <sub>t</sub> @ U <sub>N</sub> (kA <sup>2</sup> s)	Watt Losses		Tested Interrupting rating
							0.8I <sub>N</sub>	I <sub>N</sub>	
3	700V	070US3U0500B		500	19	100	52.5	105	170 kA / 700V
		070US3U0550B		550	27	140	55	105	
		070US3U0630B		630	40	210	60	110	
		070US3U0700B		700	55	300	62.5	115	
		070US3U0800B		800	95	490	65	120	
		070US3U0900B		900	135	700	67.5	120	
		070US3U1000B		1000	170	900	77.5	135	
		070US3U1100B		1100	240	1260	80	135	
	690V +6%	070US3U1250B		1250	350	1850	90	150	200 kA / 700V
		070US3U1400B		1400	480	2400	100	160	
	650V	065US3U1600B	-	1600	555	2900	120	210	160kA @ 650V
		065US3U1800B		1800	720	3870	-	225	
	600V	060US3U2000B		2000	950	4800	-	250	150kA @ 600V
	550V	055US3U2250B		2250	1250	5160	-	280	130kA @ 550V
	500V	050US3U2500B		2500	1870	6540	-	280	110kA @ 500V

Notes: Minimum operating voltage for integrated trip indicator = 20V. Micro switch reference: MS 3V 1-5  
 Shaded data; not included on curves, refer to factory.

**Electrical Characteristics:**

**Times vs current characteristics**

The curves shown on page 4 indicate the pre-arcing time for each rated current as a function of RMS value of pre-arcing current I:

- Tolerances on this current ± 8%
- Beyond 30 sec or 10 sec, small overloads must be eliminated by another device.

Curve CC' represents the maximum times taken by the associated device to clear small overloads; only its horizontal line is represented.

Its oblique line must be plotted according to sketch in top right corner:

- The intersection of the fuse and CC' curves indicates the minimum breaking current  $I_{pm}$  of the fuse.

Size 0

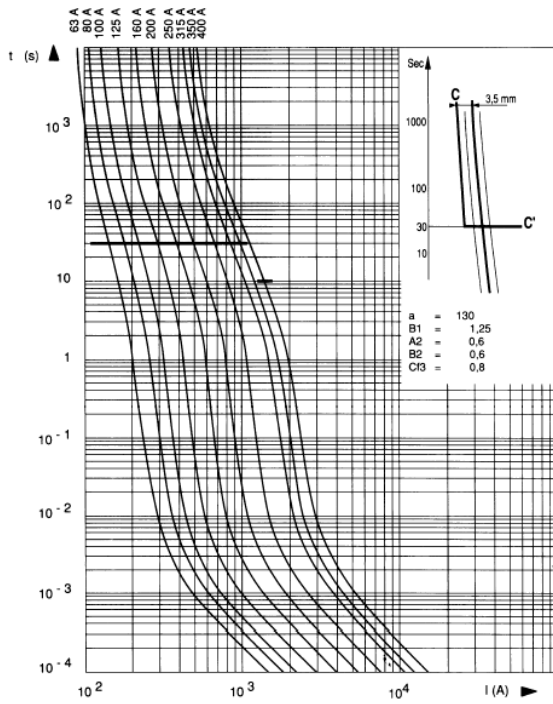

Size 1

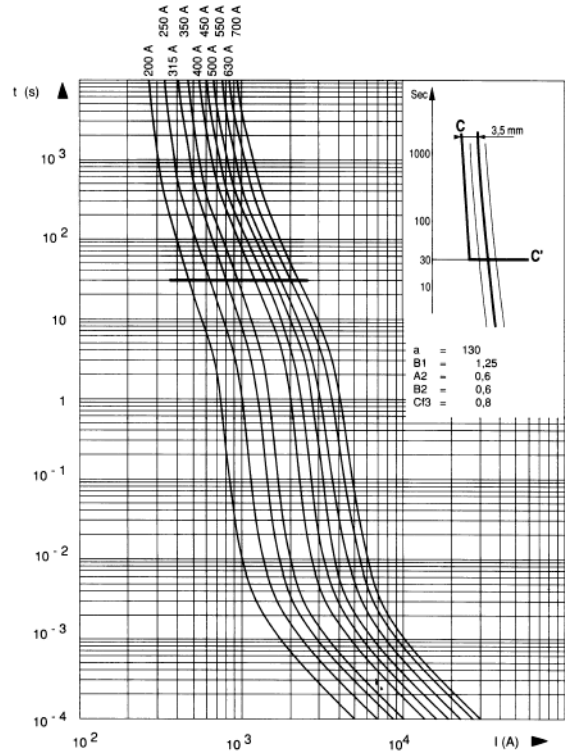

Size 2

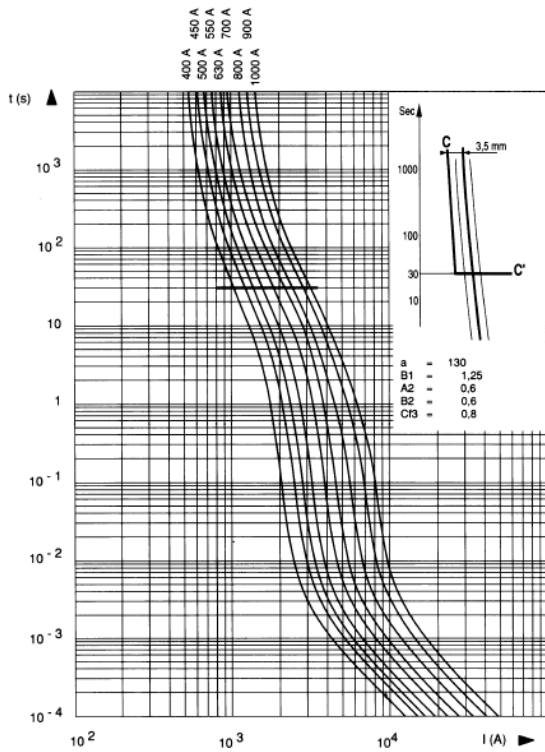

Size 3

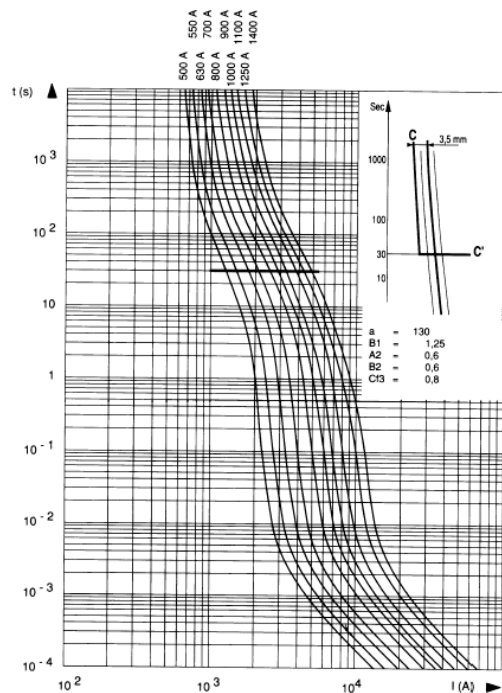

**Total clearing I<sup>2</sup>T:**

The horizontal curves given below indicated the maximum values of total operating I<sup>2</sup>t (I<sup>2</sup>t<sub>t</sub>) as a function of prospective current I<sub>p</sub> @ 660V, cosφ = 0.15. Oblique lines indicate the corresponding total operating time T<sub>t</sub>, with pre-arcing time in brackets.

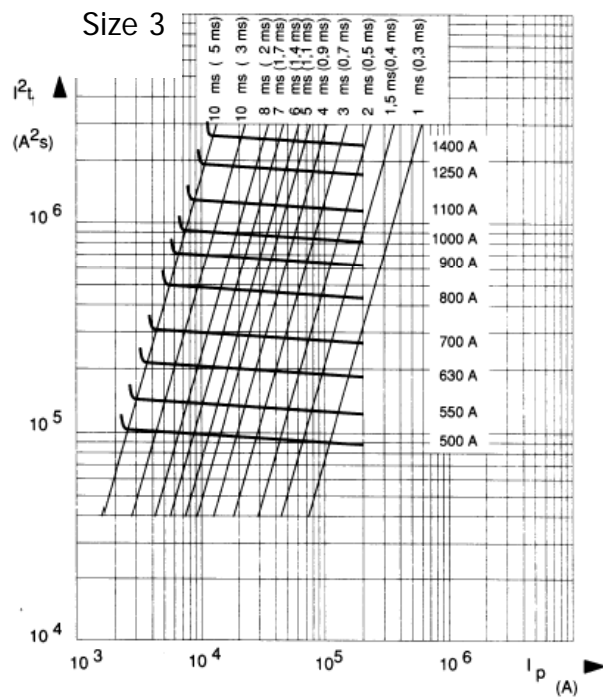
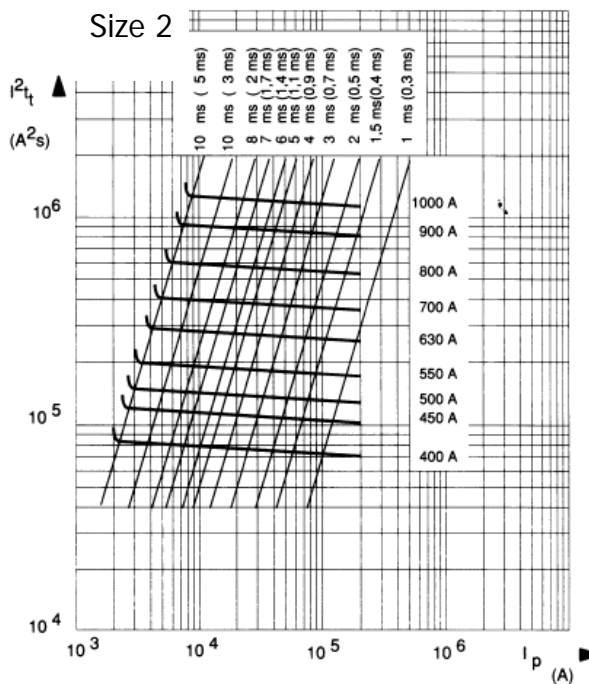
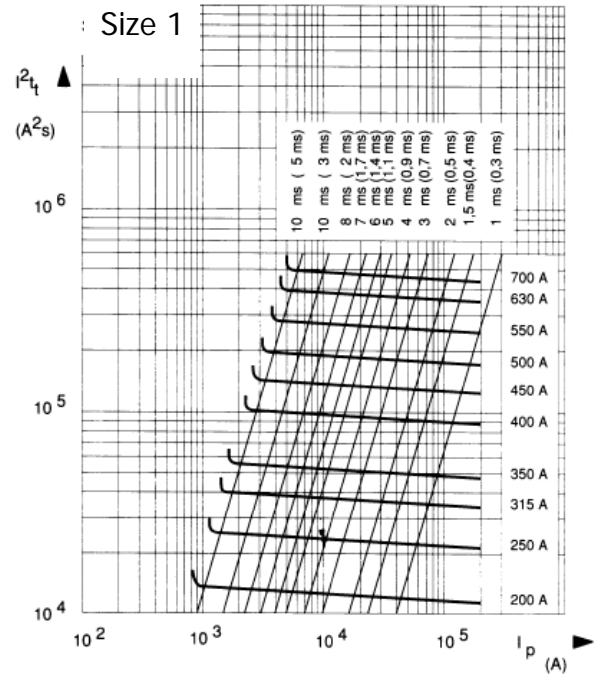
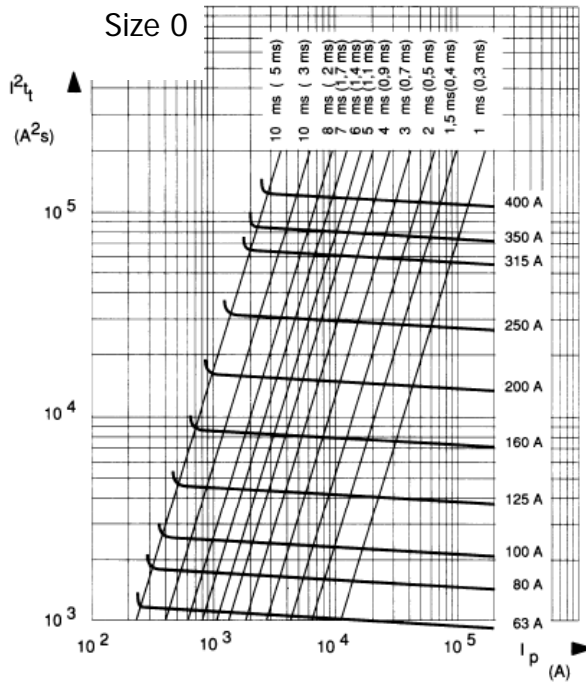

**Cut off Characteristics:**

The curves below indicate, for each rated current, the peak value  $I_c$  that the current may reach as a function of the prospective fault current  $I_p$ .

Size 0

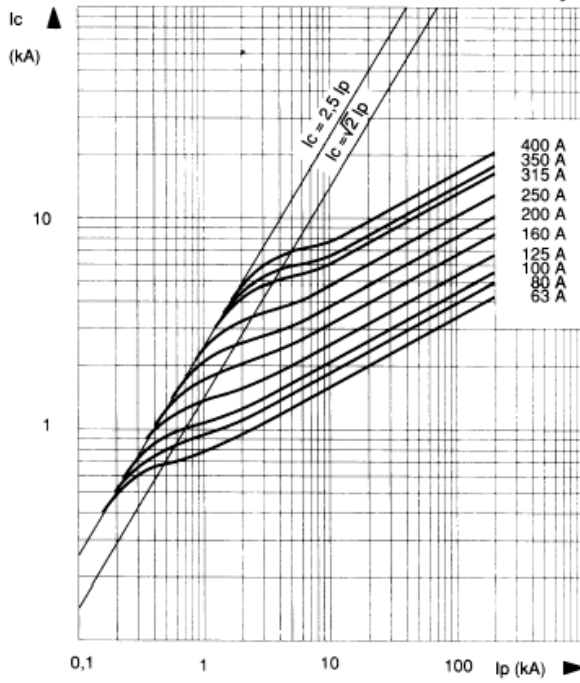

Size 1

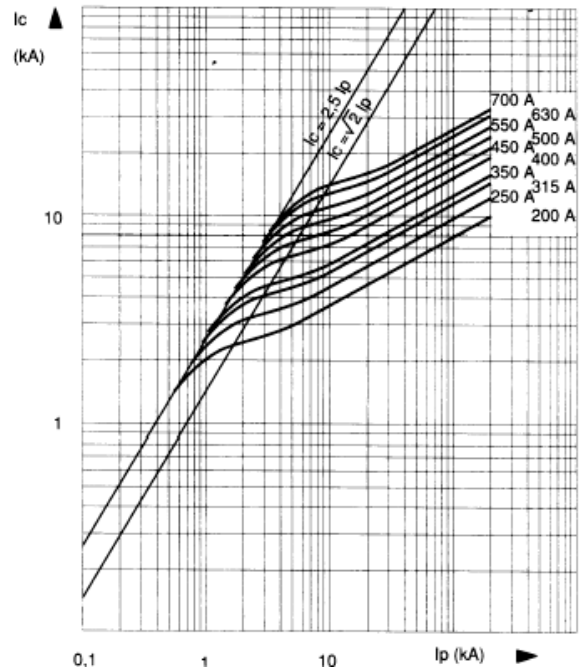

Size 2

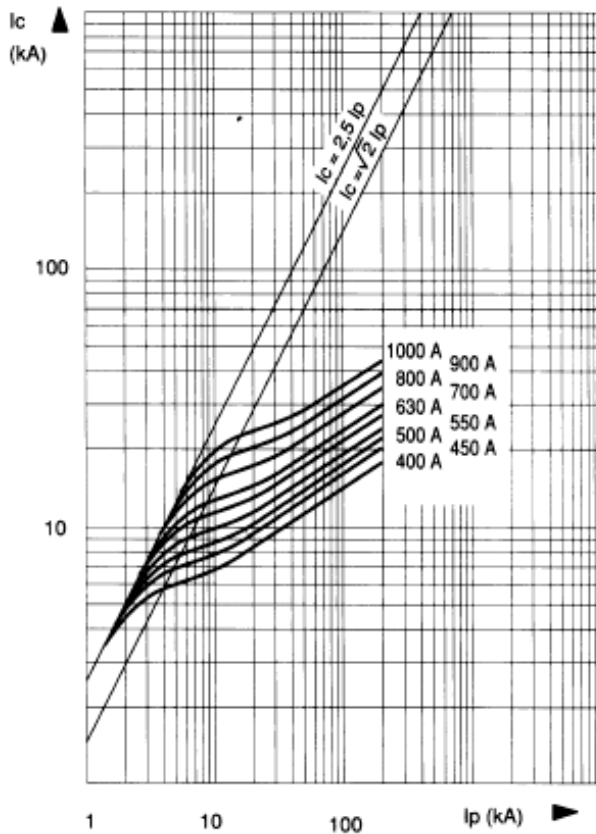

Size 3

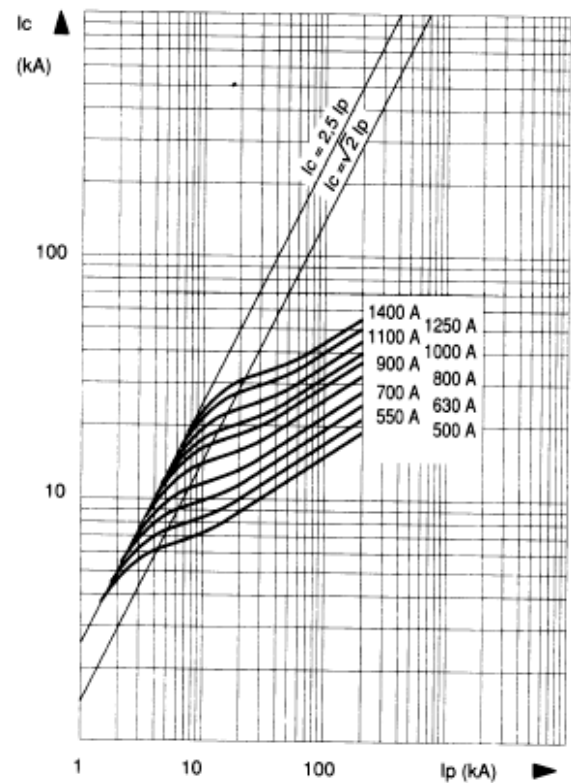

**Corrective Factor – Peak Arc Voltage:**

**I<sup>2</sup>t Multiplier Coefficient**

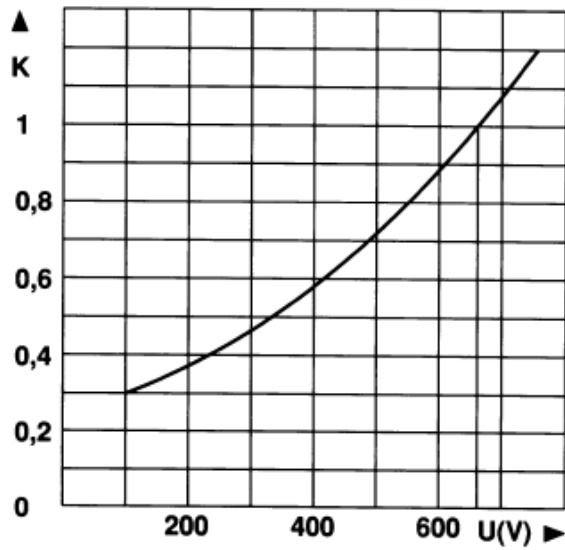

The above Mean curve shows variation of total clearing time ( $I^2t_i$ ) and total operating time  $T_t$  in accordance with working voltage U.

**Peak Arc Voltage**

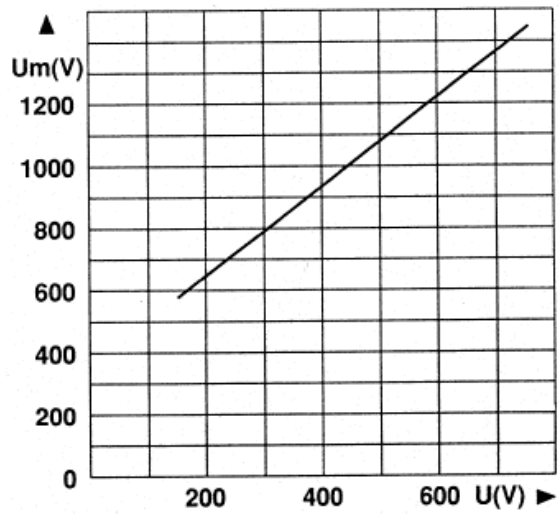

Curve indicating peak arc voltage  $U_m$  which may appear across fuse terminals as a function of working voltage U @  $\cos \varphi = 0.15$ .

**Dissipated Power**

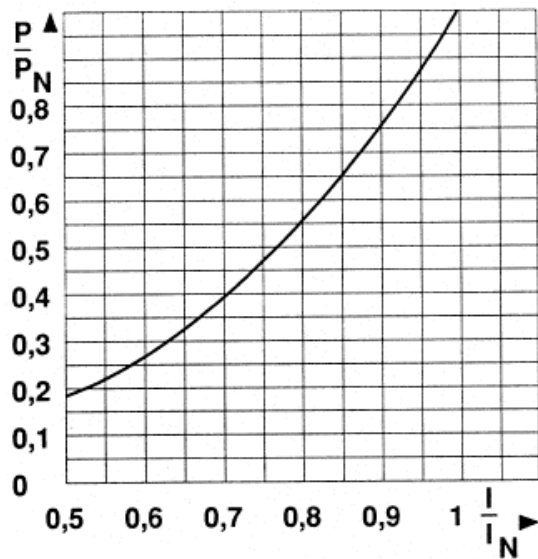

Curve enabling calculation of dissipated power P by a fuse rated  $I_N$ , as a function of the RMS current I, in multiples of  $I_N$  in a steady state.

**Outline Drawing & Ordering Information:**

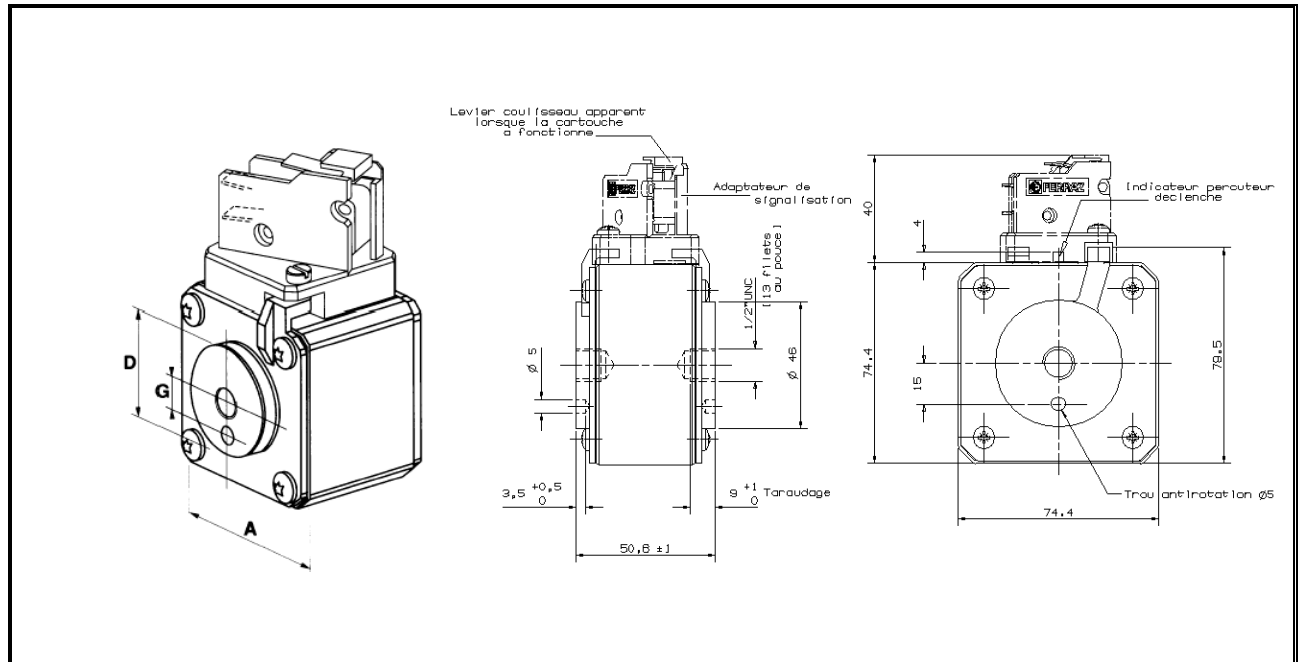

Dimensions (mm)									
Size	A	B	C	D	E	d Imperial	G	p	Weight
0	40	46.5	82	26	50.6	5/16-18"	9	6	245g
1	51	56.5	91	30	50.6	5/16-18"	9	9	370g
2	60	65.5	100	38 / 42*	50.6	3/8-16"	15	9	510g / 600g
3	74.5	79.5	114	46 / 52*	50.6	1/2-13"	15	9	790g / 910g

\*size 2 from 900A and size 3 from 1250A

ORDERING INFORMATION (Please quote code as below)					
Voltage Rating (V)	Type	Size	Fixing	Current Rating Amps	Indicator Type
700	US	0, 1, 2, or 3	U	0063 – 1600	B

Order code: eg. **070US3U0063B** = 700V, American Square Body Fuse with end contacts, Size 3, imperial thread, 63A with button indicator

**IXYS Semiconductor GmbH**  
 Edisonstraße 15  
 D-68623 Lampertheim  
 Tel: +49 6206 503-0  
 Fax: +49 6206 503-627  
 E-mail: [marcom@ixys.de](mailto:marcom@ixys.de)



**Westcode Semiconductors Ltd**  
 Langley Park Way Langley Park  
 Chippenham Wiltshire SN15 1GE  
 Tel: +44 (0)1249 444524  
 Fax: +44 (0)1249 659448  
 E-mail: [WSL.sales@westcode.com](mailto:WSL.sales@westcode.com)

**IXYS Corporation**  
 3540 Bassett Street  
 Santa Clara CA 95054 USA  
 Tel: +1 (408) 982 0700  
 Fax: +1 (408) 496 0670  
 E-mail: [sales@ixys.com](mailto:sales@ixys.com)

[www.westcode.com](http://www.westcode.com)

[www.ixys.com](http://www.ixys.com)

**Westcode Semiconductors Inc**  
 3270 Cherry Avenue  
 Long Beach CA 90807 USA  
 Tel: +1 (562) 595 6971  
 Fax: +1 (562) 595 8182  
 E-mail: [WSI.sales@westcode.com](mailto:WSI.sales@westcode.com)

The information contained herein is confidential and is protected by Copyright. The information may not be used or disclosed except with the written permission of and in the manner permitted by the proprietors Westcode Semiconductors Ltd.

© Westcode Semiconductors Ltd.

In the interest of product improvement, Westcode reserves the right to change specifications at any time without prior notice.