

# Universal Streak Camera C5680 Series

Measurements Ranging From X-Ray to Near Infrared With a Temporal Resolution of 2 ps

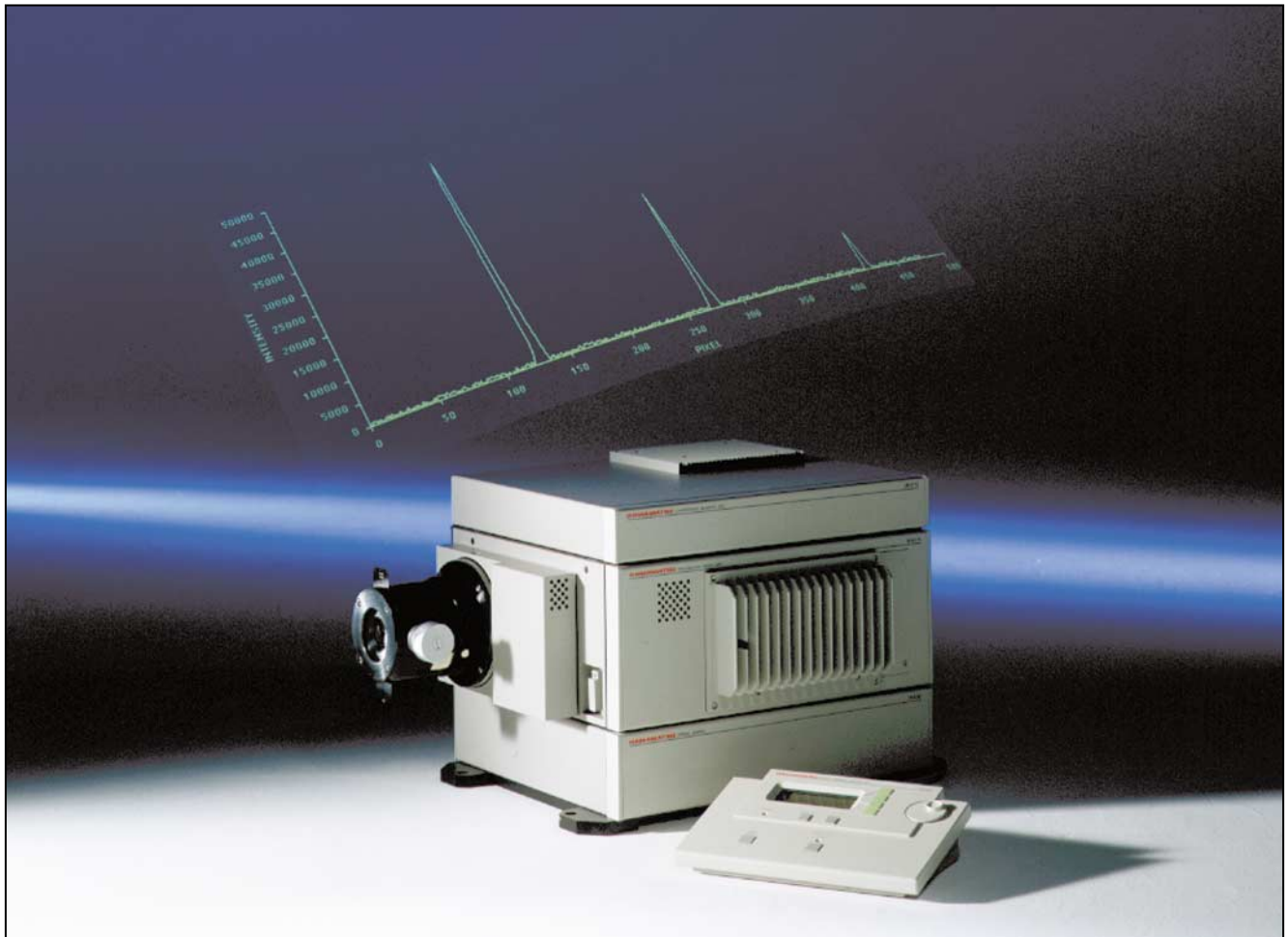

The streak camera is an ultra high-speed detector which captures light emission phenomena occurring in extremely short time periods. Not only can the streak camera measure intensity variations with superb temporal resolution, but it can also be used for simultaneous measurement of the spatial (or spectral) distribution.

The C5680 Streak Camera Series is a universal streak camera which incorporates all of the specialized technology and expertise HAMAMATSU has acquired in over 20 years of research. The streak tubes are manufactured on a regular production schedule at Hamamatsu to provide consistency and reliability. Special requests and custom designs are also available.

## APPLICATIONS

- Measurement of electron bunch for synchrotron and LINAC applications
- Research involving X-ray lasers, free electron lasers, and various other types of pulsed lasers
- Plasma light emission, radiation, laser ablation, combustion and explosions
- Fluorescence lifetime measurement, transient absorption measurement, time-resolved raman spectroscopy
- Optical soliton communications, response measurement with quantum devices
- Lidar Thomson scattering, laser distance measurement

# HAMAMATSU

## FEATURES

- **Temporal resolution of within 2 ps**

A temporal resolution of 2 ps is achieved for both synchroscan and single shot.



- **Several plug-in module, operating mode.**
- **Accommodates a diverse range of experimental setups from single light emitting phenomena to high-speed repeated phenomena in the GHz.**
- **Can be used in X-ray to near infrared fields**  
By selecting the appropriate streak tube (light sensor), the C5680 can be used in a wide range of measurement applications, from X-rays to near infrared light.
- **Simultaneous measurement of light intensity on temporal and spatial (wavelength) axes**  
Spectrograph can be placed in front of the streak camera, to convert the spatial axis to a wavelength axis. This enables changes in the light intensity to be measured over various wavelength (time-resolved spectroscopy).
- **Ultra-high sensitivity (detection of single photons)**  
The streak tube converts light into electrons which are then multiplied by an electron multiplier. This enables detection of extremely faint light (at the single-photon level). (See photon counting integration principle)
- **IEEE-488 (GP-IB) control**  
Computer control enables remote control and advanced measurements to be performed out using very simple operation.
- **Diverse selection of peripheral equipment**  
A full lineup of peripheral devices is available, including spectroscopes, optical trigger heads, and expansion units.

### The operating principle of the streak camera

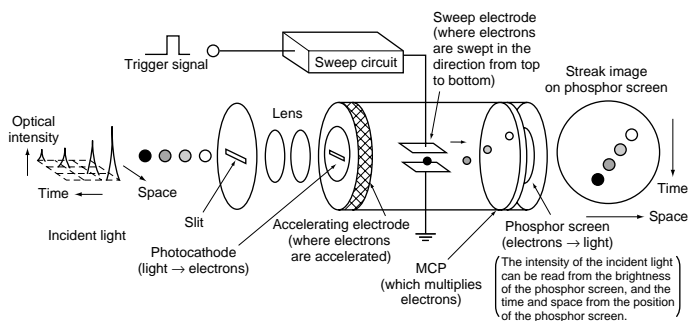

## OPERATING PRINCIPLE

The light pulse to be measured is projected onto the slit and is focused by the lens into an optical image on the photocathode of the streak tube. Changing the temporal and spatial offset slightly each time, four light pulses, each with a different light intensity, are introduced through the slit and conducted to the photocathode.

Here, the photons are converted into a number of electrons proportional to the intensity of the incident light. The four light pulses are converted sequentially to electrons which are then accelerated and conducted towards the photocathode.

As the group of electrons created from the four light pulses passes between a pair of sweep electrodes, a high voltage is applied (see above), resulting in a high-speed sweep (the electrons are swept in the direction from top to bottom). The electrons are deflected at different times, and at slightly different angles in the perpendicular direction, and are then conducted to the MCP (micro-channel plate).

As the electrons pass the MCP, they are multiplied several thousands of times and are then bombarded against the phosphor screen, where they are converted back into light.

The fluorescence image corresponding to the first incident light pulse is positioned at the top of the phosphor screen, followed by the others, with images proceeding in descending order; in other words, the axis in the perpendicular direction on the phosphor screen serves as the temporal axis. The brightnesses of the various fluorescence images are proportional to the intensities of the corresponding incident light pulses. The positions in the horizontal direction on the phosphor screen correspond to the positions of the incident light in the horizontal direction.

## THE PRINCIPLE OF PHOTON COUNTING INTEGRATION

Photoelectrons given off from the photocathode of the streak tube are multiplied at a high integration rate by the MCP, and one photoelectron is counted as one intensity point on the phosphor screen. A threshold value is then used with this photoelectron image to clearly separate out noise.

Separation of Photoelectron Image and Noise

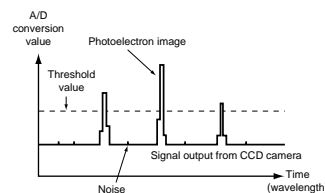

Photon Counting Integration

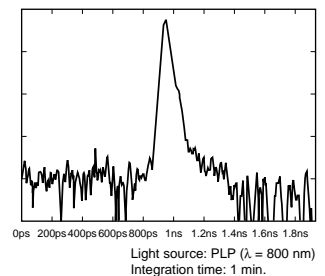

Positions in the photoelectron image which are above the threshold value are detected and are integrated in the memory, enabling noise to be eliminated completely. This makes it possible to achieve data measurements with a high dynamic range and high S/N.

# FUNCTION CONFIGURATION

## 1 C5680 Main Unit (with power supply and camera controller)

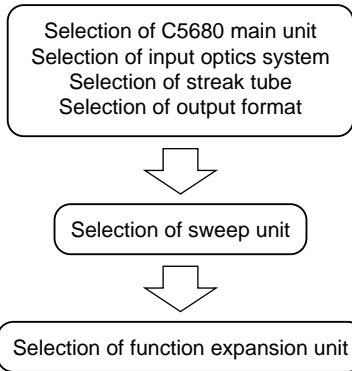
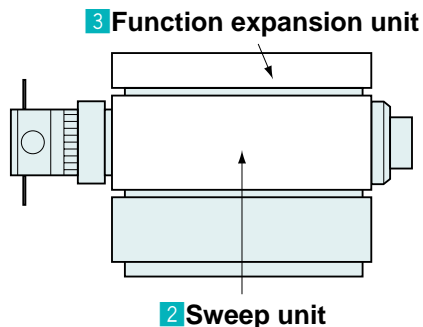

# SPECIFICATIONS

## 1 C5680 Main Unit

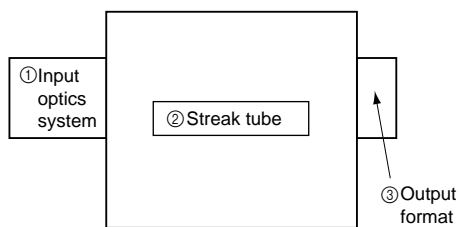

### [Suffix (Model No.)]

One of the following suffixes is appended to the model number of the C5680, depending on the type of streak tube and output format used.

- C5680**—□ □ ..... 1 Accommodates 200 nm to 850 nm, 1 MCP  
 : 2 Accommodates 300 nm to 1600 nm, 1 MCP  
 : 3 Accommodates 115 nm to 850 nm, 1 MCP  
 2 Lens output type 4 Accommodates 200 nm to 900 nm, 1 MCP  
 3 Video output type 5 Accommodates 200 nm to 850 nm, 2 MCPs

### ① Input Optics System

Model Name	Spectral Transmission	Effective F Value	Image Multiplication Ratio	Slit Width	Slit Width Reading Precision	Overall Length
A1976-01	200 nm to 1600 nm	5.0	1 : 1	0 to 5 mm	5 μm	98.2 mm
A1974	400 nm to 900 nm	1.2	1 : 1			159 mm
A1974-01	400 nm to 1600 nm	1.2	1 : 1			159 mm
A1976-04	200 nm to 1600 nm	3.5	1 : 1			98.2 mm

The A1974 and A1974-01 are optional units.

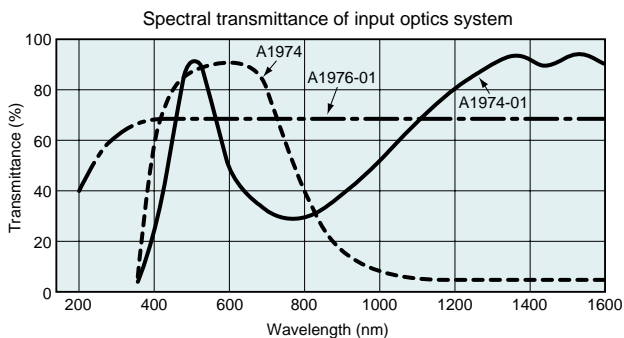

### ② Streak Tube

Model Name	Spectral Response Characteristic	Effective Photocathode Size	MCP Gain	Phosphor Screen	Spatial Resolution
N5716	200 nm to 850 nm	• 0.15 × 5.3 mm Lens output type • 0.15 × 4.8 mm Video output type	3 × 10 <sup>3</sup>	• Photocathode characteristic P-43 • Fiber-optic output • Effective photocathode size	25 lp/mm or more centered on photocathode
N5716-02	300 nm to 1600 nm				
N5716-01	115 nm to 850 nm				
N5716-03	200 nm to 900 nm				
N5864	200 nm to 850 nm		6 × 10 <sup>5</sup>	• 18 mm	

X-ray streak cameras designed for use with 10 eV to 10 keV can also be selected.

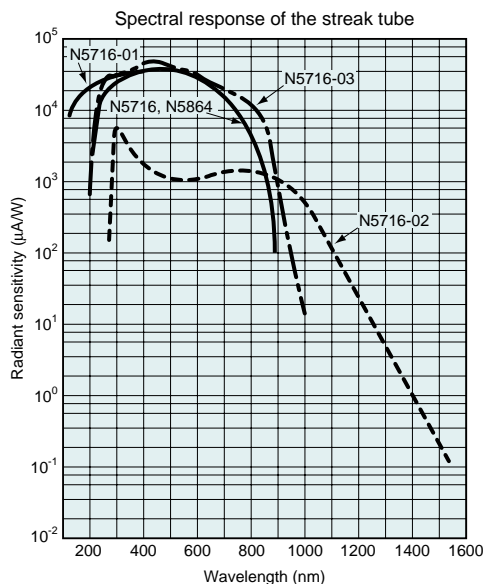

### ③ Output Formats

- **Lens output** ..... Magnification 1 : 0.7 (50 mm : 35 mm)  
Effective F value F/2.0  
F-mount
- **Video output** ... Signal format CCIR or RS-170  
Coupling method Fiber optics  
Resolution 768 × 493 or 756 × 581 pixels

### ④ Other 5680 Specifications

- Gate

Gating Method	Gate Extinction Ratio	Gate Time
MCP + horizontal blanking	1 : 10 <sup>6</sup> min.	50 ns to continuous
MCP + horizontal blanking + photocathode	1 : 10 <sup>8</sup> min.	50 ns to continuous

- Gate trigger input ..... 3.5 V to 5.0 V/50 Ω
- Gate trigger delay time ..... 120 ns max.
- Max. horizontal blanking repetition frequency ..... 2 MHz
- Max. MCP gate repetition frequency ..... 10 kHz
- Max. photocathode gate repetition frequency ..... 10 kHz
- Monitor out signal ..... 3.5 Vp-p (typ.)
- Interface ..... IEEE-488 (GP-IB)
- Status output ..... D sub-connector DB-25S, 16-bit parallel output, open collector
- Line voltage ..... AC110/117/220/240 V, 50/60 Hz
- Power consumption ..... Approx. 180 V·A

## 2 Sweep units (Plug-in: built into main unit)

- **M5675 Synchroscan Unit**

- Temporal resolution ..... Better than 2 ps at 800 nm (N5716-01)  
Better than 3 ps at 800 nm (N5716-02)
- Sweep range Video output type . 150 ps to 1/6 fs (fs:synchroscan frequency)  
Lens output type ... 200 ps to 1/6 fs
- Sweep range ..... 4 selectable range
- Synchroscan frequency ..... Factory set within a range of 75 MHz to 165 MHz
- Synchronous frequency range .. fs ± 0.2 MHz (fs = synchroscan frequency)
- Trigger jitter ..... Better than temporal resolution
- Trigger signal input ..... -3 dBm to 17 dBm / 50 Ω



- **M5676 Fast Single Sweep Unit**

- Temporal resolution ..... Better than 2 ps at 800 nm (1.5 ps typ.)
- Sweep time Video output type ..... 0.15, 0.5, 1, 2, 5, 10, 20, 50 ns/full screen  
Lens output type ..... 0.2, 0.5, 1, 2, 5, 10, 20, 50 ns/full screen
- Trigger jitter ..... Better than 20 ps
- Trigger delay ..... Approx. 13 ns (fastest range)
- Maximum sweep repetition frequency (max.) ... 10 kHz
- Trigger signal input ..... ± 5 V/50 Ω

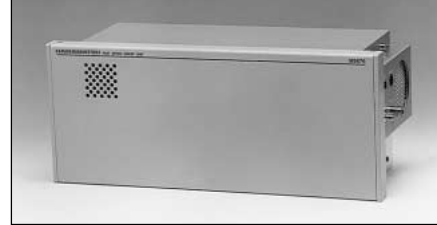

- **M5677 Slow Single Sweep Unit**

- Temporal resolution ..... Better than 50 ps
- Sweep time ..... 50 ns to 1 ms/full screen
- Trigger jitter ..... Better than temporal resolution
- Trigger delay ..... Approx. 45 ns (fastest range)
- Maximum sweep repetition frequency (max.) .. 2 MHz (fastest range)
- Trigger signal input ..... ± 5 V/50 Ω



## 3 Function Expansion Units (connected to top of main unit)

- **M5678 Synchronous Blanking Unit**  
(designed for use in conjunction with M5675 Synchroscan)

- Synchroscan frequency ..... Factory set within a range of 75 MHz to 165 MHz
- Horizontal shift width ..... 2.5 mm or 11 mm (at phosphor screen)



- **M5679 Dual Time Base Extender Unit**  
(Can be used in conjunction with all sweep units)

- Sweep time ..... 10 ns to 100 ms/full screen
- Maximum sweep repetition frequency (max.) ... 10 Hz
- Trigger signal input ..... ± 5 V/50 Ω



# READOUT SYSTEM (HPD-TA)

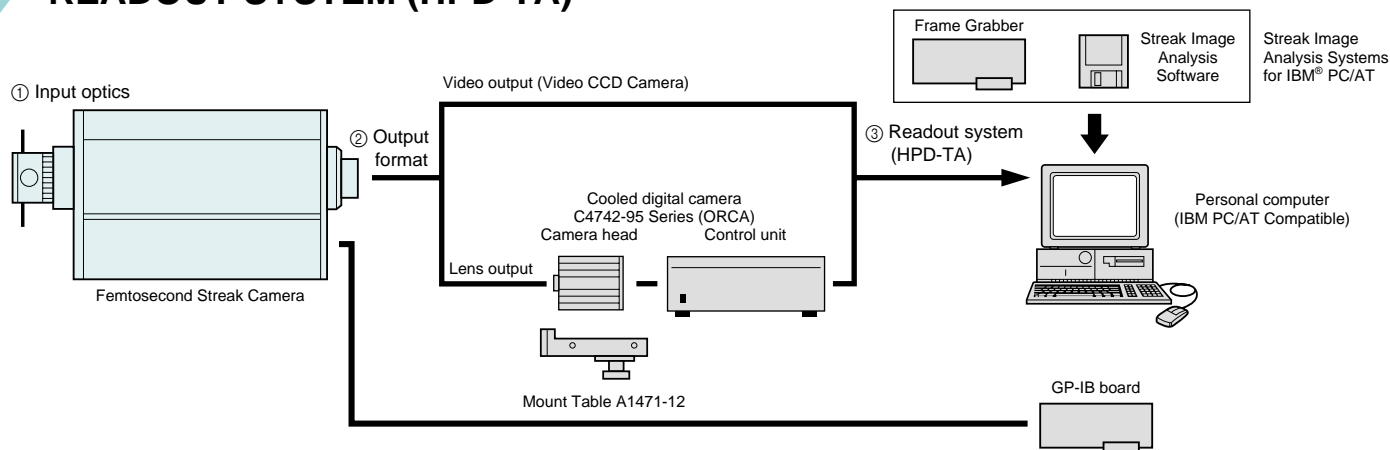

## 4 General Outline

The HPD-TA (Temporal Analyzer) is a high-performance digital data acquisition and control system specifically designed to read out images from the Hamamatsu streak camera's phosphor screen. It enables precise, quantitative acquisition and pre-analysis of two dimensional streak data that includes photon counting plus a full range of data correction and calibration possibilities. It possible to select the best camera for a given streak configuration and application. The camera is connected to an IBM-compatible PC/AT via a frame grabber board that can support real-time data transfer.

The HPD-TA allows the remote control of the C5680 via GPIB interface. The entire system is controlled through a powerful but userfriendly software application that runs on a Microsoft Windows platform.

\* A read out system based on the Macintosh<sup>®</sup> computer is also available.

Please consult with our sales office for more details.

### •Functions & Specifications

Items	Cooled CCD version	Video version
Camera model	C4742-95 Series (ORCA)	Video CCD
Coupling method	Relay lens	Fiber optics
Resolution (pixels)	1280 × 1024	756 × 581
Dynamic range	Single frame	8 bits
	Integration	16 bits
Frame rate	9 Hz (normal) / 18 Hz (super pixel)	30 Hz
Superpixel mode	•	–
Subarray scan mode	•	–
Single exposure time	132 μs to 10 s	40 ms or 33 ms
Analog integration	on chip / into memory	into memory
Photon counting	•	•
Dark correction	•	•
Shading correction	•	•
Curvature correction	•	•
Calibration	linear / nonlinear, both ax	linear / nonlinear, both axes
Multiple profiles	up to 10	up to 10
Data export (images)	Binary, TIFF, ASCII	Binary, TIFF, ASCII
Data export (profiles)	ASCII	ASCII
Streak camera interface	GPIB or StatusPort	GPIB or StatusPort
Other devices interf	GPIB	GPIB

## 5 Computer Environment

The HPD-TA requires an industry-standard Pentium-class (or compatible) PC with a 32-bit Microsoft Windows version. A fast, high-resolution graphics configuration is recommended. Depending on the streak camera system configuration, a number of PCI and/or

ISA slots as well as a serial interface port may be occupied. (Please consult Hamamatsu for a detailed specification for a given case.)



## PERIPHERAL EQUIPMENT

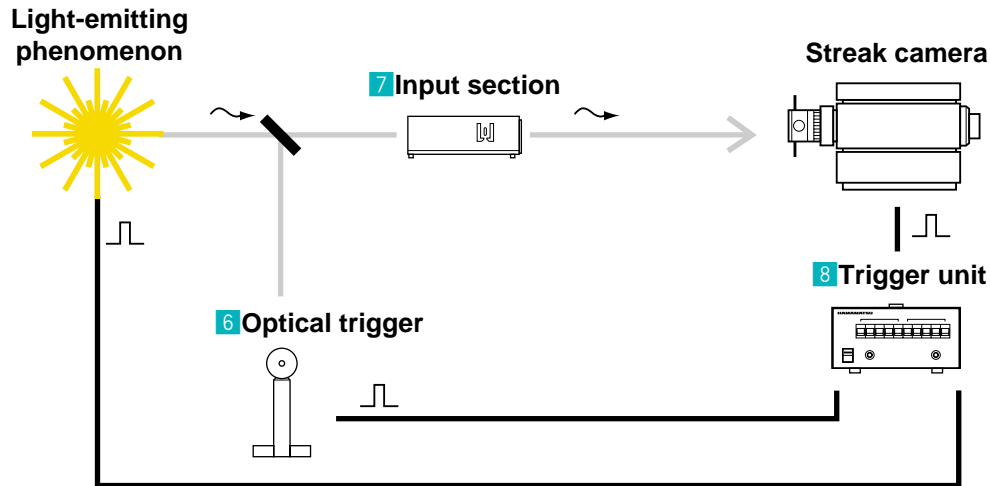

### 6 Optical Trigger (PIN diode head)

- **PIN Diode Head C1083-01 (for Low Repetition)**



Spectral response	400 nm to 1100 nm
Rise time	0.8 ns
Dimensions/weight	Head: 100 (W) × 160 to 235 (H) × 50 (D) mm/400 g Power supply unit: 100 (W) × 83(H) × 100 (D) mm/400 g
Power supply	+22.5 V (battery)

- **PIN Diode Head C1808-03 (for High Repetition)**



Minimum input level	1 mW (f=80 MHz, $\lambda=800$ nm, FWHM<1 ps)
Saturation output level	Approx. 1.5 Vp-p (50 $\Omega$ )
Frequency band	<100 MHz
Power supply	INPUT Voltage range 100 V to 240 V Input power supply frequency range 50/60 Hz

### 7 Input Section

- **Spectroscopes C5094 and C5095**



	C5094	C5095
Optical layout	Czerny-Turner model (with toroidal mirror for aberration correction)	
Focal distance	250 mm	500 mm
F value	4	8
Incident light slit width	Variable between 10 $\mu$ m to 2,000 $\mu$ m	
Grating	Up to 3 can be installed simultaneously	
Reciprocal dispersion	2.5 nm/mm (when using 1200 gr/mm)	1.5 nm/mm (when using 1200 gr/mm)
Wavelength resolution	< reciprocal dispersion × 0.06	

The following are needed in order to connect these units to the C5680:

- A spectroscope mounting table
- A spectroscope adaptor
- A light source for wavelength axis calibration (mercury lamp, etc.)

- **Fiber-optic Input Optics System (FC Connector) A6368**

This fiber-optic input optics system can be connected in place of the incident light slit in the C5680.

- **Objective Lens**

Connecting a C-mount adaptor to the incident light slit section of the C5680 enables attachment of a C-mount objective lens. F-mount objective lenses can also be attached using an FC converter.

## 8 Trigger Units

- **Delay Unit C1097-01**



This unit can be used to align the operation timing of the streak camera with the target phenomenon.

\*The C1097-04, which has a GP-IB interface, is also available.

Variable delay range	0 to 31.96 ns
Delay setting range	30, 60, 120, 250, 500 ps, 1, 2, 4, 8, 16 ns
Minimum delay time	Approx. 12 ns
Maximum input voltage	30 V
Power supply	AC85 V to 250 V
External dimensions/weight	215 (W) × 350 (D) × 102 (H) mm/3.4 kg

- **High-stability Delay Unit C6878**



Used in combination with a synchroscan unit, this unit is used to adjust the delay times of trigger signals. In addition, the amount by which trigger signals are delayed is adjusted automatically, while monitoring the sweep signal, enabling stable acquisition of streak images over a long period of time.

- **RF Up Converter Unit C6207**



This outputs an output signal of 100 MHz synchronized to the 10 MHz input signal.

Inputting reference output signals from a commercial frequency synthesizer enables stable synchroscan triggers to be obtained.

Input signal frequency	10 MHz ± 10 Hz
Input level	-10 dBm to 0 dBm/50 Ω
Output frequency	100 MHz
Output signal level	3 dBm/50 Ω (typ.)
Timing jitter	σ: 1 ps max.
Power supply	AC100/117/220/240V, 50/60 Hz

- **Other**

Numerous other peripheral devices are also available, such as the DG535 Digital Delay Generator and the Picosecond Light Pulser PLP Series. Please feel free to contact HAMAMATSU concerning these and other devices.

## DIMENSIONAL OUTLINES (Unit: mm)

• **C5680 main unit (approx. 20 kg)**

C5680-0X (lens output)

C5680-1X (video output)

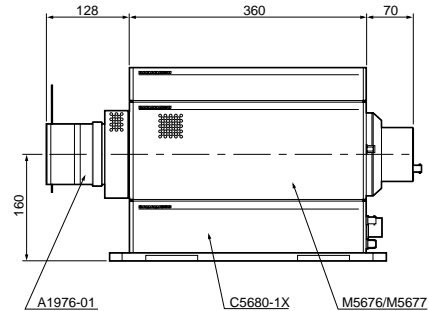
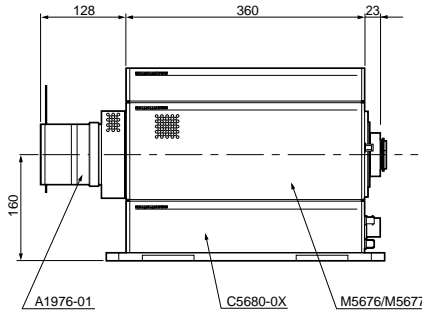
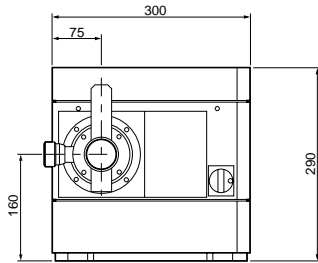

• **Power supply unit (approx. 10 kg)**

• **Remote control unit (approx. 1.2 kg)**

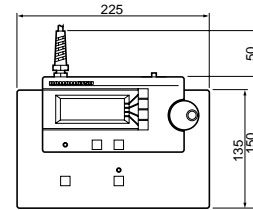
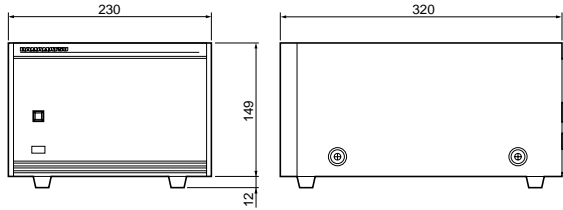

• **Synchroscan Unit M5675 (approx. 4.1 kg)**

• **Fast Single Sweep Unit M5676 (approx. 2.4 kg)**

• **Slow Single Sweep Unit M5677 (approx. 2.2 kg)**

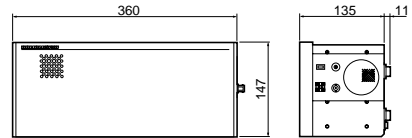
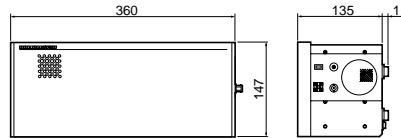
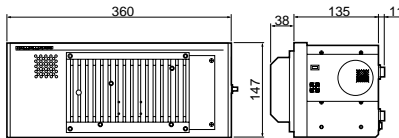

• **Synchronous Blanking Unit M5678 (approx. 3.4 kg)**

• **Dual Time Base Extender Unit M5679 (approx. 3.4 kg)**

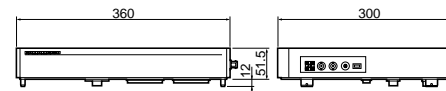
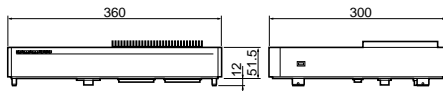

- ★ IBM is a registered trade mark of IBM Co.
  - ★ Macintosh is registered trademark of Apple Computer, Inc.
  - ★ Product and software package names noted in this documentation are trademarks or registered trademarks of their respective manufacturers.
  - Subject to local technical requirements and regulations, availability of products included in this promotional material may vary. Please consult with our sales office.
  - Information furnished by HAMAMATSU is believed to be reliable. However, no responsibility is assumed for possible inaccuracies or omissions. Specifications and external appearance are subject to change without notice.
- © 2003 Hamamatsu Photonics K.K.



# HAMAMATSU

Homepage Address <http://www.hamamatsu.com>

HAMAMATSU PHOTONICS K.K., Systems Division  
812 Joko-cho, Hamamatsu City, 431-3196, Japan, Telephone: (81)53-431-0124, Fax: (81)53-435-1574, E-mail: [export@sys.hpk.co.jp](mailto:export@sys.hpk.co.jp)

U.S.A. and Canada: Hamamatsu Photonic Systems: 360 Foothill Road, Bridgewater, N.J. 08807-0910, U.S.A., Telephone: (1)908-231-1116, Fax: (1)908-231-0852, E-mail: [usa@hamamatsu.com](mailto:usa@hamamatsu.com)

Germany: Hamamatsu Photonics Deutschland GmbH: Arzbergerstr. 10, D-82211 Herrsching am Ammersee, Germany, Telephone: (49)8152-375-0, Fax: (49)8152-2658, E-mail: [info@hamamatsu.de](mailto:info@hamamatsu.de)

France: Hamamatsu Photonics France S.A.R.L.: 8, Rue du Saule Trapu, Parc du Moulin de Massy, 91882 Massy Cedex, France, Telephone: (33)1 69 53 71 00, Fax: (33)1 69 53 71 10, E-mail: [infos@hamamatsu.fr](mailto:infos@hamamatsu.fr)

United Kingdom: Hamamatsu Photonics UK Limited: 2 Howard Court, 10 Tewin Road Welwyn Garden City Hertfordshire AL7 1BW U.K., Telephone: (44)1707-294888, Fax: (44)1707-325777, E-mail: [info@hamamatsu.co.uk](mailto:info@hamamatsu.co.uk)

North Europe: Hamamatsu Photonics Norden AB: Smidesvägen 12, SE-171-41 Solna, Sweden, Telephone: (46)8-509-031-00, Fax: (46)8-509-031-01, E-mail: [info@hamamatsu.se](mailto:info@hamamatsu.se)

Italy: Hamamatsu Photonics Italia S.R.L.: Strada della Moia, 1/E 20020 Arese (Milano), Italy, Telephone: (39)02-935 81 733, Fax: (39)02-935 81 741, E-mail: [info@hamamatsu.it](mailto:info@hamamatsu.it)

Cat. No. SSCS 1046E07  
AUG/2003 HPK  
Created in Japan (PDF)