

DATA SHEET

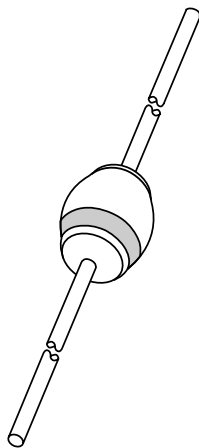

1N5059 to 1N5062 **Controlled avalanche rectifiers**

Product specification
Supersedes data of April 1992
File under Discrete Semiconductors, SC01

1996 Jun 19

Controlled avalanche rectifiers

1N5059 to 1N5062

FEATURES

- Glass passivated
- High maximum operating temperature
- Low leakage current
- Excellent stability
- Guaranteed avalanche energy absorption capability
- Available in ammo-pack.

DESCRIPTION

Rugged glass package, using a high temperature alloyed construction.

This package is hermetically sealed and fatigue free as coefficients of expansion of all used parts are matched.

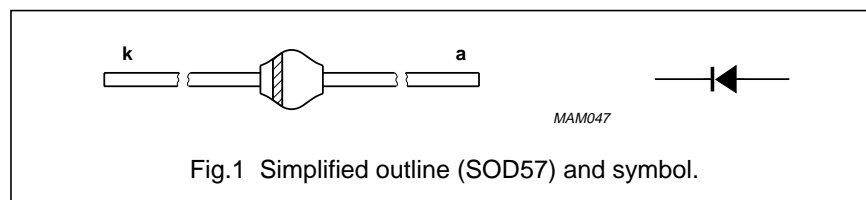

LIMITING VALUES

In accordance with the Absolute Maximum Rating System (IEC 134).

SYMBOL	PARAMETER	CONDITIONS	MIN.	MAX.	UNIT
V_{RRM}	repetitive peak reverse voltage				
	1N5059		–	200	V
	1N5060		–	400	V
	1N5061		–	600	V
V_{RWM}	crest working reverse voltage				
	1N5059		–	200	V
	1N5060		–	400	V
	1N5061		–	600	V
V_R	continuous reverse voltage				
	1N5059		–	200	V
	1N5060		–	400	V
	1N5061		–	600	V
$I_{F(AV)}$	average forward current	$T_{tp} = 45\text{ °C}$; lead length = 10 mm; averaged over any 20 ms period; see Figs 2 and 4	–	2.0	A
		$T_{amb} = 80\text{ °C}$; PCB mounting (see Fig.9); averaged over any 20 ms period; see Figs 3 and 4	–	0.8	A
I_{FSM}	non-repetitive peak forward current	$t = 10\text{ ms}$ half sinewave	–	50	A
E_{RSM}	non-repetitive peak reverse avalanche energy	$L = 120\text{ mH}$; $T_j = T_{j\text{ max}}$ prior to surge; inductive load switched off	–	20	mJ
T_{stg}	storage temperature		–65	+175	°C
T_j	junction temperature	see Fig.5	–65	+175	°C

Controlled avalanche rectifiers

1N5059 to 1N5062

ELECTRICAL CHARACTERISTICS

$T_j = 25\text{ }^\circ\text{C}$; unless otherwise specified.

SYMBOL	PARAMETER	CONDITIONS	MIN.	TYP.	MAX.	UNIT	
V_F	forward voltage	$I_F = 1\text{ A}$; $T_j = T_{j\text{ max}}$; see Fig.6	–	–	0.8	V	
		$I_F = 1\text{ A}$; see Fig.6	–	–	1.0	V	
$V_{(BR)R}$	reverse avalanche breakdown voltage	$I_R = 0.1\text{ mA}$					
			1N5059	225	–	–	V
			1N5060	450	–	–	V
			1N5061	650	–	–	V
	1N5062	900	–	–	V		
I_R	reverse current	$V_R = V_{RRM\text{ max}}$; see Fig.7	–	–	1	μA	
		$V_R = V_{RRM\text{ max}}$; $T_j = 165\text{ }^\circ\text{C}$; see Fig.7	–	–	150	μA	
t_{rr}	reverse recovery time	when switched from $I_F = 0.5\text{ A}$ to $I_R = 1\text{ A}$; measured at $I_R = 0.25\text{ A}$; see Fig.10	–	3	–	μs	
C_d	diode capacitance	$V_R = 0\text{ V}$; $f = 1\text{ MHz}$; see Fig.8	–	50	–	pF	

THERMAL CHARACTERISTICS

SYMBOL	PARAMETER	CONDITIONS	VALUE	UNIT
$R_{th\ j\text{-tp}}$	thermal resistance from junction to tie-point	lead length = 10 mm	46	K/W
$R_{th\ j\text{-a}}$	thermal resistance from junction to ambient	note 1	100	K/W

Note

1. Device mounted on epoxy-glass printed-circuit board, 1.5 mm thick; thickness of copper $\geq 40\text{ }\mu\text{m}$, see Fig.9. For more information please refer to the "General Part of Handbook SC01".

Controlled avalanche rectifiers

1N5059 to 1N5062

GRAPHICAL DATA

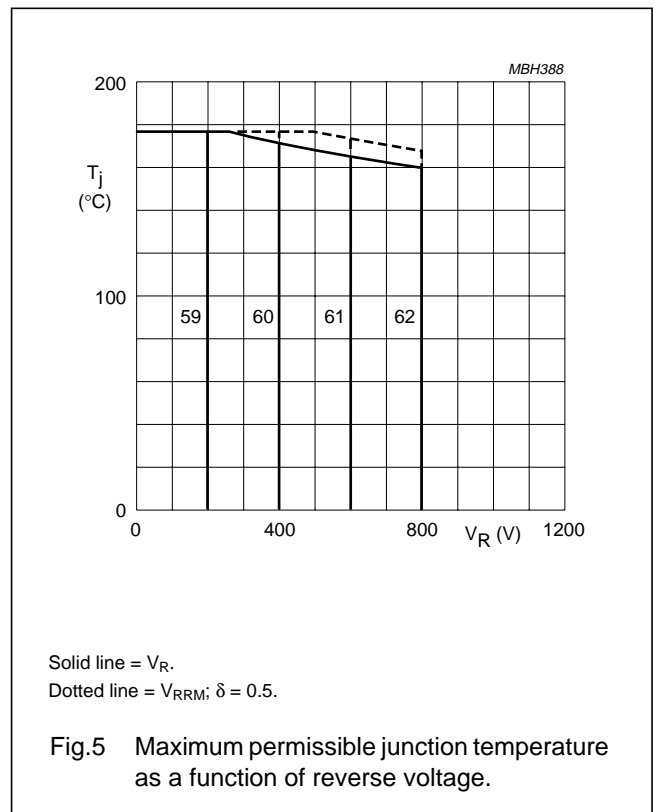
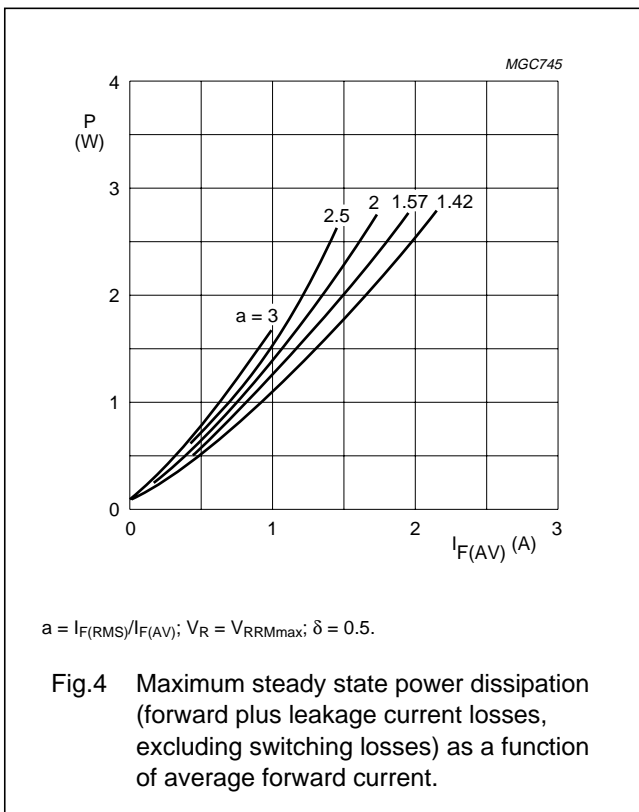
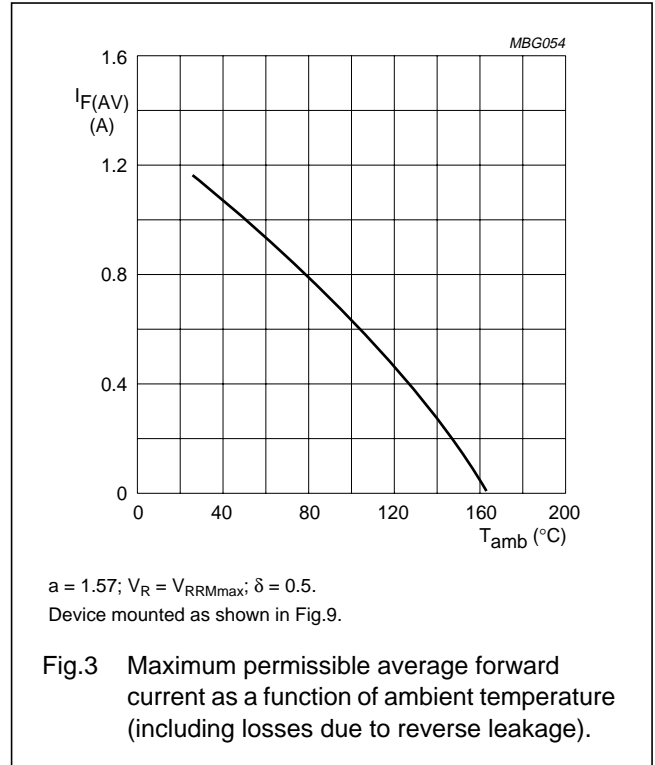
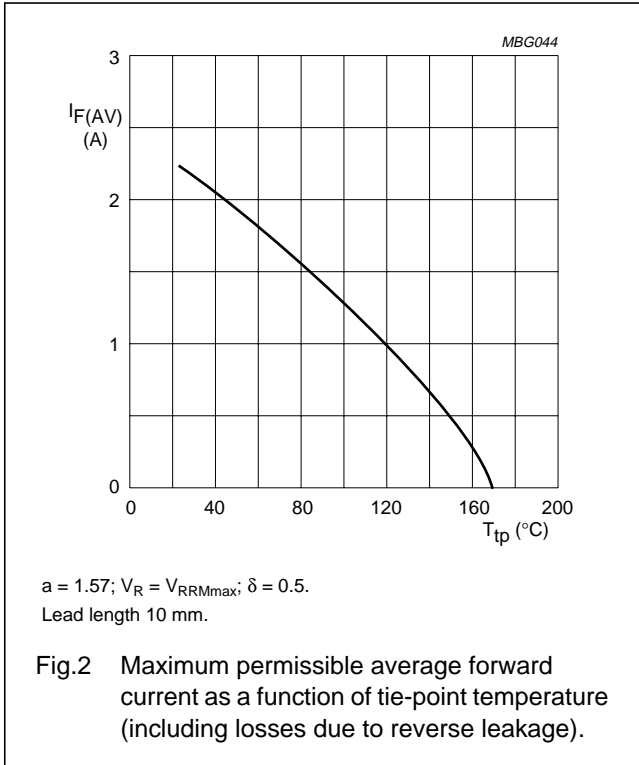

Controlled avalanche rectifiers

1N5059 to 1N5062

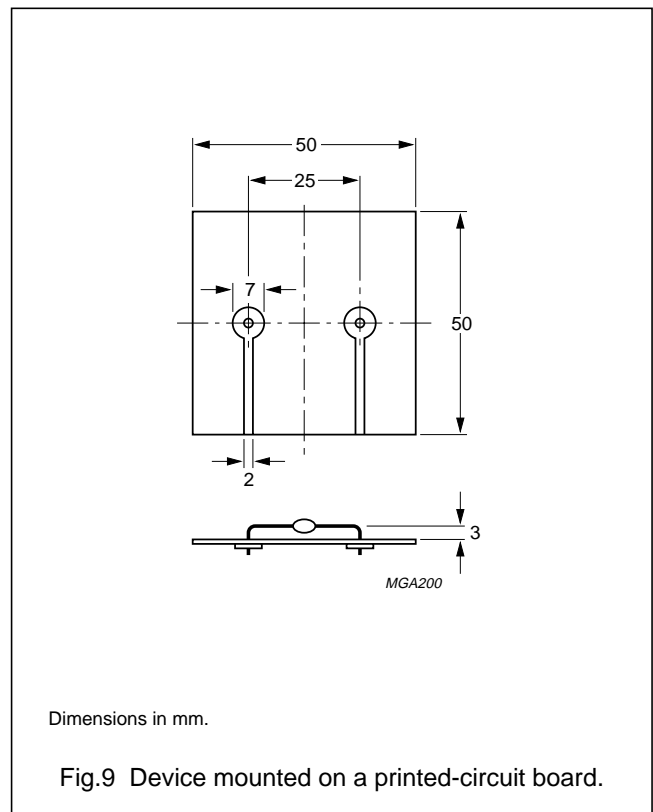
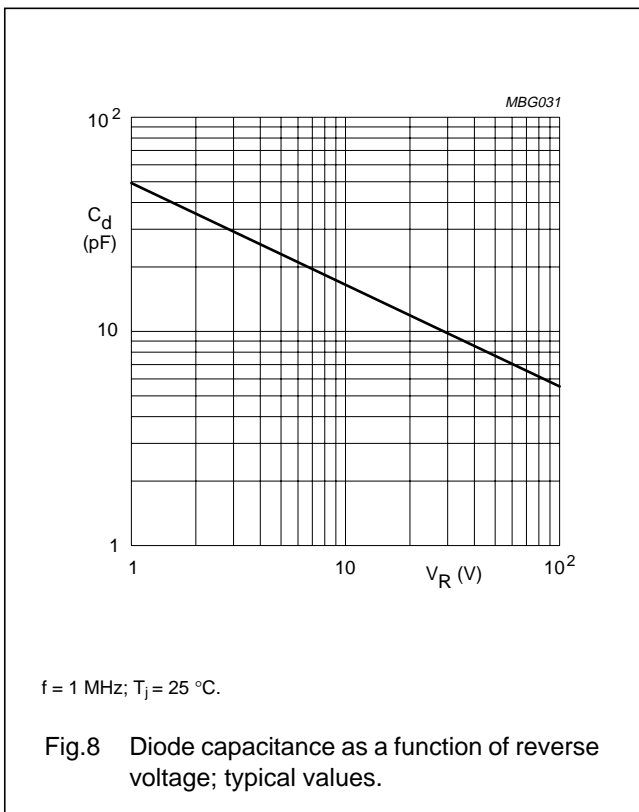
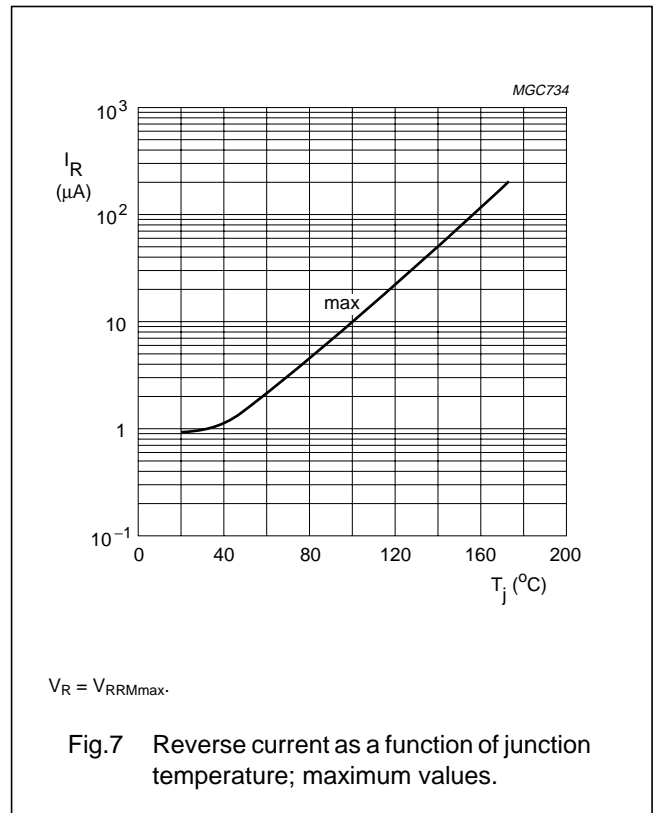
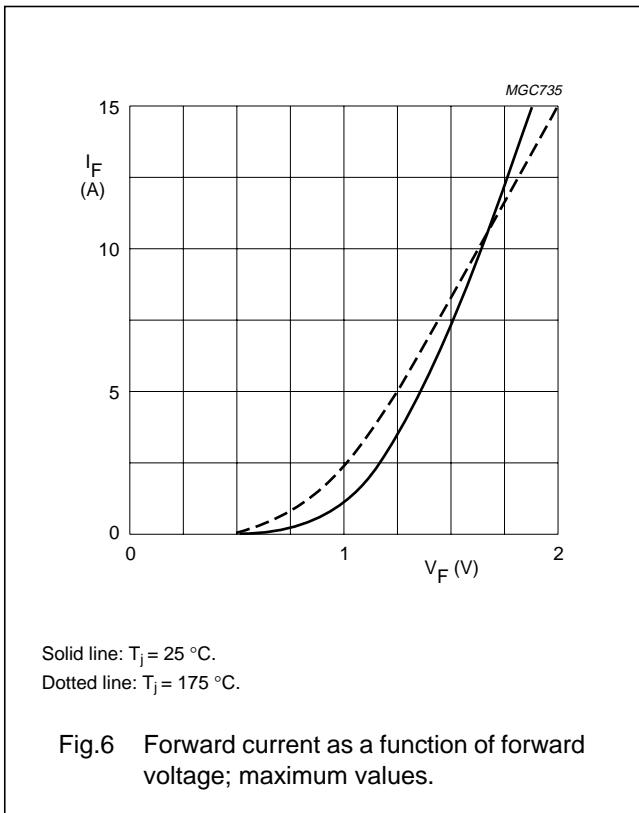

Controlled avalanche rectifiers

1N5059 to 1N5062

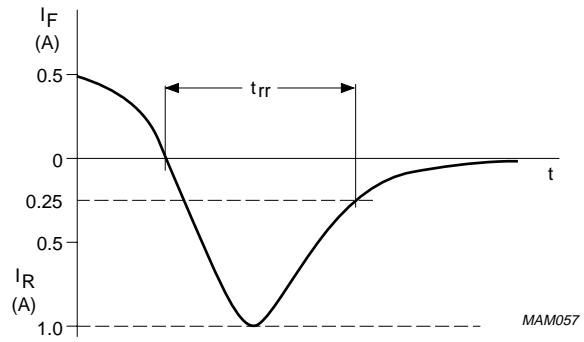
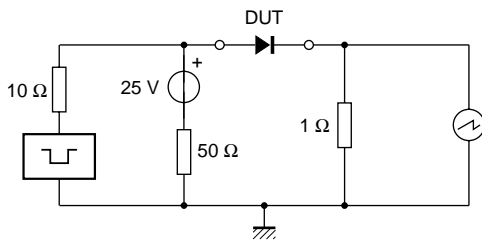

Input impedance oscilloscope: 1 MΩ, 22 pF; $t_r \leq 7$ ns.
Source impedance: 50 Ω; $t_r \leq 15$ ns.

Fig.10 Test circuit and reverse recovery time waveform and definition.

Controlled avalanche rectifiers

1N5059 to 1N5062

PACKAGE OUTLINE

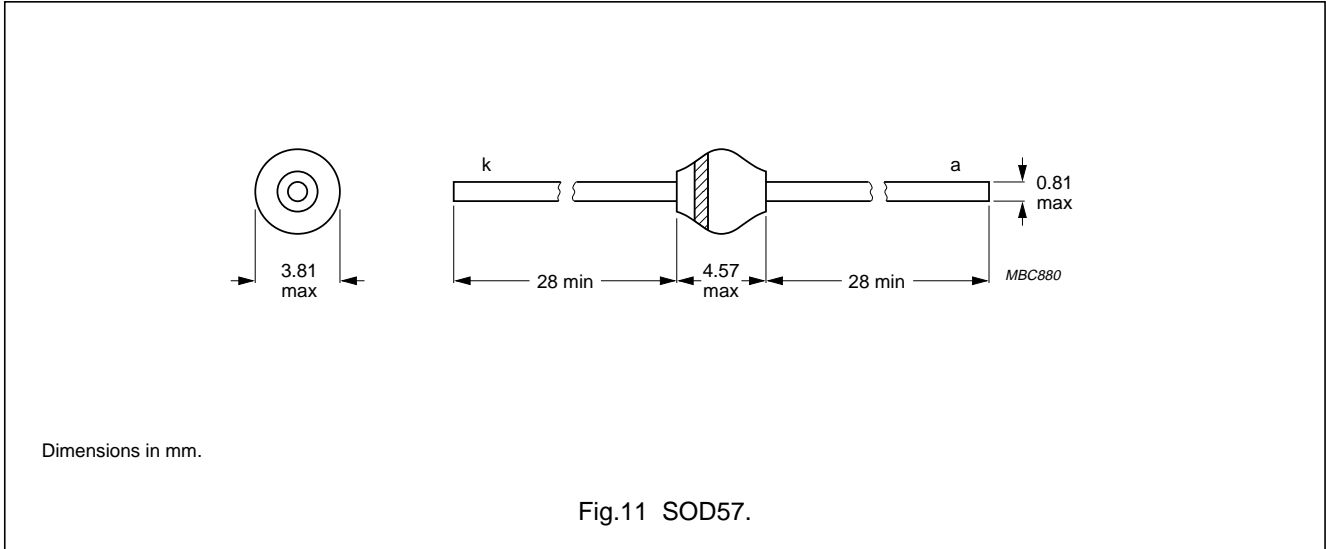

DEFINITIONS

Data sheet status	
Objective specification	This data sheet contains target or goal specifications for product development.
Preliminary specification	This data sheet contains preliminary data; supplementary data may be published later.
Product specification	This data sheet contains final product specifications.
Limiting values	
Limiting values given are in accordance with the Absolute Maximum Rating System (IEC 134). Stress above one or more of the limiting values may cause permanent damage to the device. These are stress ratings only and operation of the device at these or at any other conditions above those given in the Characteristics sections of the specification is not implied. Exposure to limiting values for extended periods may affect device reliability.	
Application information	
Where application information is given, it is advisory and does not form part of the specification.	

LIFE SUPPORT APPLICATIONS

These products are not designed for use in life support appliances, devices, or systems where malfunction of these products can reasonably be expected to result in personal injury. Philips customers using or selling these products for use in such applications do so at their own risk and agree to fully indemnify Philips for any damages resulting from such improper use or sale.