

Super Multi TOPLED® High-Current LED

LOY T672, LSG T672, LSP T672
LOP T672, LOG T672, LYP T672

Besondere Merkmale

- Gehäusebauform: P-LCC-4
- Gehäusefarbe: weiß
- als optischer Indikator einsetzbar
- besonders geeignet bei hohem Umgebungslicht durch erhöhten Betriebsstrom (≤ 50 mA DC)
- zur Hinterleuchtung, Lichtleiter- und Linseneinkopplung
- beide Leuchtdiodenchips getrennt ansteuerbar
- hohe Signalwirkung durch Farbwechsel der LED möglich
- bei geeigneter Ansteuerung sind Farbwechsel möglich
- für alle SMT-Bestück- und Löttechniken geeignet
- gegurtet (8-mm-Filmgurt)
- Störimpulsfest nach DIN 4083

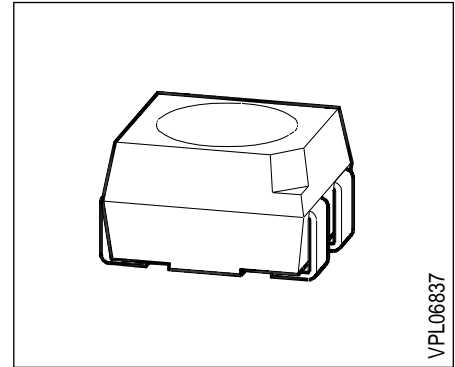

Features

- P-LCC-4 package
- color of package: white
- for use as optical indicator
- appropriate for high ambient light because of the higher operation current (≤ 50 mA DC)
- for backlighting, optical coupling into light pipes and lenses
- both chips can be controlled separately
- high signal efficiency possible by color change of the LED
- with appropriate controlling color changes possible
- suitable for all SMT assembly and soldering methods
- available taped on reel (8 mm tape)
- load dump resistant acc. to DIN 40839

Typ	Emissions- farbe	Farbe der Lichtaustritts- fläche	Lichtstärke	Lichtstrom	Bestellnummer
Type	Color of Emission	Color of the Light Emitting Area	Luminous Intensity $I_F = 50 \text{ mA}$ $I_V(\text{mcd})$	Luminous Flux $I_F = 50 \text{ mA}$ $\Phi_V(\text{mlm})$	Ordering Code
LSG T672-MO	super-red / green	colorless clear	≥ 16 (30 typ.)	90 (typ.)	Q62703-Q2533
LSP T672-KN	super-red / pure green	colorless clear	6.3 ... 50.0	-	Q62703-Q3907
LSP T672-L			10.0 ... 20.0	45 (typ.)	Q62703-Q2778
LSP T672-M			16.0 ... 32.0	75 (typ.)	Q62703-Q2779
LSP T672-N			25.0 ... 50.0	100 (typ.)	Q62703-Q2780
LSP T672-LP			10.0 ... 80.0	-	Q62703-Q2534
■ LOY T672-MO	orange / yellow	colorless clear	≥ 16 (50 typ.)	150 (typ.)	Q62703-Q2535
LOG T672-MO	orange / green	colorless clear	≥ 16 (50 typ.)	150 (typ.)	Q62703-Q2873
LOP T672-KN	orange / pure green	colorless clear	6.3 ... 50.0	-	Q62703-Q2872
LOP T672-L			10.0 ... 20.0	45 (typ.)	Q62703-Q2876
LOP T672-M			16.0 ... 32.0	75 (typ.)	Q62703-Q2877
LOP T672-N			25.0 ... 50.0	100 (typ.)	Q62703-Q2878
LOP T672-LP			10.0 ... 80.0	-	Q62703-Q3099
LYP T672-LO	yellow / pure green	colorless clear	≥ 10 (20 typ.)	60 (typ.)	Q62703-Q2874

■ Not for new design / Nicht für Neuentwicklungen

Streuung der Lichtstärke in einer Verpackungseinheit $I_{V \max} / I_{V \min} \leq 2.0$.¹⁾

Streuung der Lichtstärke in einer LED $I_{V \max} / I_{V \min} \leq 3.0$ (LOY T672, LSG T672, LOG T672), ≤ 4.0 (LSP T672, LOP T672, LYP T672).

¹⁾ Bei MULTILED® bestimmt die Helligkeit des jeweils dunkleren Chips in einem Gehäuse die Helligkeitsgruppe der LED.

Luminous intensity ratio in one packaging unit $I_{V \max} / I_{V \min} \leq 2.0$.¹⁾

Luminous intensity ratio in one LED $I_{V \max} / I_{V \min} \leq 3.0$ (LOY T672, LSG T672, LOG T672), ≤ 4.0 (LSP T672, LOP T672, LYP T672).

¹⁾ In case of MULTILED®, the brightness of the darker chip in one package determines the brightness group of the LED.

Grenzwerte Maximum Ratings

Bezeichnung Parameter	Symbol Symbol	Werte Values	Einheit Unit
Betriebstemperatur Operating temperature range	T_{op}	- 55 ... + 100	°C
Lagertemperatur Storage temperature range	T_{stg}	- 55 ... + 100	°C
Sperrschichttemperatur Junction temperature	T_j	+ 100	°C
Durchlaßstrom Forward current	I_F	50	mA
Stoßstrom Surge current $t \leq 10 \mu s, D = 0.005$	I_{FM}	1	A
Sperrspannung Reverse voltage	V_R	5	V
Verlustleistung Power dissipation	P_{tot}	140	mW
Wärmewiderstand Thermal resistance Sperrschicht / Umgebung Junction / air Montage auf PC-Board*) (Padgröße je $\geq 16 \text{ mm}^2$) mounted on PC board*) (pad size $\geq 16 \text{ mm}^2$ each)	$R_{th JA}^{1)}$ $R_{th JA}^{2)}$	380 530	K/W K/W

*) PC-board: FR4

1) nur ein Chip betrieben

1) one system only

2) beide Chips betrieben

2) both systems on simultaneously

Notes

Die angegebenen Grenzdaten gelten für einen Chip.

The stated maximum ratings refer to one chip.

Kennworte ($T_A = 25\text{ °C}$)

Characteristics

Bezeichnung Parameter	Symbol Symbol	Werte Values					Einheit Unit
		LS	LO	LY	LG	LP	
Wellenlänge des emittierten Lichtes (typ.) Wavelength at peak emission (typ.) $I_F = 10\text{ mA}$	λ_{peak}	635	610	586	565	557	nm
Dominantwellenlänge (typ.) Dominant wavelength (typ.) $I_F = 10\text{ mA}$	λ_{dom}	628	605	590	570	560	nm
Spektrale Bandbreite bei 50 % $I_{\text{rel max}}$ (typ.) Spectral bandwidth at 50 % $I_{\text{rel max}}$ (typ.) $I_F = 10\text{ mA}$	$\Delta\lambda$	45	40	45	25	22	nm
Abstrahlwinkel bei 50 % I_V (Vollwinkel) Viewing angle at 50 % I_V	2ϕ	120	120	120	120	120	Grad deg.
Durchlaßspannung (typ.) Forward voltage (max.) $I_F = 50\text{ mA}$	V_F V_F	2.0 3.8	2.1 3.8	2.2 3.8	2.6 3.8	2.6 3.8*)	V V
Sperrstrom (typ.) Reverse current (max.) $V_R = 5\text{ V}$	I_R I_R	0.01 10	0.01 10	0.01 10	0.01 10	0.01 10	μA μA
Kapazität (typ.) Capacitance $V_R = 0\text{ V}, f = 1\text{ MHz}$	C_0	40	35	35	60	80	pF
Schaltzeiten: Switching times: I_V from 10 % to 90 % (typ.) I_V from 90 % to 10 % (typ.) $I_F = 100\text{ mA}, t_p = 10\text{ }\mu\text{s}, R_L = 50\text{ }\Omega$	t_r t_f	350 200	500 250	350 200	500 250	500 250	ns ns

*) $V_F \text{ max} = 3.2\text{ V}$ as of Febr. 97

Relative spektrale Emission $I_{rel} = f(\lambda)$, $T_A = 25\text{ °C}$, $I_F = 10\text{ mA}$

Relative spectral emission

$V(\lambda)$ = spektrale Augenempfindlichkeit

Standard eye response curve

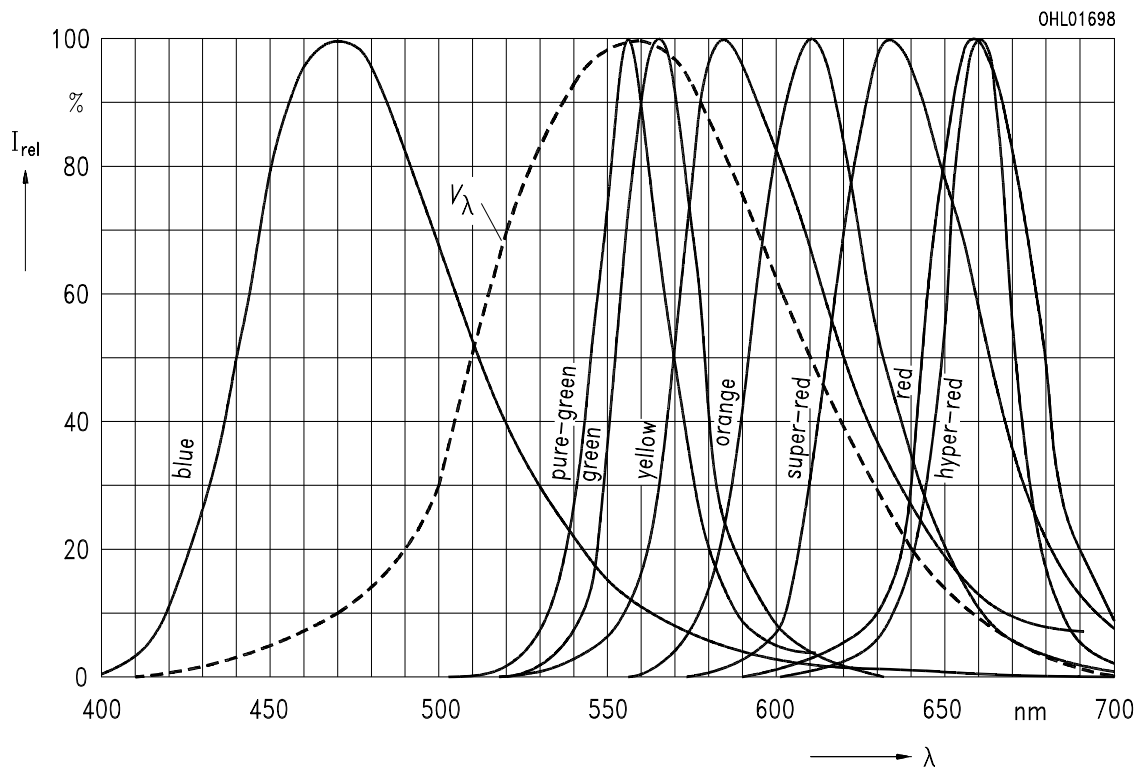

Abstrahlcharakteristik $I_{rel} = f(\varphi)$

Radiation characteristic

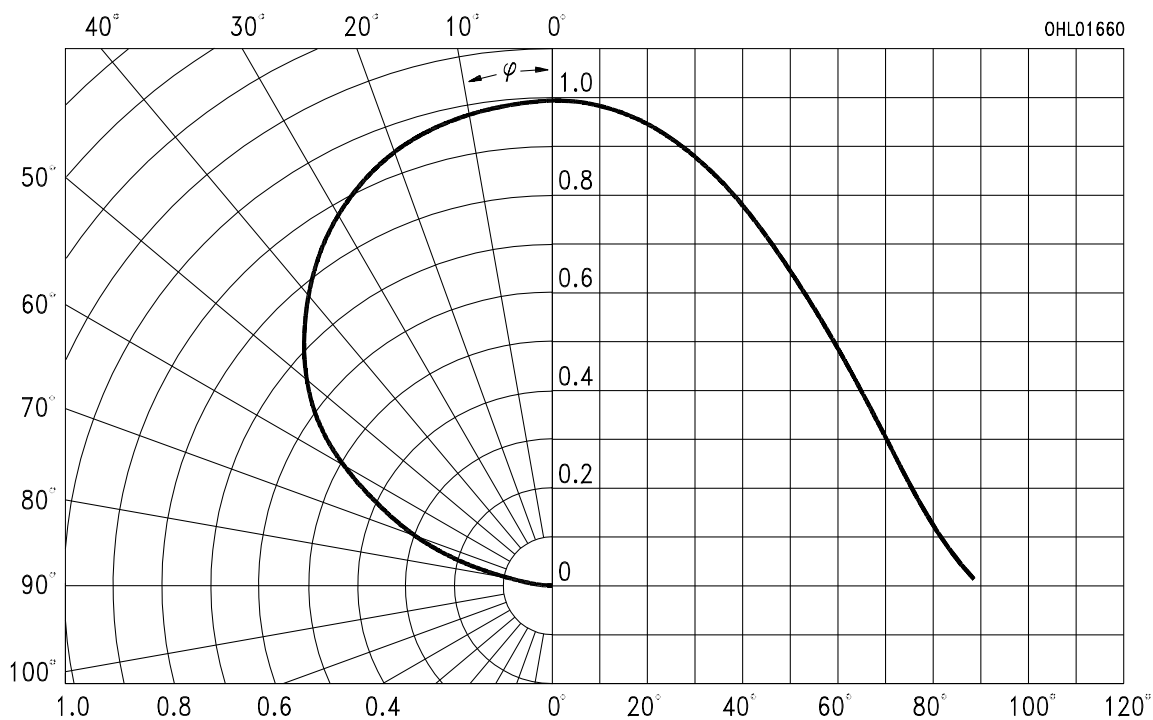

Durchlaßstrom $I_F = f(V_F)$

Forward current

$T_A = 25^\circ\text{C}$

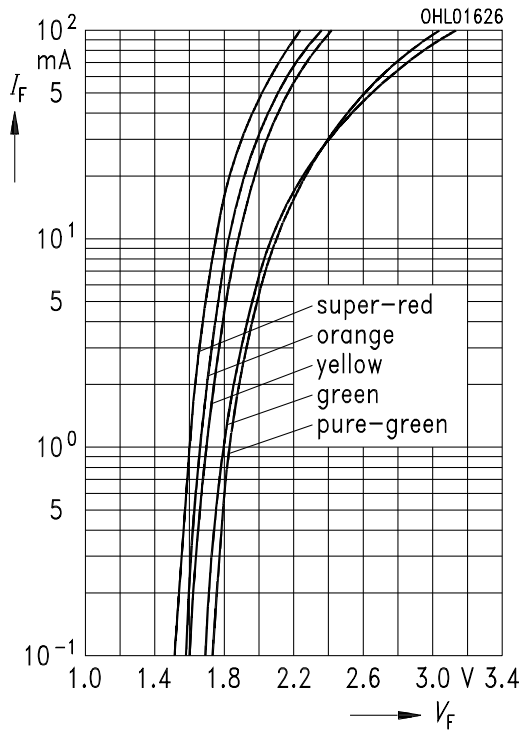

Relative Lichtstärke $I_V / I_{V(50\text{mA})} = f(I_F)$

Relative luminous intensity

$T_A = 25^\circ\text{C}$

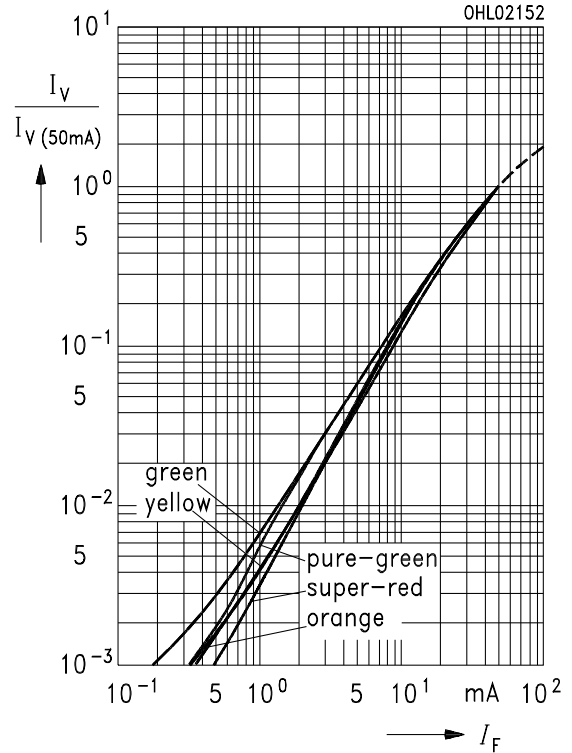

Zulässige Impulsbelastbarkeit $I_F = f(t_p)$

Permissible pulse handling capability

Duty cycle $D =$ parameter, $T_A = 25^\circ\text{C}$

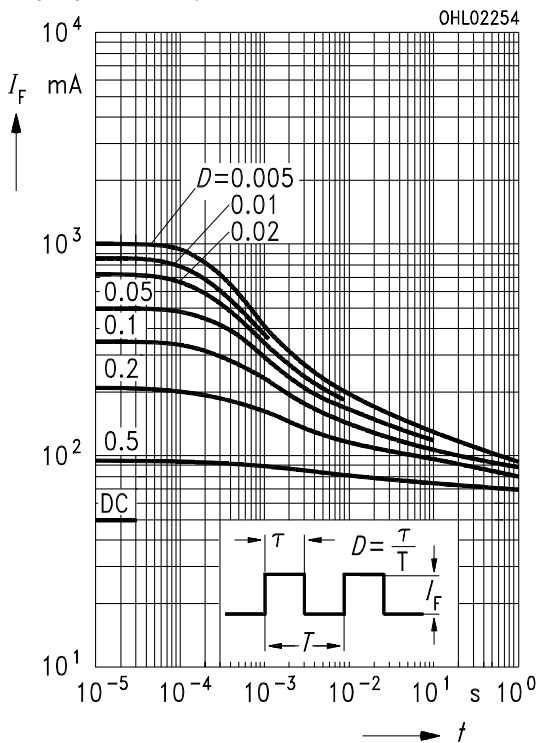

Maximal zulässiger Durchlaßstrom $I_F = f(T_A)$

Max. permissible forward current

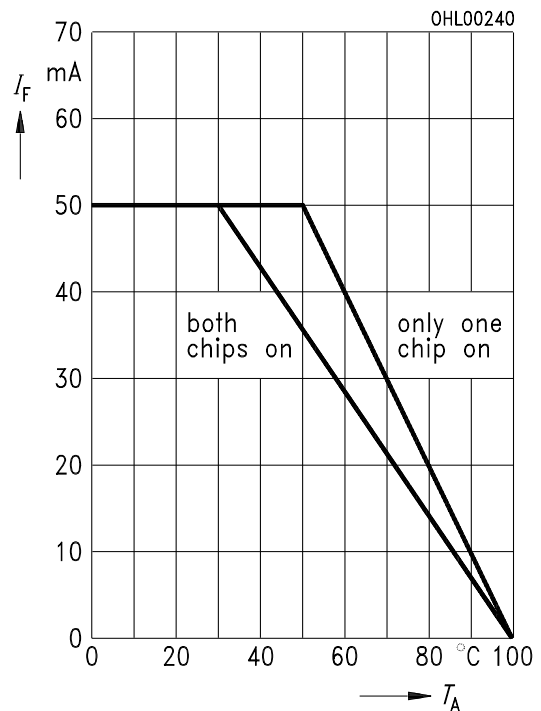

Wellenlänge der Stahlung $\lambda_{\text{peak}} = f(T_A)$
Wavelength at peak emission

$I_F = 10 \text{ mA}$

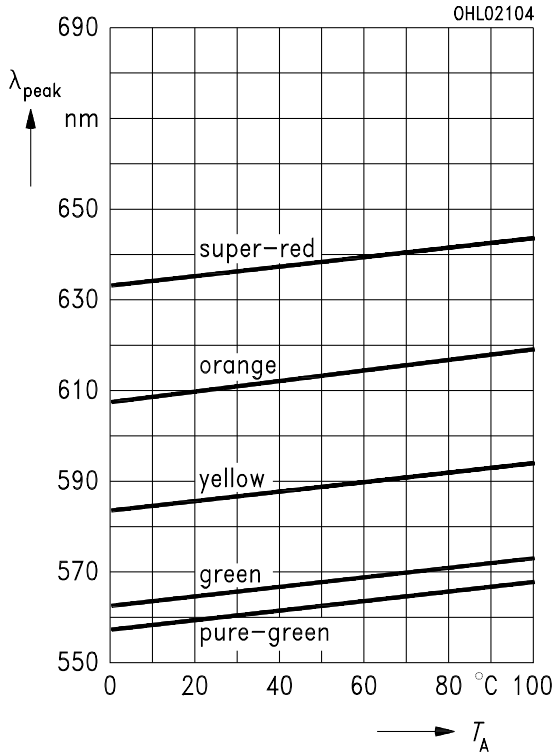

Dominantwellenlänge $\lambda_{\text{dom}} = f(T_A)$
Dominant wavelength

$I_F = 10 \text{ mA}$

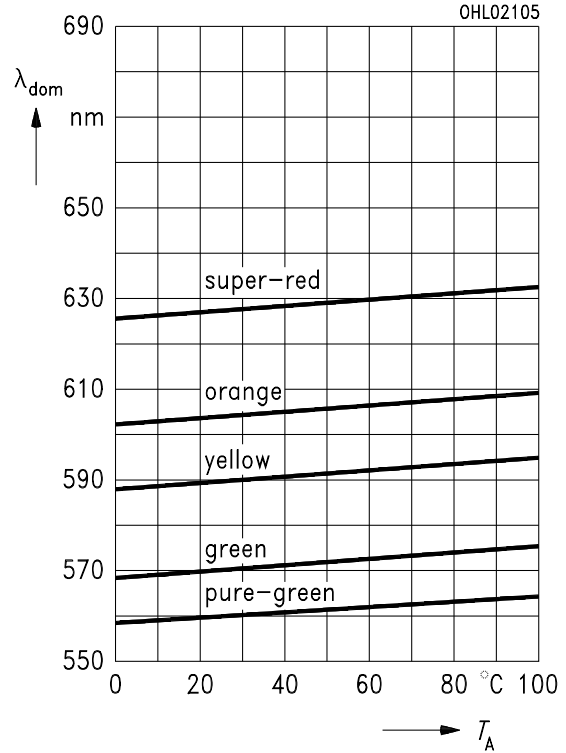

Durchlaßspannung $V_F = f(T_A)$
Forward voltage

$I_F = 50 \text{ mA}$

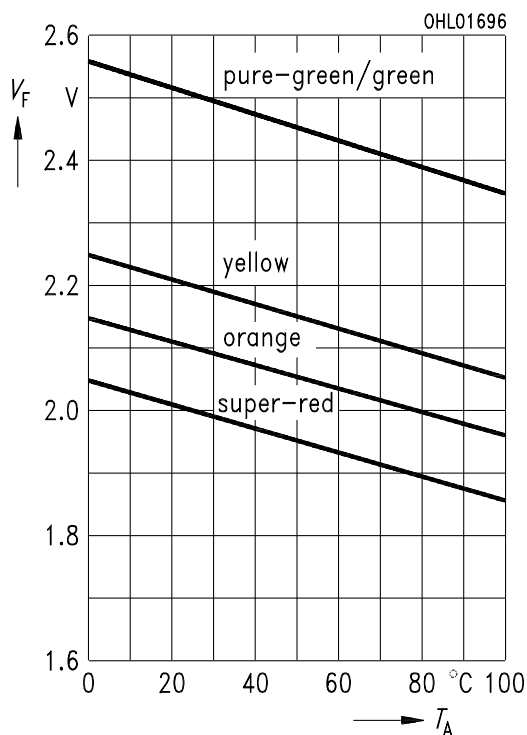

Relative Lichtstärke $I_V / I_{V(25^\circ\text{C})} = f(T_A)$
Relative luminous intensity

$I_F = 50 \text{ mA}$

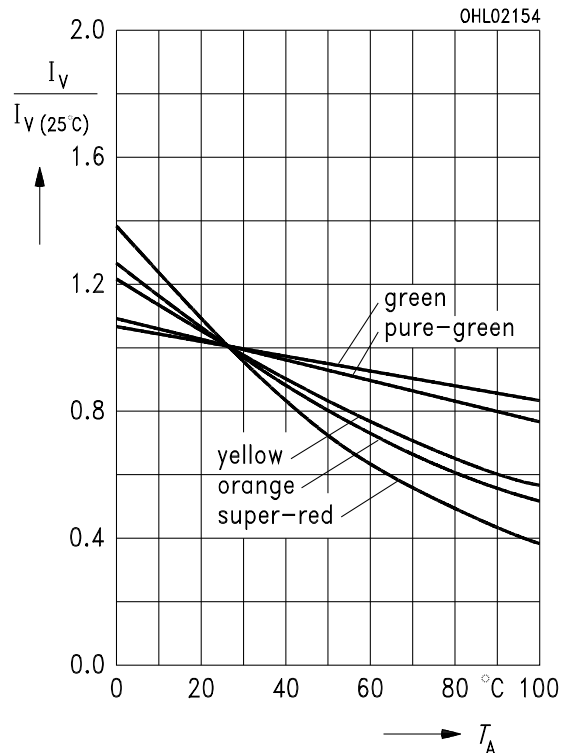

Maßzeichnung (Maße in mm, wenn nicht anders angegeben)
Package Outlines (Dimensions in mm, unless otherwise specified)

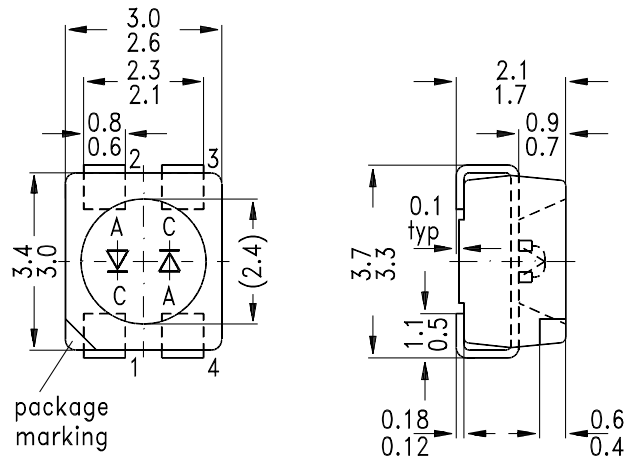

L	O	Y	T672
LED	Emission color 1	Emission color 2	Package
	cathode: pin 1	cathode: pin 3	

GPL06837