



POSEICO SPA  
Power SEmiconductors Italian COrporation

POSEICO SPA  
Via N. Lorenzi 8, 16152 Genova - ITALY  
Tel. ++ 39 010 6556234 - Fax ++ 39 010 6557519  
Sales Office:  
Tel. ++ 39 010 6556775 - Fax ++ 39 010 6442510

**RECTIFIER DIODE**

**AR670**

Repetitive voltage up to **4400 V**  
Mean forward current **2280 A**  
Surge current **22 kA**

**FINAL SPECIFICATION**

nov 02 - ISSUE : 03

Symbol	Characteristic	Conditions	T <sub>j</sub> [°C]	Value	Unit
<b>BLOCKING</b>					
V <sub>RRM</sub>	Repetitive peak reverse voltage		150	4400	V
V <sub>RSM</sub>	Non-repetitive peak reverse voltage		150	4500	V
I <sub>RRM</sub>	Repetitive peak reverse current	V=VRRM	150	200	mA
<b>CONDUCTING</b>					
I <sub>F(AV)</sub>	Mean forward current	180° sin ,50 Hz, Th=55°C, double side cooled		2280	A
I <sub>F(AV)</sub>	Mean forward current	180° sin ,50 Hz, Tc=85°C, double side cooled		2220	A
I <sub>FSM</sub>	Surge forward current	Sine wave, 10 ms without reverse voltage	150	22	kA
I <sup>2</sup> t	I <sup>2</sup> t			2420 x 1E3	A <sup>2</sup> s
V <sub>FM</sub>	Forward voltage	Forward current = 3000 A	25	1.50	V
V <sub>F(TO)</sub>	Threshold voltage		150	0.80	V
r <sub>F</sub>	Forward slope resistance		150	0.210	mohm
<b>SWITCHING</b>					
t <sub>rr</sub>	Reverse recovery time				µs
Q <sub>rr</sub>	Reverse recovery charge		150		µC
I <sub>rr</sub>	Peak reverse recovery current				A
<b>MOUNTING</b>					
R <sub>th(j-h)</sub>	Thermal impedance, DC	Junction to heatsink, double side cooled		21	°C/kW
R <sub>th(c-h)</sub>	Thermal impedance	Case to heatsink, double side cooled		6	°C/kW
T <sub>j</sub>	Operating junction temperature			-30 / 150	°C
F	Mounting force			22.0 / 24.5	kN
	Mass			500	g

**ORDERING INFORMATION : AR670 S 44**

standard specification   VRRM/100

## DISSIPATION CHARACTERISTICS

SQUARE WAVE

Th [°C]

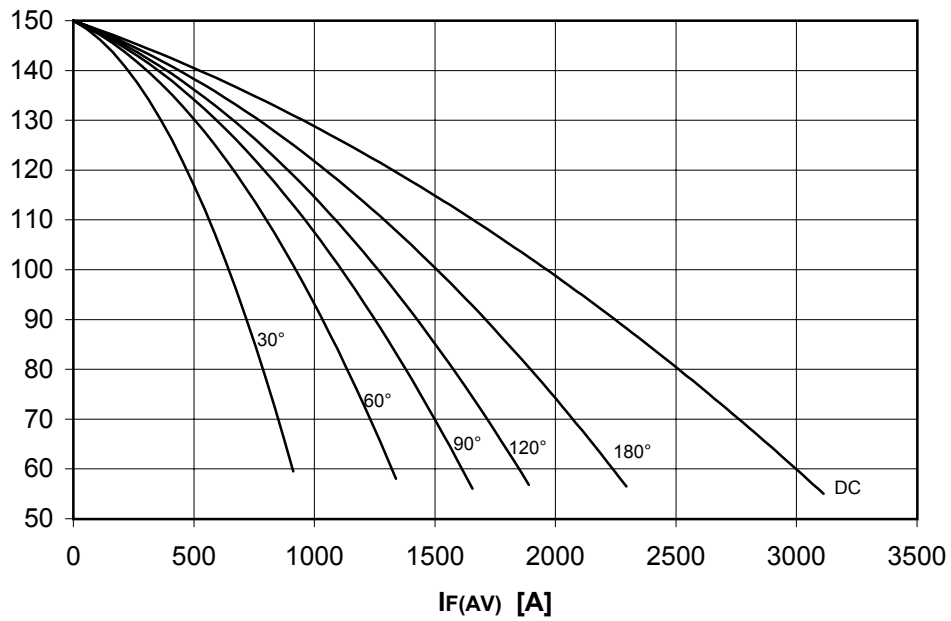

PF(AV) [W]

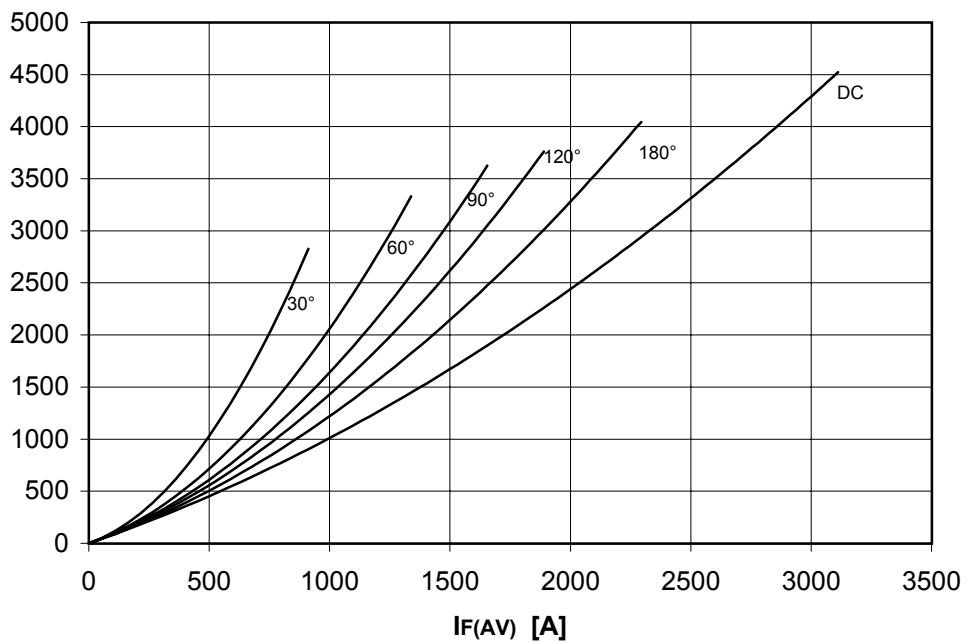

## DISSIPATION CHARACTERISTICS

SINE WAVE

Th [°C]

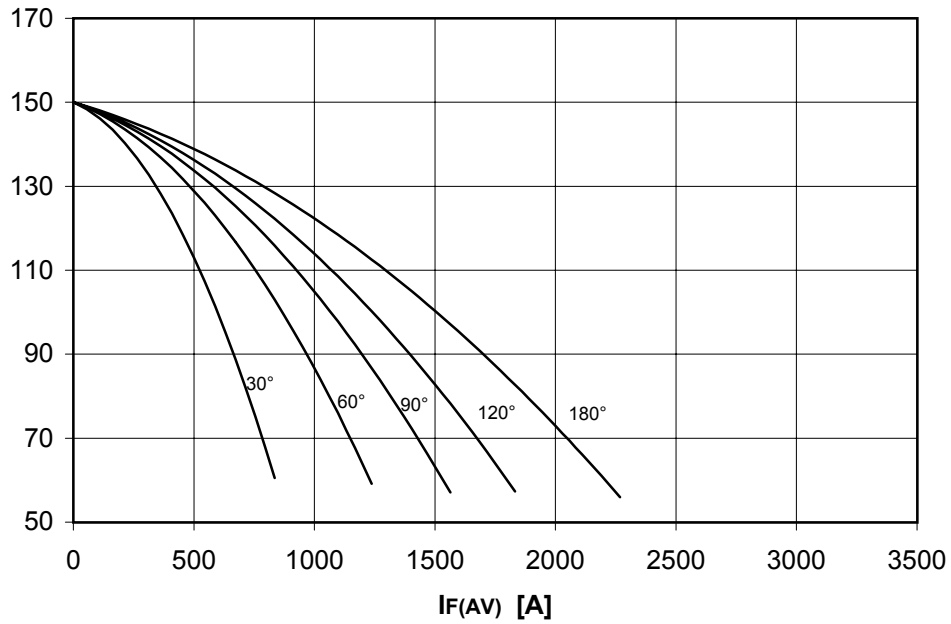

PF(AV) [W]

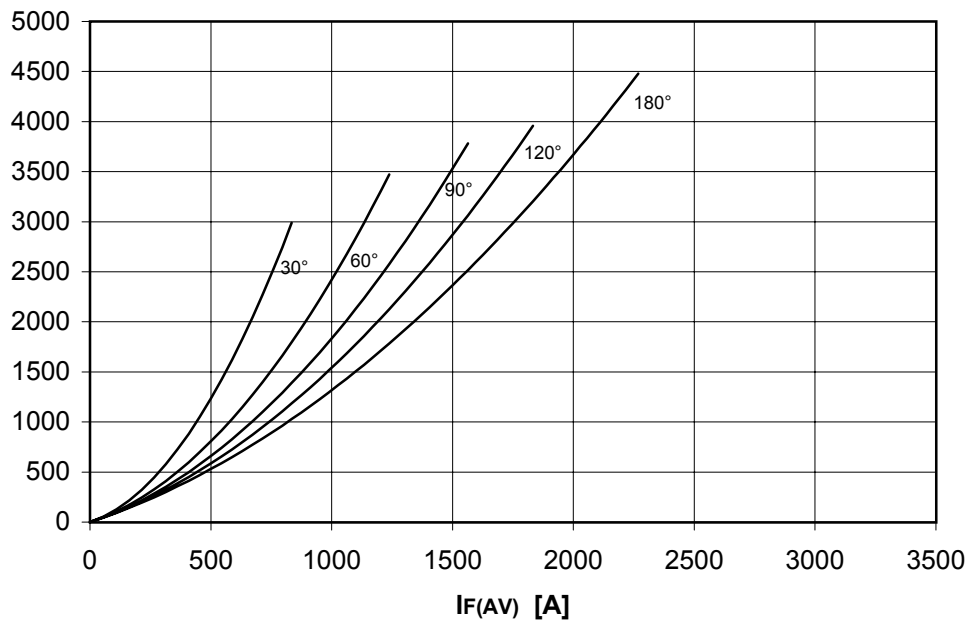

# AR670 RECTIFIER DIODE

FINAL SPECIFICATION nov 02 - ISSUE : 03

FORWARD CHARACTERISTIC  
 $T_J = 150\text{ }^\circ\text{C}$

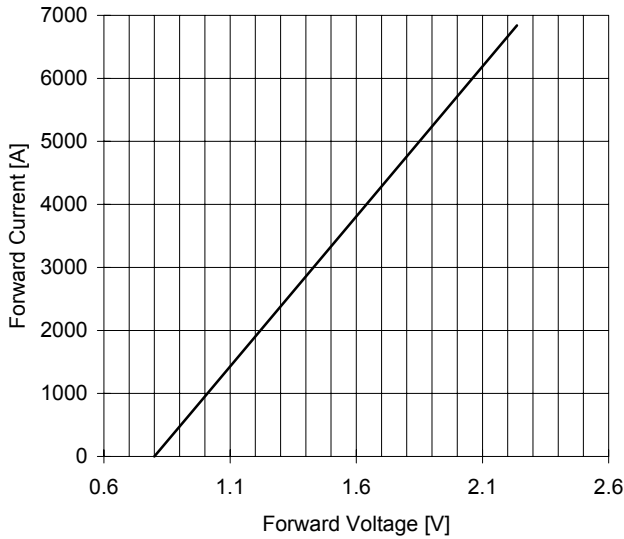

SURGE CHARACTERISTIC  
 $T_J = 150\text{ }^\circ\text{C}$

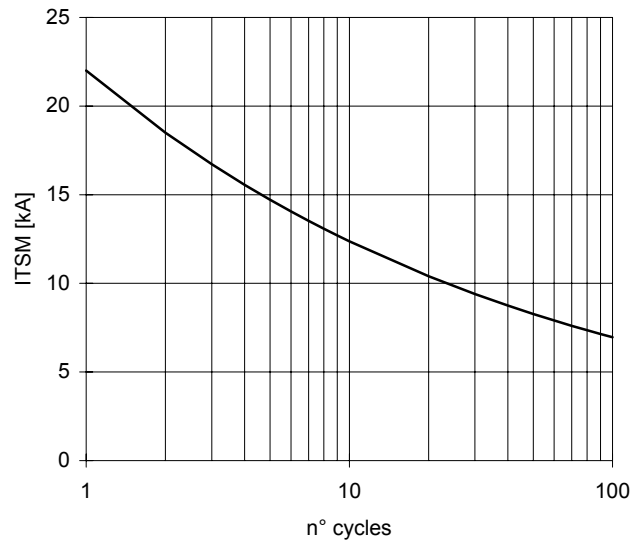

TRANSIENT THERMAL IMPEDANCE  
DOUBLE SIDE COOLED

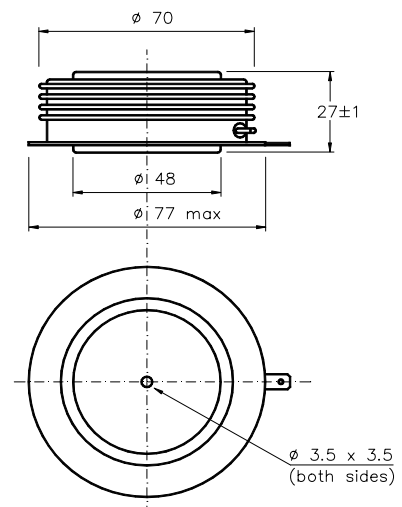
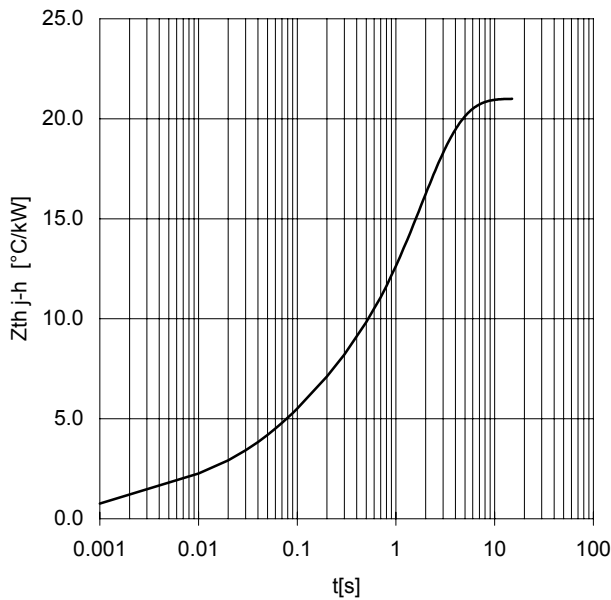

Dimensions  
in mm



All the characteristics given in this data sheet are guaranteed only with uniform clamping force, cleaned and lubricated heatsink, surfaces with flatness <math>< .03\text{ }\mu\text{m}</math> and roughness <math>< 2\text{ }\mu\text{m}</math>.

In the interest of product improvement POSEICO SpA reserves the right to change any data given in this data sheet at any time without previous notice.

If not stated otherwise the maximum value of ratings (symbols over shaded background) and characteristics is reported.

Distributed by

