

Rectifier Diode

W2054NC360 to W2054NC450

The data sheet on the subsequent pages of this document is a scanned copy of existing data for this product.

(Rating Report 97D05 Issue 1)

This data reflects the old part number for this product which is: SW36-45CXC920. This part number must **NOT** be used for ordering purposes – please use the ordering particulars detailed below.

The limitations of this data are as follows:
No recovery data available in this datasheet

Please use the following link to view an up to date outline drawing for this device
[Outline W5](#)

Where any information on the product matrix page differs from that in the following data, the product matrix must be considered correct

An electronic data sheet for this product is presently in preparation.

For further information on this product, please contact your local ASM or distributor.

Alternatively, please contact Westcode as detailed below.

Ordering Particulars			
W2054	NC	◆◆	0
Fixed Type Code	Fixed Outline Code	Voltage code $V_{RRM}/100$ 36-45	Fixed Code
Typical Order Code: W2054NC360, 27.7mm clamp height, 3600V V_{RRM}			

<p>IXYS Semiconductor GmbH Edisonstraße 15 D-68623 Lampertheim Tel: +49 6206 503-0 Fax: +49 6206 503-627 E-mail: marcom@ixys.de</p>	<p style="font-size: 1.2em; margin: 0;">An IXYS Company</p> <p style="margin: 10px 0 0 0;">www.westcode.com</p> <p style="margin: 0 0 0 0;">www.ixys.com</p>	<p>Westcode Semiconductors Ltd Langley Park Way, Langley Park, Chippenham, Wiltshire, SN15 1GE. Tel: +44 (0)1249 444524 Fax: +44 (0)1249 659448 E-mail: WSL.sales@westcode.com</p> <p>Westcode Semiconductors Inc 3270 Cherry Avenue Long Beach CA 90807 USA Tel: +1 (562) 595 6971 Fax: +1 (562) 595 8182 E-mail: WSI.sales@westcode.com</p>
<p>The information contained herein is confidential and is protected by Copyright. The information may not be used or disclosed except with the written permission of and in the manner permitted by the proprietors Westcode Semiconductors Ltd. © Westcode Semiconductors Ltd.</p> <p>In the interest of product improvement, Westcode reserves the right to change specifications at any time without prior notice.</p> <p>Devices with a suffix code (2-letter, 3-letter or letter/digit/letter combination) added to their generic code are not necessarily subject to the conditions and limits contained in this report.</p>		

Rectifier Diode Type SW36-45CXC920

	VOLTAGE RATINGS	MAXIMUM LIMITS	UNITS
V_{RRM}	Repetitive peak reverse voltage, (note 1).	3600-4500	V
V_{RSM}	Non-repetitive peak reverse voltage, (note 1).	3700-4600	V

	RATINGS	MAXIMUM LIMITS	UNITS
$I_{F(AV)}$	Mean on-state current, $T_{HS}= 55^{\circ}C, 100^{\circ}C$. (Note 2)	2055, 1455	A
$I_{F(AV)}$	Mean on-state current, $T_{HS}= 100^{\circ}C$ (Note 3)	920	A
$I_{F(RMS)}$	Nominal RMS on-state current, $T_{HS}= 25^{\circ}C$. (Note 2)	3750	A
$I_{F(D.C.)}$	D.C. on-state current, $T_{HS}= 25^{\circ}C$. (Note 5)	3380	A
I_{FSM1}	Peak non-repetitive surge $t_p=10ms, V_{RM}=0.6V_{RRM}$, (note 4).	19000	A
I_{FSM2}	Peak non-repetitive surge $t_p=10ms, V_{RM}\leq 10V$, (note 4).	20900	A
I^2t	I^2t capacity for fusing $t_p=10ms, V_{RM}=0.6V_{RRM}$, (note 4).	1.81×10^6	A^2s
I^2t	I^2t capacity for fusing $t_p=10ms, V_{RM}\leq 10V$, (note 4).	2.19×10^6	A^2s
I^2t	I^2t capacity for fusing $t_p=3ms, V_{RM}\leq 10V$, (note 4).	1.62×10^6	A^2s
T_{HS}	Operating temperature range.	-40 to +160	$^{\circ}C$
T_{stg}	Storage temperature range.	-40 to +160	$^{\circ}C$

Notes:-

- 1) De-rating factor of 0.13% per K is applicable for T_j below $25^{\circ}C$.
- 2) Double sided cooled, single phase; 50Hz, 180° half-sinewave.
- 3) Single sided cooled, single phase; 50Hz 180° half-sinewave.
- 4) Half-sinewave, $160^{\circ}C$ T_j initial.
- 5) Double sided cooled.

	CHARACTERISTICS	MIN	TYP	MAX	TEST CONDITIONS	UNITS
V_{FM}	Maximum peak on-state voltage.	-	-	1.7	$I_{FM} = 3000A.$	V
V_0	Threshold voltage.	-	-	0.80		V
R_s	Slope resistance.	-	-	0.30		m Ω
I_{BRM}	Peak reverse current.	-	-	50	Rated V_{RRM}	mA
R_{θ}	Thermal resistance junction to heatsink	-	-	0.022	Double sided cooled	K/W
	Thermal resistance junction to heatsink	-	-	0.044	Single sided cooled	K/W
F	Mounting force.	19	-	26		kN
W_t	Weight.	-	510	-		g

Notes:-

- 1) Unless otherwise indicated $T_j = 160^{\circ}C.$

Contents

	<u>Page</u>
Introduction	1
Ratings	2
Characteristics	3
Contents	4
Voltage Rating Information	5
Computer Modelling Parameters	
Device Dissipation Calculations	5
ABCD Coefficients	6
Thermal Impedance Calculations	6
Mean Forward Current vs Power Dissipation Double Sided Cooled	7
Mean Forward Current vs Heatsink Temperature Double Sided Cooled	7
Mean Forward Current vs Power Dissipation Single Sided Cooled	8
Mean Forward Current vs Heatsink Temperature Single Sided Cooled	8
Limit Forward Voltage Characteristics	9
Transient Thermal Impedance Characteristic	10
Surge Current and I^2t vs Duration of Surge	11
Layout Drawing & Ordering Information	12

Voltage Ratings

Voltage Grade 'H'	VFSM VFRM VRRM V	VRSM V	VF VR D.C.
36	3600	3700	1900
38	3800	3900	1950
40	4000	4100	2000
42	4200	4300	2040

This report is applicable to other and higher voltage grades when supply has been agreed by Sales/Production.

A blocking voltage de-rating factor of 0.13% per deg Celsius is applicable to this device for T_J below 25 °C.

Computer Modelling Parameters

1. Device Dissipation Calculations

$$I_{AV} = \frac{-V_o + \sqrt{V_o^2 - 4 * ff^2 * r_s * (-W_{AV})}}{2 * ff^2 * r_s}$$

Where V_o = 0.80 V, r_s = 0.30 mOhms

$$W_{AV} = \frac{\Delta T}{R_{th}} \quad \Delta T = t_{jMax} - t_{HS}$$

R_{th} = Supplementary thermal impedance, see table below.

ff = Form factor, see table below.

Supplementary Thermal Impedance						
Conduction Angle	30°	60°	90°	120°	180°	d.c.
Squarewave Double Side Cooled	0.0366	0.0320	0.0292	0.0274	0.0253	0.022
Squarewave Single Side Cooled	0.0582	0.0540	0.0514	0.0497	0.0477	0.044
Sinewave Double Side Cooled	0.0317	0.0271	0.0252	0.0229	0.022	
Sinewave Single Side Cooled	0.0538	0.0496	0.0478	0.0467	0.044	

Form Factors						
Conduction Angle	30°	60°	90°	120°	180°	d.c.
Squarewave	3.46	2.45	2	1.73	1.41	1
Sinewave	3.98	2.78	2.22	1.88	1.57	

2. ABCD Coefficients

The on-state characteristic I_F vs V_F is represented in two ways; (i) the well established V_o and r_s tangent used for rating purposes and (ii) a set of constants A, B, C, D, forming the coefficients of the representative equation for V_F in terms of I_F given as:

$$V_f = A + B \cdot \ln(I_f) + C \cdot (I_f) + D \cdot \sqrt{I_f}$$

The constants, derived by curve fitting software, are given in this report for both hot and cold characteristics where possible. The resulting values for V_F agree with the true device characteristic over a limited current range which is generally that over which the curve is plotted.

160 °C Coefficients		25 °C Coefficients	
A	6.137258×10^{-1}	A	6.866731×10^{-1}
B	-2.801941×10^{-2}	B	1.348722×10^{-2}
C	1.561647×10^{-4}	C	1.199521×10^{-4}
D	1.534938×10^{-2}	D	7.579789×10^{-3}

3. Thermal Impedance Calculations

$$r_t = \sum_{p=1}^{p=n} r_p \left(1 - e^{-\frac{t}{\tau_p}} \right)$$

Where $p = 1$ to n , n is the number of terms in the series.

t = Duration of heating pulse in seconds.

r_t = Thermal resistance at time t .

r_p = Amplitude of p th term.

τ_p = Time Constant of p th term.

D.C. Double Side Cooled					
Term	1	2	3	4	5
r_p	1.155655×10^{-2}	5.055660×10^{-3}	2.503056×10^{-3}	1.549315×10^{-3}	1.736643×10^{-3}
t_p	9.222825×10^{-1}	1.703512×10^{-1}	4.453273×10^{-2}	1.143316×10^{-2}	1.582146×10^{-2}

D.C. Single Side Cooled						
Term	1	2	3	4	5	6
r_p	2.80202×10^{-2}	4.27556×10^{-3}	5.20318×10^{-3}	3.71583×10^{-3}	2.00592×10^{-3}	1.70787×10^{-3}
t_p	5.445761	2.121661	2.48842×10^{-1}	7.61462×10^{-2}	1.40677×10^{-2}	1.71541×10^{-2}

Double Side Cooled

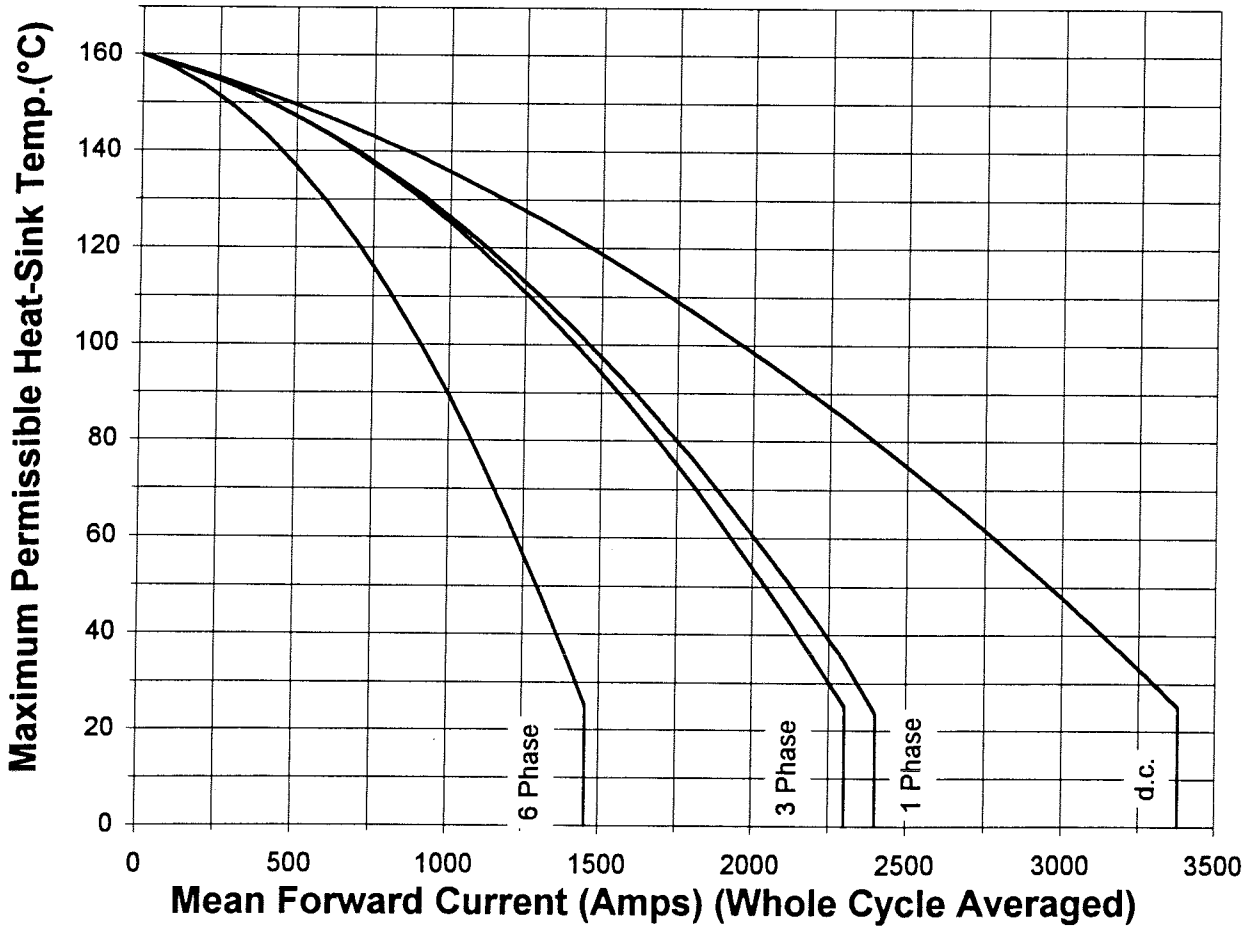
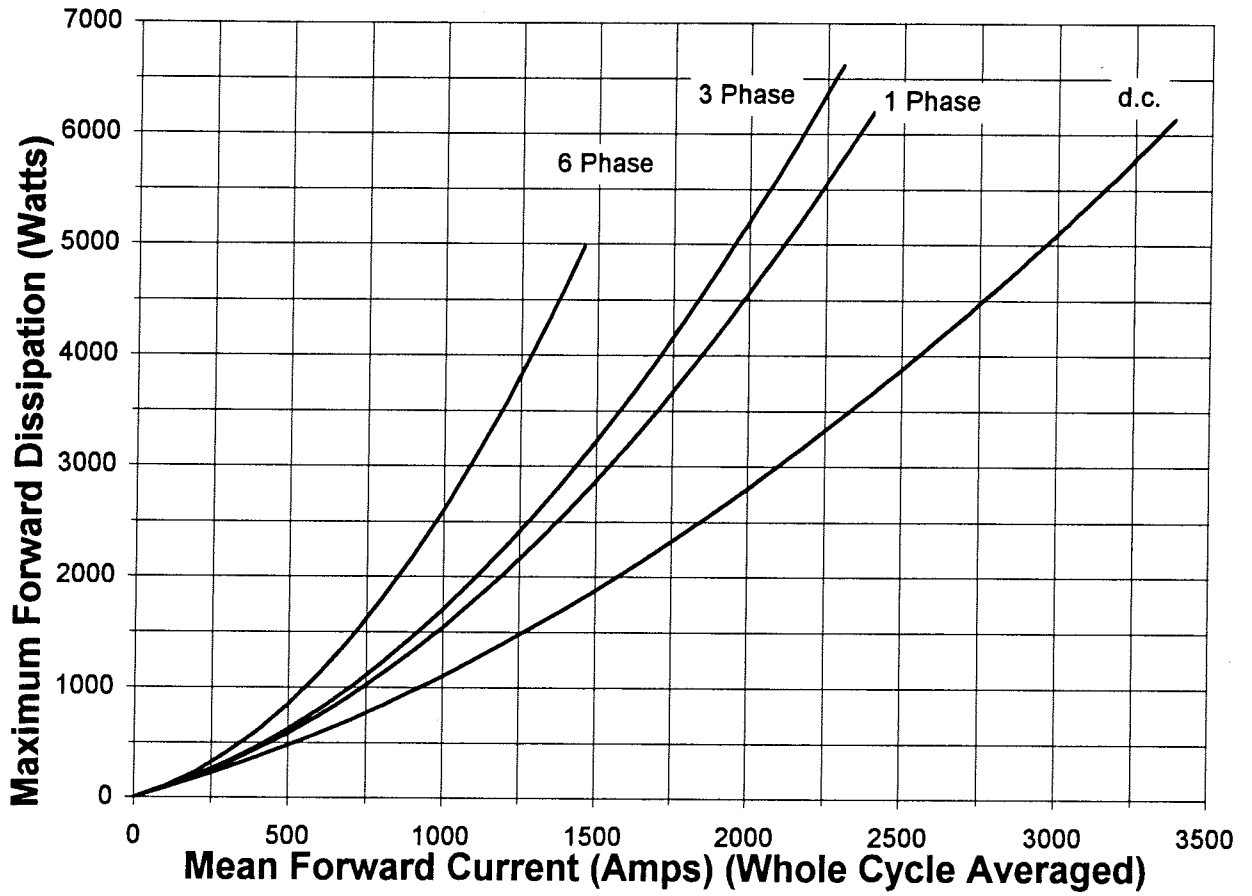

Single Side Cooled

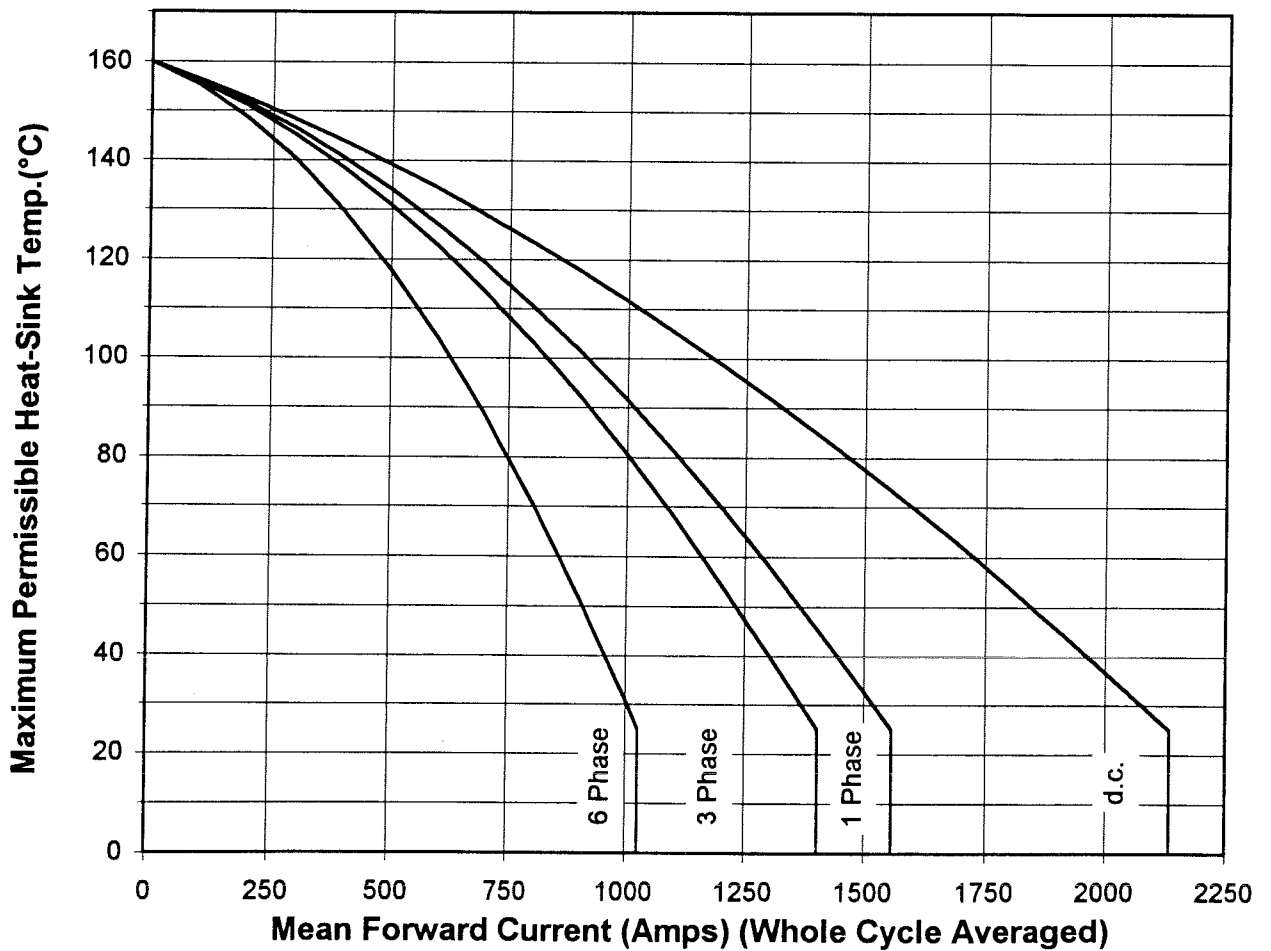
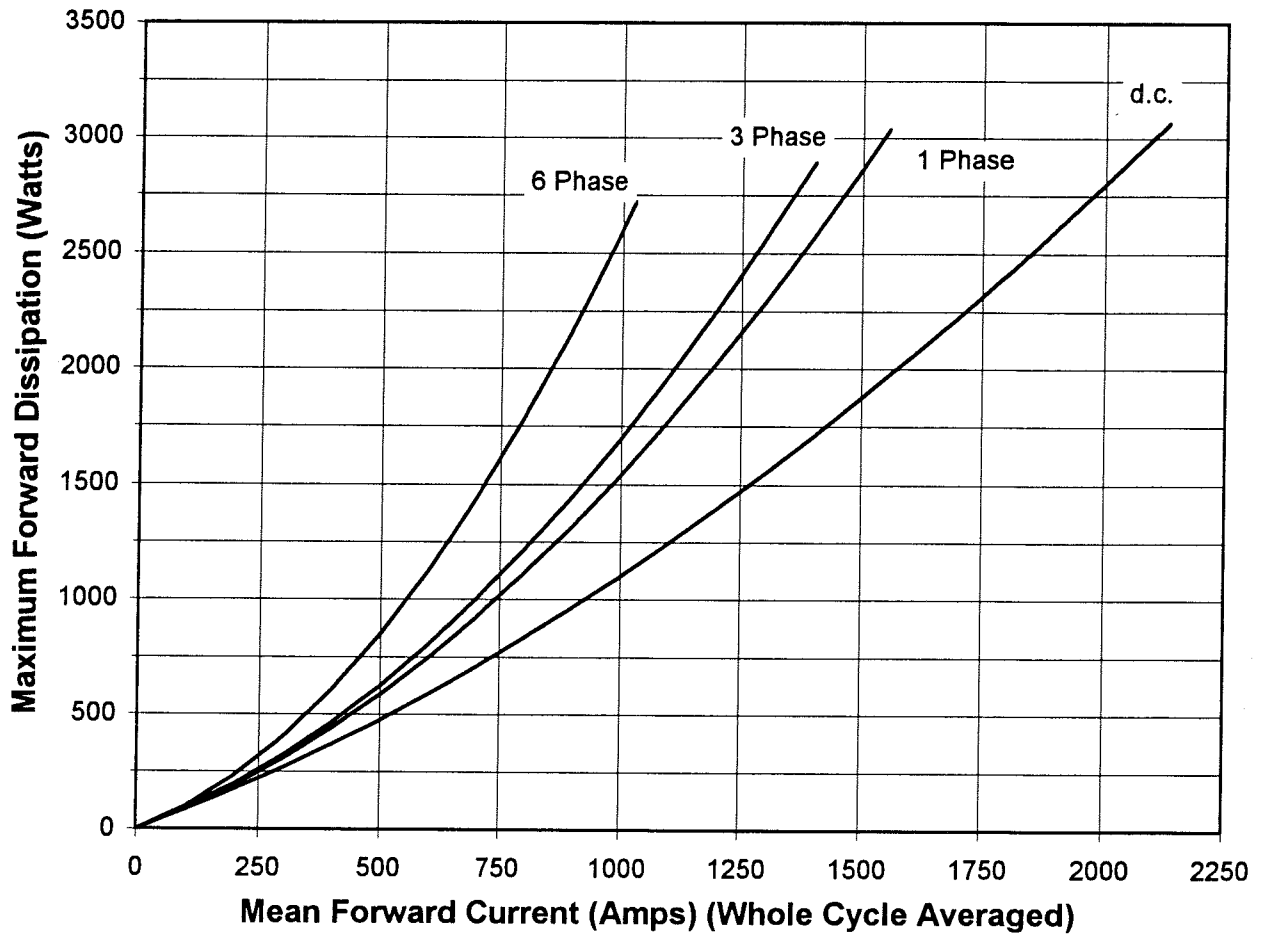

Forward Characteristic of Limit Device

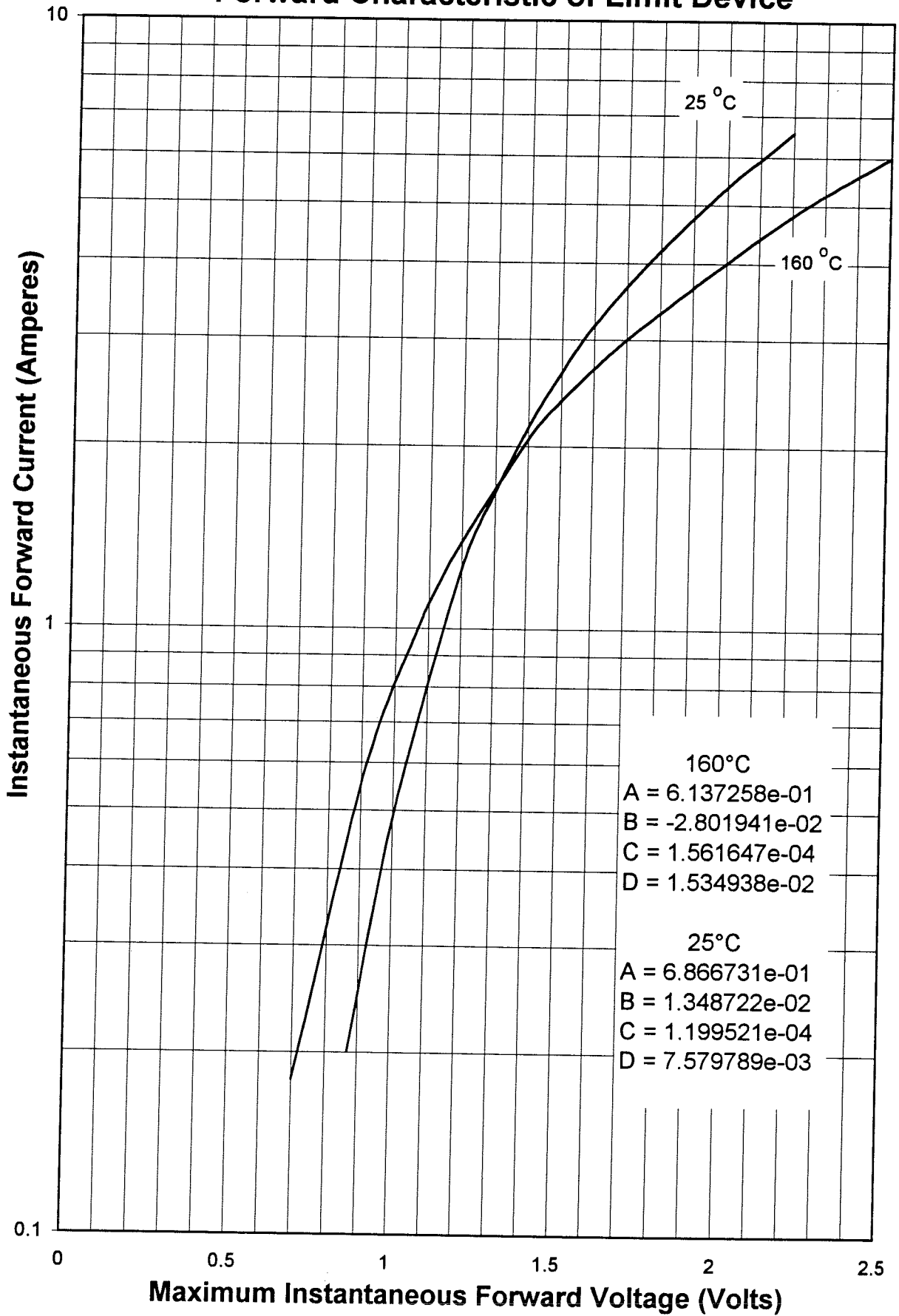

Transient Thermal Impedance (Junction to Heat Sink)

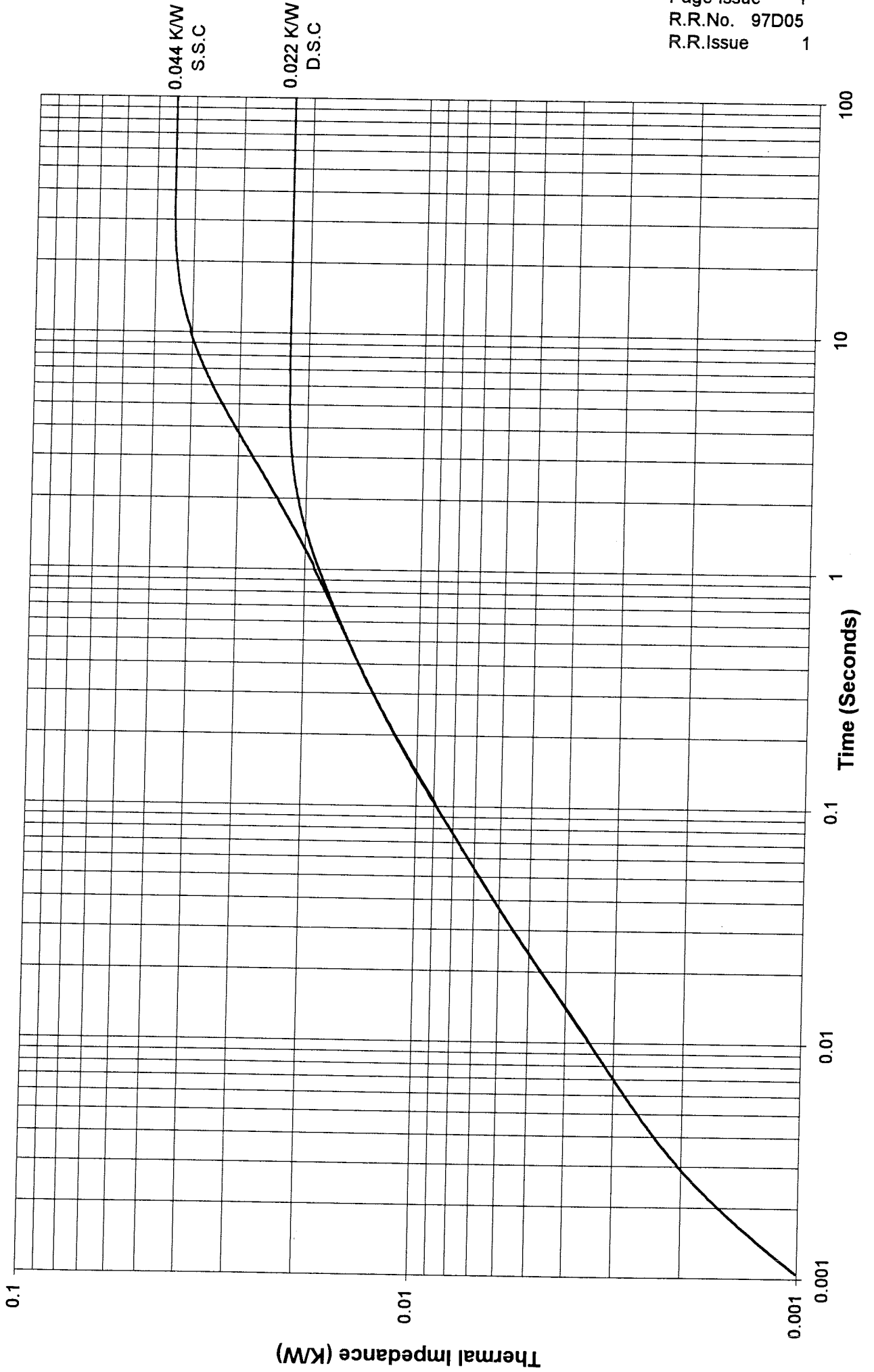

Maximum Non-Repetitive Surge Current @ Initial Junction Temperature 160 °C

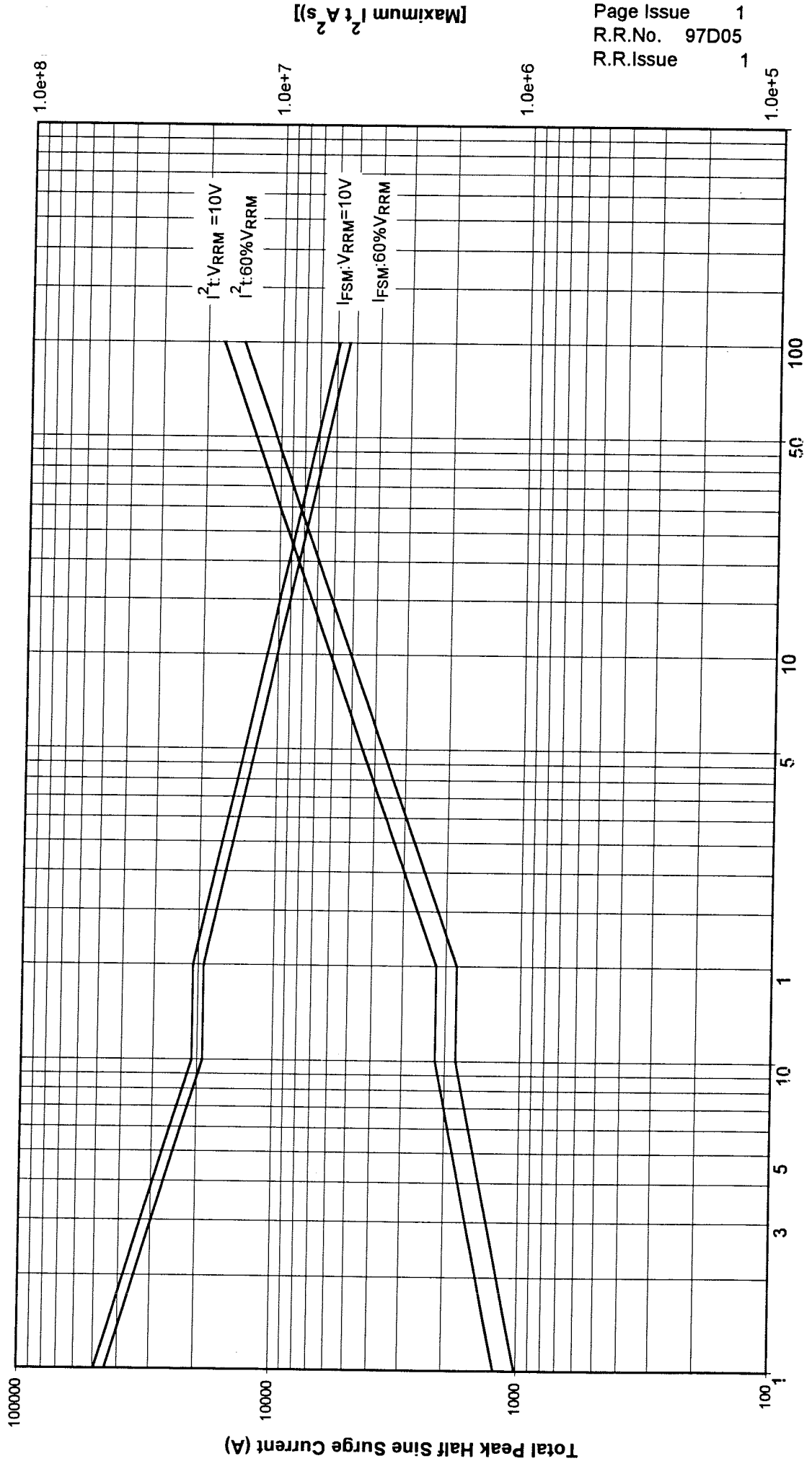

[Maximum $I_{t,A}^{2}$ (s)]

1.0e+8

1.0e+7

1.0e+6

1.0e+5

100000

10000

1000

100

Total Peak Half Sine Surge Current (A)

Duration of Surge (ms)

Duration of Surge (Cycles @ 50 Hz)

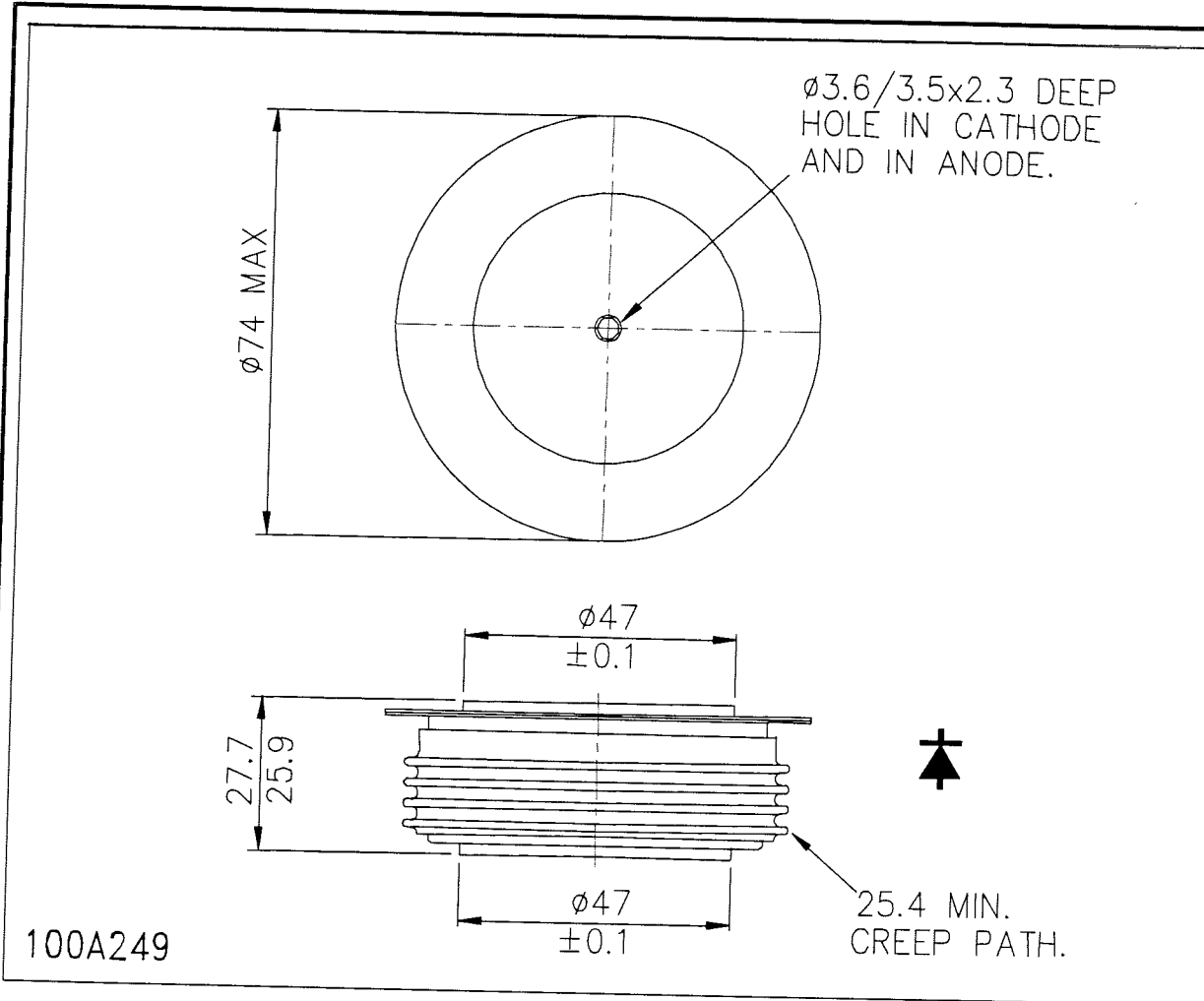

ORDERING INFORMATION

(Please quote 10 digit code as below)

S W	♦ ♦	C X C	9 2 0
Fixed Type Code	Voltage Code (see ratings)	Fixed Outline Code	Fixed Type Code

Typical order code : SW45CXC920, 4500 V_{RRM}

WESTCODE 
SEMICONDUCTORS

WWW: <http://www.westcode.com>

A member of the BTR group

In the interest of Product improvement Westcode reserves the right to change specifications at any time without notice

U.K : Westcode Semiconductors Ltd
P.O. Box 57, Chippenham, Wiltshire, England SN15 1JL
Tel: +44 (0)1249 444524 Fax: +44 (0)1249 659448
E-mail: WSL.sales@btrinc.com

USA : Westcode Semiconductors Inc
3270 Cherry Avenue, Long Beach, California 90807
Tel: 310 595 6971 Fax: 310 595 8182

© Westcode Semiconductors Ltd.