



3583

High Voltage, High Current OPERATIONAL AMPLIFIER

FEATURES

- WIDE POWER SUPPLY VOLTAGE:
 $\pm 70V$ to $\pm 150V$
- OUTPUT CURRENT TO 75mA
- SLEW RATE: $30V/\mu s$
- FET INPUT: $I_B = 20pA$ max
- THERMAL SHUT-DOWN PROTECTION
- HERMETIC TO-3 PACKAGE, ISOLATED CASE

APPLICATIONS

- PROGRAMMABLE POWER SUPPLY
- PIEZO-ELECTRIC TRANSDUCER DRIVER
- HIGH VOLTAGE CURRENT SOURCE

DESCRIPTION

The 3583 is a high voltage, high speed hybrid operational amplifier designed for a wide variety of programmable power supply and transducer driver applications.

The 3583 operates over a wide power supply range ($\pm 50V$ to $\pm 150V$) and provides outputs up to 75mA. Laser-trimmed FET input circuitry provides low offset voltage (3mV max) and low input bias current (20pA max). Thermal shut-down circuitry protects internal circuitry from excessive power dissipation.

Commercial and industrial temperature range models are available. The 3583's hermetic 8-pin TO-3 package is electrically isolated from all internal circuitry.

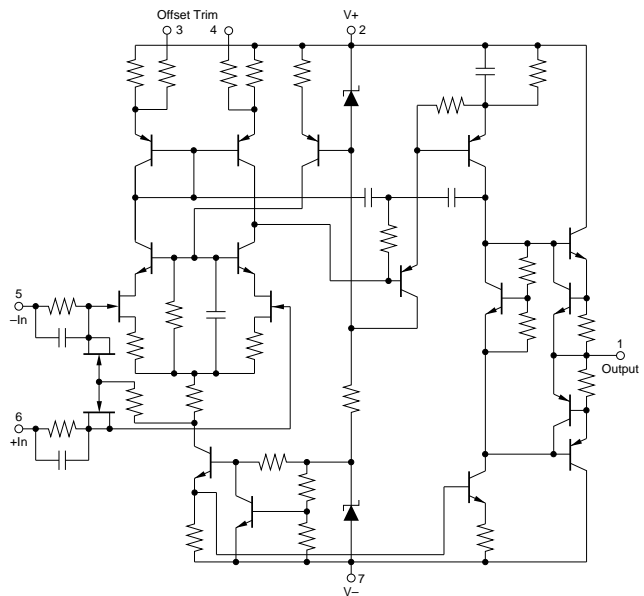

International Airport Industrial Park • Mailing Address: PO Box 11400 • Tucson, AZ 85734 • Street Address: 6730 S. Tucson Blvd. • Tucson, AZ 85706
Tel: (520) 746-1111 • Twx: 910-952-1111 • Cable: BBRCORP • Telex: 066-6491 • FAX: (520) 889-1510 • Immediate Product Info: (800) 548-6132

SPECIFICATIONS

ELECTRICAL

T_{CASE} = +25°C, V_S = ±150V, unless otherwise noted.

PARAMETER	CONDITIONS	3583AM			3583JM			UNITS
		MIN	TYP	MAX	MIN	TYP	MAX	
OFFSET VOLTAGE Input Offset Voltage vs Temperature vs Power Supply vs Time	Specified Temp. Range		20 50	±3 ±23		* *	* *	mV μV/°C μV/V μV/month
INPUT BIAS CURRENT⁽¹⁾ Input Bias Current vs Temperature vs Power Supply Input Offset Current vs Temperature vs Power Supply	V _{CM} = 0V V _{CM} = 0V		Doubles Every 10°C 0.2 Doubles Every 10°C 0.2	-20 ±20		* * * *	* *	pA pA/V pA pA/V
NOISE Voltage, 0.01Hz to 10Hz 10Hz to 1kHz Current, 0.01Hz to 10Hz			5 1.7 0.3			* * *		μVp-p μVrms pAp-p
INPUT VOLTAGE RANGE Max Safe Differential Input Max Safe Common-Mode Input Common-Mode Input Range Common-Mode Rejection	Linear Operation		(V+) + V- V- to V+ V _S -10 110			* * * *		V dB
INPUT IMPEDANCE Differential Common-Mode			10 ¹¹ 10 10 ¹¹			* *		Ω pF Ω pF
OPEN-LOOP GAIN Open-Loop Voltage Gain Open-Loop Voltage Gain	No Load, DC Rated Load, DC		118 105			* *		dB dB
FREQUENCY RESPONSE Unity-Gain Bandwidth Full-Power Bandwidth Slew Rate Settling Time: 0.1%	Small-Signal R _L = 10kΩ		5 60 30 12			* * * *		MHz kHz V/μs μs
OUTPUT Voltage Output Current Output Short Circuit Current Load Capacitance		V _S -10 ±75	±100	10		* * *		V mA mA nF
POWER SUPPLY Operating Voltage Range Quiescent Current	I _O = 0	±50		±150 ±8.5		* *		V mA
TEMPERATURE RANGE (CASE) Specification Operating Storage θ _{JC} = 4°C/W		-25 -55 -55		+85 +125 +125	0 * *		+70 * *	°C °C °C

* Specification same as 3583AM.

NOTE: (1) Inputs may be damaged by input slew rates exceeding 1000V/μs. Inputs can be protected from signals exceeding 1000V/μs by limiting input current to 150mA with external series resistors (pins 5 and 6).

The information provided herein is believed to be reliable; however, BURR-BROWN assumes no responsibility for inaccuracies or omissions. BURR-BROWN assumes no responsibility for the use of this information, and all use of such information shall be entirely at the user's own risk. Prices and specifications are subject to change without notice. No patent rights or licenses to any of the circuits described herein are implied or granted to any third party. BURR-BROWN does not authorize or warrant any BURR-BROWN product for use in life support devices and/or systems.

CONNECTION DIAGRAM

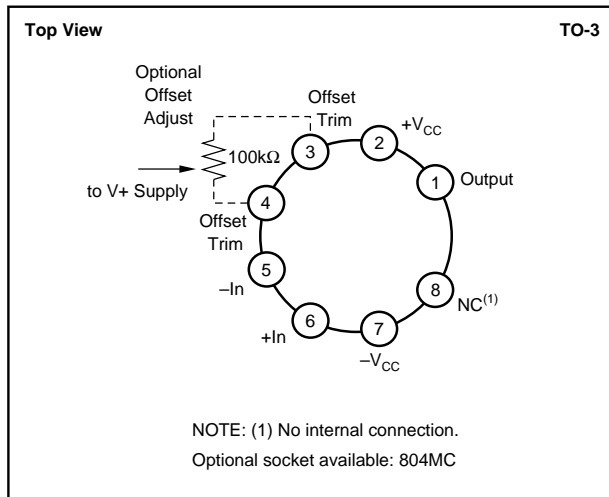

PACKAGING INFORMATION

MODEL	PACKAGE	PACKAGE DRAWING NUMBER ⁽¹⁾
3583AM	8-Pin TO 3	030
3583JM	8-Pin TO 3	030

NOTE: (1) For detailed drawing and dimension table, please see end of data sheet, or Appendix D of Burr-Brown IC Data Book.

ORDERING INFORMATION

MODEL	PACKAGE	TEMPERATURE RANGE
3583AM	8-Pin TO-3	-25°C to +85°C
3583JM	8-Pin TO-3	0°C to +70°C

TYPICAL PERFORMANCE CURVES

T_{CASE} = +25°C, ±V_{CC} = 150VDC, unless otherwise noted.

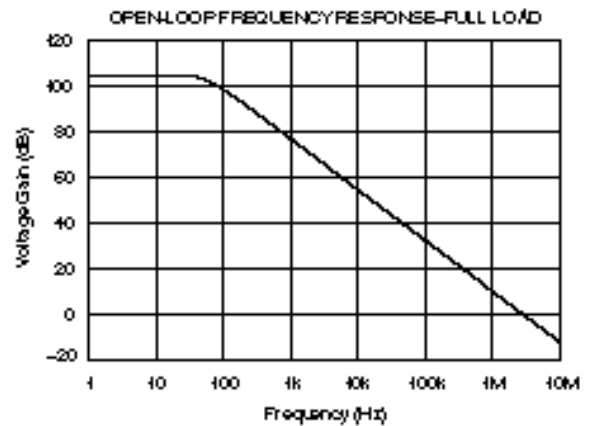
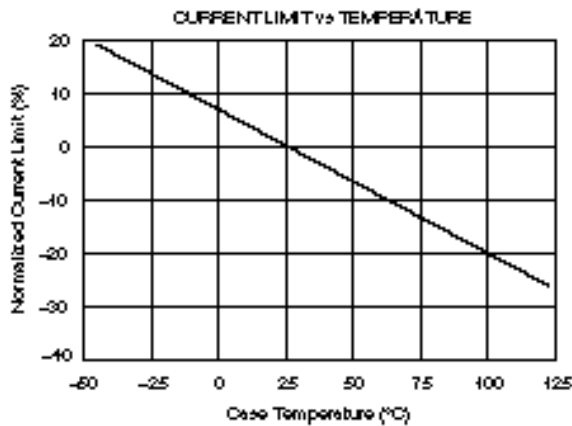
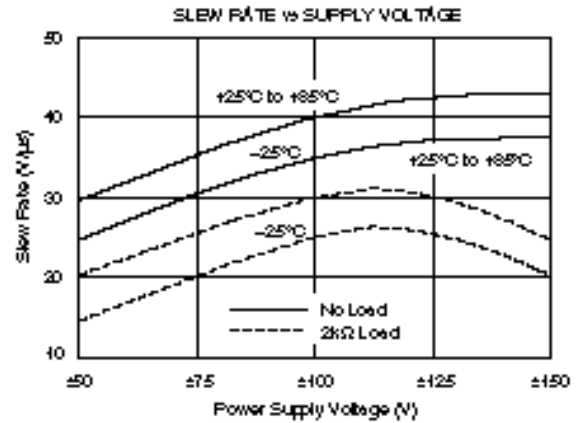
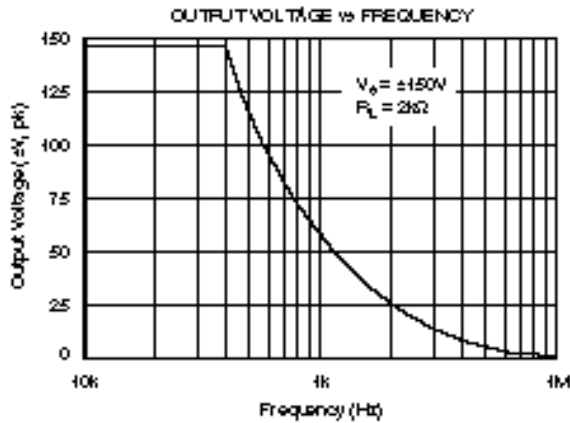

TYPICAL PERFORMANCE CURVES

$T_{CASE} = +25^{\circ}\text{C}$, $\pm V_{CC} = 150\text{VDC}$, unless otherwise noted.

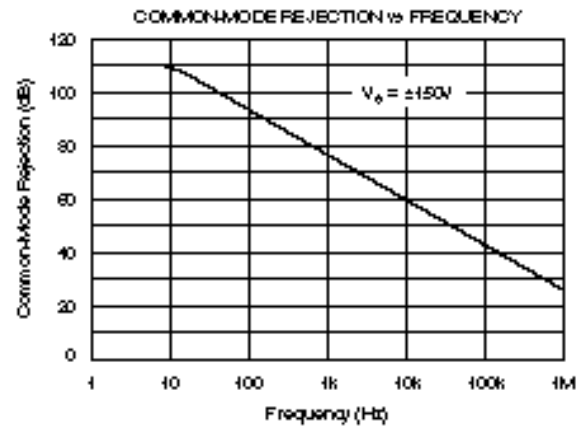
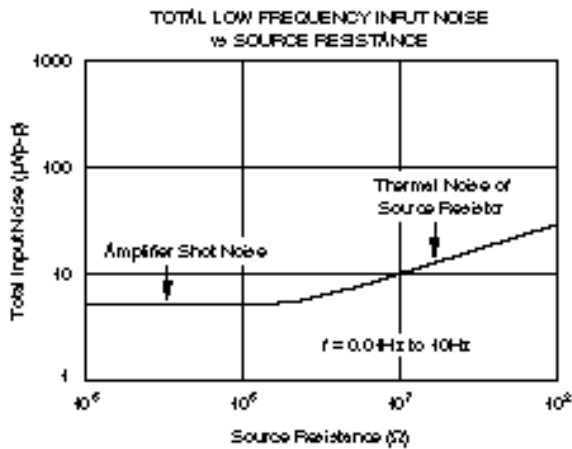
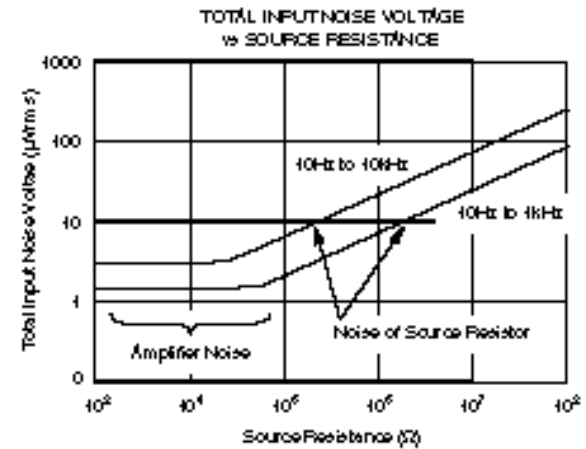
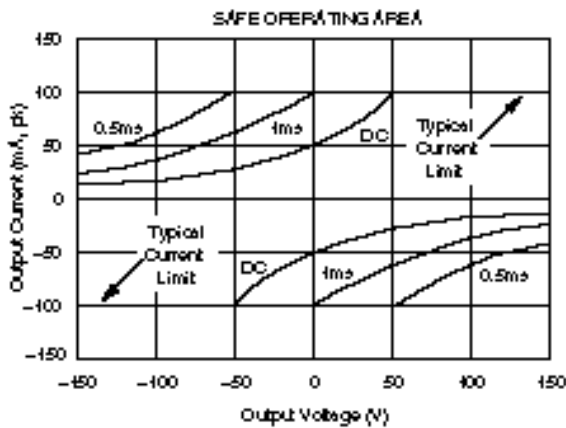
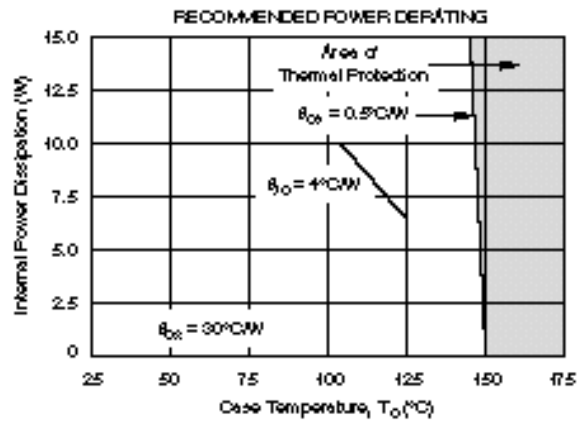
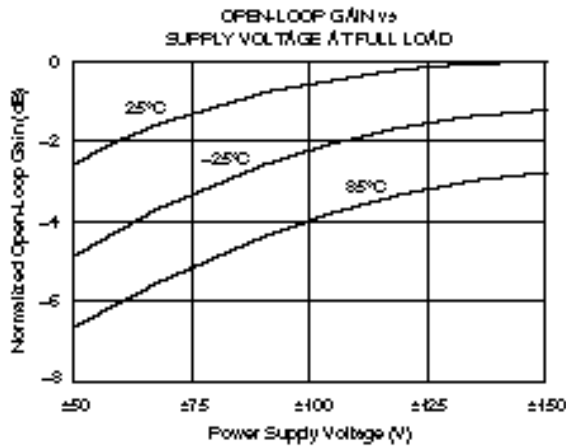

TYPICAL PERFORMANCE CURVES (CONT)

T_{CASE} = +25°C, ±V_{CC} = 150VDC, unless otherwise noted.

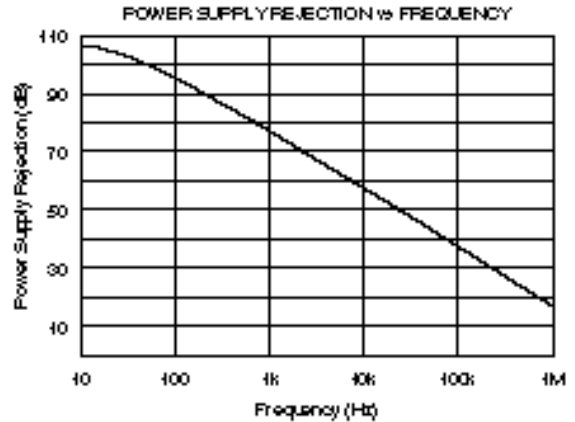
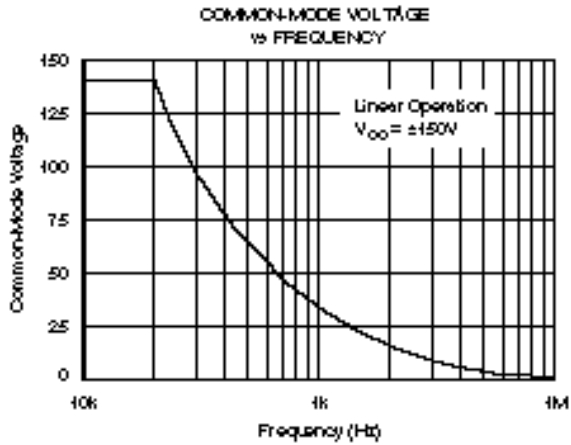

APPLICATION INFORMATION

Figure 1 shows the basic connections required to operate the 3583. Power supply bypass capacitors should be connected close to the device pins. Be sure that these capacitors have an adequate voltage rating.

Input offset voltage and drift of the 3583 are laser-trimmed. Many applications require no external offset trimming. Figure 1 also shows connection of an optional offset trim potentiometer connected to pins 3 and 4.

FET input circuitry reduces the input bias current of the 3583 to less than 20pA at room temperature. Input bias current remains nearly constant throughout the full common-mode range. Input bias current approximately doubles for each 10°C increase in case temperature above 25°C. Heat sinking can help minimize this effect by reducing the case temperature.

Input circuitry of the 3583 is protected with series limiting resistors and input clamp diodes. The inputs can withstand the full rated supply voltage of ±150V (common-mode or differential).

THERMAL PROTECTION

The 3583 has internal thermal shut-down circuitry that activates at a case temperature of approximately 150°C or higher. As this circuitry is activated, the output current drive is reduced. As the case temperature returns to less than the activation temperature, operation will return to normal. A heat sink may be required depending on load and signal conditions.

Note that a 75mA output may not be safe for all output voltages—see typical performance curve “Safe Operating Area”. Applications such as current sources where output voltage may be low (or the opposite polarity of the output current) can overstress the output stage.

The thermal shut-down circuit will normally protect the amplifier during a short-circuit to ground. It will not protect against short-circuit to one of the power supplies. The typical performance curve “Safe Operating Area” shows that the large stress occurring during this high voltage condition may cause damage if it exceeds 5ms duration. The thermal protection circuitry will not activate fast enough to protect the device from short-circuits to one of the power supplies.

The package case of the 3583 is electrically isolated from all circuitry. No special insulating hardware is required. Although not absolutely required, it is recommended that the case be connected to ground.

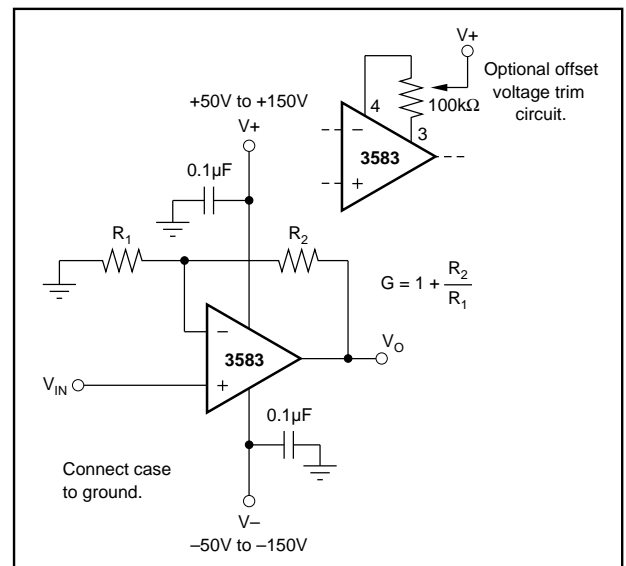

FIGURE 1. Basic Circuit Connections.

IMPORTANT NOTICE

Texas Instruments and its subsidiaries (TI) reserve the right to make changes to their products or to discontinue any product or service without notice, and advise customers to obtain the latest version of relevant information to verify, before placing orders, that information being relied on is current and complete. All products are sold subject to the terms and conditions of sale supplied at the time of order acknowledgment, including those pertaining to warranty, patent infringement, and limitation of liability.

TI warrants performance of its semiconductor products to the specifications applicable at the time of sale in accordance with TI's standard warranty. Testing and other quality control techniques are utilized to the extent TI deems necessary to support this warranty. Specific testing of all parameters of each device is not necessarily performed, except those mandated by government requirements.

Customers are responsible for their applications using TI components.

In order to minimize risks associated with the customer's applications, adequate design and operating safeguards must be provided by the customer to minimize inherent or procedural hazards.

TI assumes no liability for applications assistance or customer product design. TI does not warrant or represent that any license, either express or implied, is granted under any patent right, copyright, mask work right, or other intellectual property right of TI covering or relating to any combination, machine, or process in which such semiconductor products or services might be or are used. TI's publication of information regarding any third party's products or services does not constitute TI's approval, warranty or endorsement thereof.